

Programming Guide

for

**ZPL II
ZBI 2
Set-Get-Do**

**Mirror
WML**



© 2014 ZIH Corp. The copyrights in this manual and the software and/or firmware in the printer described therein are owned by ZIH Corp. and Zebra's licensors. Unauthorized reproduction of this manual or the software and/or firmware in the printer may result in imprisonment of up to one year and fines of up to \$10,000 (17 U.S.C.506). Copyright violators may be subject to civil liability.

This product may contain ZPL[®], ZPL II[®], and Link-OS[™] programs; Element Energy Equalizer[™] Circuit; E^{3™}; and Monotype Imaging fonts. Software © ZIH Corp. All rights reserved worldwide.

Zebra, the Zebra head graphic, Link-OS, ZPL, and ZPL II, are trademarks of ZIH Corp., registered in many jurisdictions worldwide. All rights reserved. All other brand names, product names, or trademarks belong to their respective holders. For additional trademark information, please see "Trademarks" on the product CD.

Proprietary Statement This manual contains proprietary information of Zebra Technologies Corporation and its subsidiaries ("Zebra Technologies"). It is intended solely for the information and use of parties operating and maintaining the equipment described herein. Such proprietary information may not be used, reproduced, or disclosed to any other parties for any other purpose without the express, written permission of Zebra Technologies.

Product Improvements Continuous improvement of products is a policy of Zebra Technologies. All specifications and designs are subject to change without notice.

Liability Disclaimer Zebra Technologies takes steps to ensure that its published Engineering specifications and manuals are correct; however, errors do occur. Zebra Technologies reserves the right to correct any such errors and disclaims liability resulting therefrom.

Limitation of Liability In no event shall Zebra Technologies or anyone else involved in the creation, production, or delivery of the accompanying product (including hardware and software) be liable for any damages whatsoever (including, without limitation, consequential damages including loss of business profits, business interruption, or loss of business information) arising out of the use of, the results of use of, or inability to use such product, even if Zebra Technologies has been advised of the possibility of such damages. Some jurisdictions do not allow the exclusion or limitation of incidental or consequential damages, so the above limitation or exclusion may not apply to you.

rapidJson Library Copyright © 2011 Milo Yip

Permission is hereby granted, free of charge, to any person obtaining a copy of this software and associated documentation files (the "Software"), to deal in the Software without restriction, including without limitation the rights to use, copy, modify, merge, publish, distribute, sublicense, and/or sell copies of the Software, and to permit persons to whom the Software is furnished to do so, subject to the following conditions:

The above copyright notice and this permission notice shall be included in all copies or substantial portions of the Software.

THE SOFTWARE IS PROVIDED "AS IS", WITHOUT WARRANTY OF ANY KIND, EXPRESS OR IMPLIED, INCLUDING BUT NOT LIMITED TO THE WARRANTIES OF MERCHANTABILITY, FITNESS FOR A PARTICULAR PURPOSE AND NONINFRINGEMENT. IN NO EVENT SHALL THE AUTHORS OR COPYRIGHT HOLDERS BE LIABLE FOR ANY CLAIM, DAMAGES OR OTHER LIABILITY, WHETHER IN AN ACTION OF CONTRACT, TORT OR OTHERWISE, ARISING FROM, OUT OF OR IN CONNECTION WITH THE SOFTWARE OR THE USE OR OTHER DEALINGS IN THE SOFTWARE.

libCurl Library COPYRIGHT AND PERMISSION NOTICE Copyright © 1996 - 2012, Daniel Stenberg, <daniel@haxx.se>. All rights reserved. Permission to use, copy, modify, and distribute this software for any purpose with or without fee is hereby granted, provided that the above copyright notice and this permission notice appear in all copies. THE SOFTWARE IS PROVIDED "AS IS", WITHOUT WARRANTY OF ANY KIND, EXPRESS OR IMPLIED, INCLUDING BUT NOT LIMITED TO THE WARRANTIES OF MERCHANTABILITY, FITNESS FOR A PARTICULAR PURPOSE AND NONINFRINGEMENT OF THIRD PARTY RIGHTS. IN NO EVENT SHALL THE AUTHORS OR COPYRIGHT HOLDERS BE LIABLE FOR ANY CLAIM, DAMAGES OR OTHER LIABILITY, WHETHER IN AN ACTION OF CONTRACT, TORT OR OTHERWISE, ARISING FROM, OUT OF OR IN CONNECTION WITH THE SOFTWARE OR THE USE OR OTHER DEALINGS IN THE SOFTWARE. Except as contained in this notice, the name of a copyright holder shall not be used in advertising or otherwise to promote the sale, use or other dealings in this Software without prior written authorization of the copyright holder.

Contents

Functional List of ZPL Commands	29
Alphabetical List of ZBI Commands	33
Alphabetical List of Set/Get/Do Commands	35
About This Document	41
Introduction	42
Who Should Use This Document	42
How This Document Is Organized	43
Contacts	44
Document Conventions	45
Icons Used	45
ZPL Commands	47
Basic ZPL Exercises and Examples	48
Before you begin	49
^A Scalable/Bitmapped Font	58
^A@ Use Font Name to Call Font	60
^B0 Aztec Bar Code Parameters	62
^B1 Code 11 Bar Code	64
^B2 Interleaved 2 of 5 Bar Code	66
^B3 Code 39 Bar Code	68
^B4 Code 49 Bar Code	72
^B5 Planet Code bar code	76
^B7 PDF417 Bar Code	77
^B8 EAN-8 Bar Code	81
^B9 UPC-E Bar Code	83
^BA Code 93 Bar Code	85
^BB CODABLOCK Bar Code	89
^BC Code 128 Bar Code (Subsets A, B, and C)	93

^BD UPS MaxiCode Bar Code	105
^BE EAN-13 Bar Code	108
^BF MicroPDF417 Bar Code	110
^BI Industrial 2 of 5 Bar Codes	112
^BJ Standard 2 of 5 Bar Code	114
^BK ANSI Codabar Bar Code	116
^BL LOGMARS Bar Code	118
^BM MSI Bar Code	120
^BO Aztec Bar Code Parameters	122
^BP Plessey Bar Code	124
^BQ QR Code Bar Code	126
^BR GS1 Databar	134
^BS UPC/EAN Extensions	136
^BT TLC39 Bar Code	139
^BU UPC-A Bar Code	141
^BX Data Matrix Bar Code	143
^BY Bar Code Field Default	147
^CC ~CC Change Caret	148
^BZ POSTAL Bar Code	149
^CD ~CD Change Delimiter	151
^CF Change Alphanumeric Default Font	152
^CI Change International Font/Encoding	153
^CM Change Memory Letter Designation	157
^CN Cut Now	159
^CO Cache On	160
^CP Remove Label	162
^CT ~CT Change Tilde	163
^CV Code Validation	164
^CW Font Identifier	166
~DB Download Bitmap Font	168
~DE Download Encoding	170
^DF Download Format	172
~DG Download Graphics	173
~DN Abort Download Graphic	176
~DS Download Intellifont (Scalable Font)	177
~DT Download Bounded TrueType Font	178
~DU Download Unbounded TrueType Font	179
~DY Download Objects	180
~EG Erase Download Graphics	184
^FB Field Block	185
^FC Field Clock	188
^FD Field Data	189
^FH Field Hexadecimal Indicator	190
^FL Font Linking	192
^FM Multiple Field Origin Locations	195

^FN Field Number	198
^FO Field Origin	199
^FP Field Parameter	200
^FR Field Reverse Print	201
^FS Field Separator	202
^FT Field Typeset	203
^FV Field Variable	205
^FW Field Orientation	206
^FX Comment	208
^GB Graphic Box	209
^GC Graphic Circle	211
^GD Graphic Diagonal Line	212
^GE Graphic Ellipse	213
^GF Graphic Field	214
^GS Graphic Symbol	216
~HB Battery Status	217
~HD Head Diagnostic	218
^HF Host Format	219
^HG Host Graphic	220
^HH Configuration Label Return	221
~HI Host Identification	222
~HM Host RAM Status	223
~HQ Host Query	224
~HQ Examples	227
~HS Host Status Return	232
^HT Host Linked Fonts List	236
~HU Return ZebraNet Alert Configuration	237
^HV Host Verification	238
^HW Host Directory List	239
^HY Upload Graphics	241
^HZ Display Description Information	242
^ID Object Delete	244
^IL Image Load	246
^IM Image Move	247
^IS Image Save	248
~JA Cancel All	250
^JB Initialize Flash Memory	251
~JB Reset Optional Memory	252
~JC Set Media Sensor Calibration	253
~JD Enable Communications Diagnostics	254
~JE Disable Diagnostics	255
~JF Set Battery Condition	256
~JG Graphing Sensor Calibration	257
^JH Early Warning Settings	258
^JI Start ZBI (Zebra BASIC Interpreter)	261

~JI Start ZBI (Zebra BASIC Interpreter)	263
^JJ Set Auxiliary Port	264
~JL Set Label Length	266
^JM Set Dots per Millimeter	267
~JN Head Test Fatal	268
~JO Head Test Non-Fatal	269
~JP Pause and Cancel Format	270
~JQ Terminate Zebra BASIC Interpreter	271
~JR Power On Reset	272
^JS Sensor Select	273
~JS Change Backfeed Sequence	274
^JT Head Test Interval	276
^JU Configuration Update	277
^JW Set Ribbon Tension	278
~JX Cancel Current Partially Input Format	279
^JZ Reprint After Error	280
~KB Kill Battery (Battery Discharge Mode)	281
^KD Select Date and Time Format (for Real Time Clock)	282
^KL Define Language	283
^KN Define Printer Name	284
^KP Define Password	285
^KV Kiosk Values	286
^LF List Font Links	290
^LH Label Home	291
^LL Label Length	292
^LR Label Reverse Print	293
^LS Label Shift	294
^LT Label Top	295
^MA Set Maintenance Alerts	296
^MC Map Clear	298
^MD Media Darkness	299
^MF Media Feed	300
^MI Set Maintenance Information Message	301
^ML Maximum Label Length	302
^MM Print Mode	303
^MN Media Tracking	305
^MP Mode Protection	306
^MT Media Type	308
^MU Set Units of Measurement	309
^MW Modify Head Cold Warning	311
^NC Select the Primary Network Device	312
~NC Network Connect	313
^ND Change Network Settings	314
^NI Network ID Number	316
~NR Set All Network Printers Transparent	317

^NS Change Wired Networking Settings	318
~NT Set Currently Connected Printer Transparent	320
^PA Advanced Text Properties	321
^PF Slew Given Number of Dot Rows	322
^PH ~PH Slew to Home Position	323
~PL Present Length Addition	324
^PM Printing Mirror Image of Label	325
^PN Present Now	326
^PO Print Orientation	327
^PP ~PP Programmable Pause	328
^PQ Print Quantity	329
~PR Applicator Reprint	330
^PR Print Rate	331
~PS Print Start	333
^PW Print Width	334
~RO Reset Advanced Counters	335
^SC Set Serial Communications	336
~SD Set Darkness	337
^SE Select Encoding Table	338
^SF Serialization Field (with a Standard ^FD String)	339
^SI Set Sensor Intensity	342
^SL Set Mode and Language (for Real-Time Clock)	343
^SN Serialization Data	345
^SO Set Offset (for Real-Time Clock)	348
^SP Start Print	349
^SQ Halt ZebraNet Alert	351
^SR Set Printhead Resistance	352
^SS Set Media Sensors	353
^ST Set Date and Time (for Real-Time Clock)	355
^SX Set ZebraNet Alert	356
^SZ Set ZPL Mode	358
~TA Tear-off Adjust Position	359
^TB Text Blocks	360
^TO Transfer Object	361
~WC Print Configuration Label	363
^WD Print Directory Label	364
~WQ Write Query	365
~WQ Examples	367
^XA Start Format	372
^XB Suppress Backfeed	373
^XF Recall Format	374
^XG Recall Graphic	375
^XS Set Dynamic Media Calibration	376
^XZ End Format	377
^ZZ Printer Sleep	378

ZPL RFID Commands	379
RFID Command Overview	380
Printer and Firmware Compatibility	380
^HL or ~HL Return RFID Data Log to Host	385
^HR Calibrate RFID Tag Position	387
^RA Read AFI or DSFID Byte	394
^RB Define EPC Data Structure	395
^RE Enable/Disable E.A.S. Bit	397
^RF Read or Write RFID Format	398
^RI Get RFID Tag ID	402
^RL Lock/Unlock RFID Tag Memory	403
^RLM – Lock/Unlock the Specified Memory Bank	403
^RLB – Permanently Lock Specified Memory Sections	404
^RM Enable RFID Motion	405
^RN Detect Multiple RFID Tags in Encoding Field	406
^RQ Quick Write EPC Data and Passwords	407
^RR Specify RFID Retries for a Block or Enable Adaptive Antenna Selection	409
^RS Set Up RFID Parameters	411
^RT Read RFID Tag	418
^RU Read Unique RFID Chip Serialization	420
~RV Report RFID Encoding Results	422
^RW Set RF Power Levels for Read and Write	423
^RZ Set RFID Tag Password and Lock Tag	427
^WF Encode AFI or DSFID Byte	429
^WT Write (Encode) Tag	430
^WV Verify RFID Encoding Operation	432
ZPL Wireless Commands	433
^KC Set Client Identifier (Option 61)	434
^NB Search for Wired Print Server during Network Boot	435
^NN Set SNMP	436
^NP Set Primary/Secondary Device	437
^NT Set SMTP	438
^NW Set Web Authentication Timeout Value	439
^WA Set Antenna Parameters	440
^WE Set WEP Mode	441
^WI Change Wireless Network Settings	443
^WL Set LEAP Parameters	445
~WL Print Network Configuration Label	446
^WP Set Wireless Password	447
^WR Set Transmit Rate	448
~WR Reset Wireless Radio Card and Print Server	449
^WS Set Wireless Radio Card Values	450

^WX Configure Wireless Securities	452
Supporting Parameters for Different Security Types	455
ZBI Commands	461
Command and Function Reference Format	462
Function Rules	463
Introduction to Zebra Basic Interpreter (ZBI)	464
What is ZBI and why is it for me?	464
Printers, ZBI Keys, & ZBI Versions	465
Section Organization	467
Writing ZBI Programs	467
Editing Commands	468
NEW	469
REM	470
! (EXCLAMATION MARK)	471
LIST	472
AUTONUM	473
RENUM	474
ECHO	475
Running and Debugging Commands	476
RUN	478
CTRL-C	479
RESTART	480
STEP	481
DEBUG	482
TRACE	483
BREAK	484
ADDBREAK	485
DELBREAK	486
ZPL	488
Base Types and Expressions	489
Variable Names	490
Variable Declarations	491
Constants	491
Arrays	491
Assignment	493
LET	494
Numeric Expressions	495
String Concatenation (&)	497
Sub-strings	497
Boolean Expressions	499
Combined Boolean Expressions	501
Control and Flow	502
IF Statements	503

DO Loops	504
FOR Loops	505
GOTO/GOSUB	506
SUB	507
EXIT	508
END	509
Input and Output	510
Available Ports	511
Creating Connections	511
OPEN	512
CLOSE	513
DATAREADY	514
SERVERSOCKET	515
SERVERCLOSE	516
CLIENTSOCKET	517
ACCEPT	518
Reading and Writing	519
INPUT	520
PRINT	521
OUTBYTE	522
INBYTE	523
READ	524
WRITE	525
SEARCHTO\$	526
Port Usage Examples	528
File System	533
Runtime Access	533
STORE	536
LOAD	537
DIR	538
DELETE	539
Comma Separated Values (CSV)	540
Accessing Comma Separated Value (CSV) and Text File Functions	540
CSVLOAD	541
CSVSTORE	543
TXTLOAD	544
TXTSTORE	545
Events	546
Available Events	547
ZBI Key Names	549
REGISTEREVENT	551
UNREGISTEREVENT	553
HANDLEEVENT	554
TRIGGEREVENT	556

Systems	557
ISERROR	558
ISWARNING	559
SLEEP	560
SETERR	561
CLRERR	562
ON ERROR	563
Applicator Functions	564
AUXPORT_STEALPIN	565
AUXPORT_SETPIN	566
AUXPORT_GETPIN	567
AUXPORT_RELEASEPIN	568
String Functions	569
LCASE\$	570
CHR\$	571
LTRIM\$	572
REPEAT\$	573
RTRIM\$	574
SPLIT	575
SPLITCOUNT	578
UCASE\$	579
EXTRACT\$	580
ORD	582
POS	583
LEN	584
Math Functions	585
STR\$	586
MAX	587
MIN	588
MAXNUM	589
MOD	590
VAL	591
INTTOHEX\$	592
HEXTOINT	593
Array Functions	594
REDIM	595
INSERTROW	596
DELROW	597
ROWSIZE	598
COLUMNSIZE	599
FIND	600
Time and Date Functions	602
DATE\$	603
TIME\$	604
DATE	605

TIME	606
Set/Get/Do Interactions	607
SETVAR	608
GETVAR\$	609
Example Programs	610
Array Program	610
CSV Program	612
DPI Conversion Program	616
Email Program	620
Extraction 1 Program	621
Extraction 2 Program	622
Front Panel Control	624
Recall Program	626
Scale Program	628
SGD Printer Commands	631
Overview	633
setvar Command	633
getvar Command	634
do Command	634
Command Structure	635
How to Send Multiple SGD Commands	635
JSON (JavaScript Object Notation)	636
Configuring JSON Usage for Communications	636
alerts.add	640
alerts.conditions	642
alerts.configured	643
alerts.destinations	644
alerts.http.authentication.add	645
alerts.http.authentication.entries	647
alerts.http.authentication.remove	648
alerts.http.logging.clear	649
alerts.http.logging.entries	650
alerts.http.logging.max_entries	651
alerts.http.proxy	652
alerts.tracked_settings.log_tracked	654
alerts.tracked_settings.clear_log	655
alerts.tracked_sgds.log	656
alerts.tracked_sgds.max_log_entries	657
alerts.tracked_sgds.zbi_notified	658
apl.version	659
appl.link_os_version	660
appl.option_board_version	661
appl.bootblock	662

appl.date	663
appl.name	664
capture.channel1.count	665
capture.channel1.data.mime	666
capture.channel1.data.raw	667
capture.channel1.delimiter	668
capture.channel1.max_length	669
capture.channel1.port	670
CISDFCRC16	672
Download Files	672
comm.baud	674
comm.halt	675
comm.pnp_option	676
comm.type	677
comm.parity	678
comm.stop_bits	679
cutter.clean_cutter	680
device.applicator.data_ready	681
device.applicator.end_print	682
device.applicator.feed	683
device.applicator.media_out	684
device.applicator.pause	685
device.applicator.reprint	686
device.applicator.rfid_void	687
device.applicator.ribbon_low	688
device.applicator.ribbon_out	689
device.applicator.service_required	690
device.applicator.start_print	691
device.command_override.active	692
device.command_override.add	693
device.command_override.clear	694
device.command_override.list	695
device.company_contact	696
device.cpcl_synchronous_mode	697
device.cutter_installed	698
device.download_connection_timeout	699
device.epi_legacy_mode	700
device.friendly_name	702
device.frontpanel.feedenabled	703
device.frontpanel.key_press	704
device.frontpanel.line1	705
device.frontpanel.line2	706
device.frontpanel.xml	707
device.host_identification	708
device.host_status	709

device.internal_wired_setting_location	713
device.jobs_print	714
device.languages	715
device.light.cover_open_brightness	716
device.light.head_open_brightness	717
device.ltu_installed	718
device.orientation	719
device.pause	720
device.pnp_option	721
device.position.accuracy	722
device.position.altitude	723
device.position.latitude	724
device.position.longitude	725
device.print_reprogram_2key	726
device.reset	727
device.restore_defaults	728
device.slot_1	729
device.slot_2	730
device.super_host_status	731
device.syslog.clear_log	732
device.syslog.configuration	733
device.syslog.enable	735
device.syslog.entries	736
device.syslog.log_max_file_size	737
device.syslog.save_local_file	738
device.unique_id	739
device.unpause	740
device.uptime	741
device.user_p1	742
device.user_p2	743
device.user_vars.create	744
device.user_vars.set_range	746
device.xml.enable	747
display.backlight	748
display.backlight_on_time	749
display.language	750
display.load_card	751
display.text	752
ezpl.head_close_action	753
ezpl.label_length_max	754
ezpl.label_sensor	755
ezpl.manual_calibration	756
ezpl.media_type	757
ezpl.power_up_action	758
ezpl.print_method	759

ezpl.print_width	760
ezpl.reprint_mode	761
ezpl.take_label	762
ezpl.tear_off	763
file.delete	764
file.dir	765
file.dir_format	766
file.type	767
file.run	768
formats.cancel_all	769
head.latch	770
input.capture	771
interface.network.active.arp_interval	772
interface.network.active.cable_type	773
interface.network.active.dhcp_received_host_name	774
interface.network.active.gateway	775
interface.network.active.ip_addr	776
interface.network.active.mac_addr	777
interface.network.active.mac_raw	778
interface.network.active.netmask	779
interface.network.active.protocol	780
interface.network.active.protocol_error	781
interface.network.active.rx_errors	782
interface.network.active.rx_packets	783
interface.network.active.server_address	784
interface.network.active.protocol_error	785
interface.network.active.speed	786
interface.network.active.tx_errors	787
interface.network.active.tx_packets	788
interface.network.active.wins_addr	789
media.cartridge.part_number	790
media.cut_now	791
media.darkness_mode	792
media.draft_mode	793
media.media_low.external	794
media.media_low.warning	795
media.present.cut_amount	796
media.present.eject	797
media.present.length_addition	798
media.present.loop_length	799
media.present.loop_length_max	800
media.present.cut_margin	801
media.present.present_timeout	802
media.present.present_type	803
media.printmode	804

media.speed	806
memory.flash_free	807
memory.flash_size	808
memory.ram_free	809
memory.ram_size	810
netmanage.avalanche.agent_addr	811
netmanage.avalanche.available_agent	812
netmanage.avalanche.available_port	813
netmanage.avalanche.encryption_type	814
netmanage.avalanche.interval	815
netmanage.avalanche.interval_update	816
netmanage.avalanche.model_name	817
netmanage.avalanche.set_property	818
netmanage.avalanche.startup_update	819
netmanage.avalanche.tcp_connection_timeout	820
netmanage.avalanche.text_msg.beep	821
netmanage.avalanche.text_msg.display	822
netmanage.avalanche.text_msg.print	823
netmanage.avalanche.udp_timeout	824
odometer.headclean	825
odometer.headnew	826
odometer.label_dot_length	827
odometer.media_marker_count1	828
odometer.media_marker_count2	829
odometer.retracts_count	830
odometer.total_print_length	831
odometer.rfid.valid_resetable	832
odometer.rfid.void_resetable	833
parallel_port.mode	834
parallel_port.present	835
power.dtr_power_off	836
print.tone	837
rfid.adaptive_antenna	838
rfid.antenna_sweep	839
rfid.country_code	840
rfid.enable	841
rfid.error.response	842
rfid.hop_table_version	843
rfid.position.program	844
rfid.reader_1.antenna_port	845
rfid.reader_1.power.read	847
rfid.reader_1.power.write	848
rfid.reader_1.power.single_power	849
rfid.reader_1.firmware_version	850
rfid.reader_1.hardware_version	851

rfid.reader_1.model	852
rfid.region_code	853
rfid.tag.calibrate	854
rfid.tag.data	855
rfid.tag.read.content	856
rfid.tag.read.execute	857
rfid.tag.read.result_line1	858
rfid.tag.read.result_line2	859
rfid.tag.read.result_line1_alternate	860
rfid.tag.read.result_line2_alternate	861
rfid.tag.test	862
rfid.tag.test.content	863
rfid.tag.test.execute	864
rfid.tag.test.result_line1	865
rfid.tag.test.result_line2	866
rfid.tag.type	867
sensor.cover_open	870
usb.device.device_id_string	871
usb.device.device_unique_id	872
usb.device.device_version	873
usb.device.manufacturer_string	874
usb.device.product_id	875
usb.device.product_string	876
usb.device.serial_string	877
usb.device.vendor_id	878
usb.halt	879
zbi.control.add_breakpoint	880
zbi.control.break	881
zbi.control.clear_breakpoints	882
zbi.control.delete_breakpoint	883
zbi.control.line_number	884
zbi.control.restart	885
zbi.control.run	886
zbi.control.step	887
zbi.control.terminate	888
zbi.control.variable_name	889
zbi.control.variable_value	890
zbi.key	891
zbi.last_error	892
zbi.reseller_key	893
zbi.revision	894
zbi.running_program_name	895
zbi.start_info.execute	896
zbi.start_info.file_name	897
zbi.start_info.memory_alloc	898
zbi.state	899

zpl.caret	900
zpl.control_character	901
zpl.delimiter	902
zpl.label_length	903
zpl.left_position	904
zpl.system_error	905
zpl.system_status	907
zpl.zpl_mode	909
zpl.zpl_override	910
SGD Wired Commands	911
Overview	912
setvar Command	912
getvar Command	912
do Command	913
Command Structure	914
How to Send Multiple SGD Commands	914
external_wired.check	915
external_wired.ip.addr	916
external_wired.ip.arp_interval	917
external_wired.ip.default_addr_enable	918
external_wired.ip.dhcp.cid_all	919
external_wired.ip.dhcp.cid_enable	920
external_wired.ip.dhcp.cid_prefix	921
external_wired.ip.dhcp.cid_suffix	922
external_wired.ip.dhcp.cid_type	923
external_wired.ip.gateway	924
external_wired.ip.netmask	925
external_wired.ip.port	926
external_wired.ip.protocol	927
external_wired.ip.timeout.enable	928
external_wired.ip.timeout.value	929
external_wired.ip.v6.addr	930
external_wired.ip.v6.gateway	931
external_wired.ip.v6.prefix_length	932
external_wired.mac_addr	933
external_wired.mac_raw	934
internal_wired.auto_switchover	935
internal_wired.ip.addr	936
internal_wired.ip.arp_interval	937
internal_wired.ip.default_addr_enable	938
internal_wired.ip.dhcp.cache_ip	939
internal_wired.ip.dhcp.cid_all	940
internal_wired.ip.dhcp.cid_enable	941
internal_wired.ip.dhcp.cid_prefix	942

internal_wired.ip.dhcp.cid_suffix	943
internal_wired.ip.dhcp.cid_type	944
internal_wired.ip.dhcp.lease.last_attempt	945
internal_wired.ip.dhcp.lease.length	946
internal_wired.ip.dhcp.lease.server	947
internal_wired.ip.dhcp.lease.time_left	948
internal_wired.ip.dhcp.option12	949
internal_wired.ip.dhcp.option12_format	950
internal_wired.ip.dhcp.option12_value	951
internal_wired.ip.dhcp.requests_per_session	952
internal_wired.ip.dns.servers	953
internal_wired.ip.gateway	954
internal_wired.ip.netmask	955
internal_wired.ip.port	956
internal_wired.ip.port_alternate	957
internal_wired.ip.port_json_config	958
internal_wired.ip.protocol	959
internal_wired.ip.timeout.enable	960
internal_wired.ip.timeout.value	961
internal_wired.mac_addr	962
internal_wired.mac_raw	963
SGD Wireless Commands	965
Overview	967
setvar Command	967
getvar Command	968
do Command	968
Command Structure	969
How to Send Multiple SGD Commands	969
bluetooth.address	970
bluetooth.afh_map	971
bluetooth.afh_map_curr	972
bluetooth.afh_mode	973
bluetooth.authentication	974
bluetooth.bluetooth_pin	975
bluetooth.date	976
bluetooth.discoverable	977
bluetooth.enable	978
bluetooth.friendly_name	979
bluetooth.local_name	980
bluetooth.minimum_security_mode	981
bluetooth.radio_auto_baud	982
bluetooth.radio_version	983
bluetooth.short_address	984
bluetooth.version	985

card.mac_addr	986
card.inserted	987
ip.active_network	988
ip.addr	989
ip.arp_interval	990
ip.bootp.enable	991
ip.dhcp.arp_verify	992
ip.dhcp.auto_provision_enable	993
ip.dhcp.cache_ip	995
ip.dhcp.cid_all	996
ip.dhcp.cid_enable	997
ip.dhcp.cid_prefix	998
ip.dhcp.cid_suffix	999
ip.dhcp.cid_type	1000
ip.dhcp.cid_value	1001
ip.dhcp.enable	1002
ip.dhcp.lease.last_attempt	1003
ip.dhcp.lease.server	1004
ip.dhcp.lease.time_left	1005
ip.dhcp.option12	1006
ip.dhcp.option12_format	1007
ip.dhcp.option12_value	1008
ip.dhcp.request_timeout	1009
ip.dhcp.requests_per_session	1010
ip.dhcp.session_interval	1011
ip.dhcp.vendor_class_id	1012
ip.dns.domain	1013
ip.dns.servers	1014
ip.ftp.enable	1015
ip.ftp.execute_file	1016
ip.ftp.request_password	1017
ip.gateway	1018
ip.http.admin_name	1019
ip.http.admin_password	1020
ip.http.custom_link_name	1021
ip.http.custom_link_url	1022
ip.http.enable	1023
ip.http.faq_url	1024
ip.http.port	1025
ip.lpd.enable	1026
ip.mac_raw	1027
ip.mirror.appl_path	1028
ip.mirror.auto	1029
ip.mirror.error_retry	1030
ip.mirror.feedback.auto	1031

ip.mirror.feedback.freq	1032
ip.mirror.feedback.odometer	1033
ip.mirror.feedback.path	1034
ip.mirror.fetch	1035
ip.mirror.freq	1036
ip.mirror.freq_hours	1037
ip.mirror.last_error	1038
ip.mirror.last_time	1039
ip.mirror.mode	1040
ip.mirror.password	1041
ip.mirror.path	1042
ip.mirror.reset_delay	1043
ip.mirror.server	1044
ip.mirror.success	1045
ip.mirror.success_time	1046
ip.mirror.username	1047
ip.mirror.version	1048
ip.netmask	1049
ip.pop3.enable	1050
ip.pop3.password	1051
ip.pop3.poll	1052
ip.pop3.server_addr	1053
ip.pop3.username	1054
ip.port	1055
ip.port_alternate	1056
ip.port_json_config	1057
ip.port_json_config	1058
ip.primary_network	1059
ip.smtp.domain	1060
ip.smtp.enable	1061
ip.smtp.server_addr	1062
ip.snmp.get_community_name	1063
ip.snmp.set_community_name	1064
ip.snmp.trap_community_name	1065
ip.snmp.enable	1066
ip.telnet.enable	1067
ip.tcp.enable	1068
ip.udp.enable	1069
weblink.enable	1070
weblink.ip.conn[1 2].authentication.add	1071
weblink.ip.conn[1 2].authentication.entries	1073
weblink.ip.conn[1 2].authentication.remove	1074
weblink.ip.conn[1 2].location	1075
weblink.ip.conn[1 2].maximum_simultaneous_	
connections	1076
weblink.ip.conn[1 2].num_connections	1077

weblink.ip.conn[1 2].proxy	1078
weblink.ip.conn[1 2].retry_interval	1080
weblink.ip.conn[1 2].test.location	1081
weblink.ip.conn[1 2].test.retry_interval	1083
weblink.ip.conn[1 2].test.test_on	1084
weblink.logging.clear	1086
weblink.logging.entries	1087
weblink.logging.max_entries	1088
weblink.printer_reset_required	1090
weblink.restore_defaults	1091
wlan.11n.20mhz_only	1092
wlan.11n.aggregation	1093
wlan.11n.greenfield	1094
wlan.11n.rifs	1095
wlan.11n.short_gi_40mhz	1096
wlan.11n.short_gi_20mhz	1097
wlan.8021x.validate_peap_server_certificate	1098
wlan.active_channels	1099
wlan.allowed_band	1100
wlan.adhocautomode	1101
wlan.adhocchannel	1102
wlan.associated	1103
wlan.auth_type	1104
wlan.bssid	1105
wlan.channel	1106
wlan.channel_mask	1107
wlan.country_code	1108
wlan.current_tx_rate	1109
wlan.encryption_index	1110
wlan.encryption_key[1 2 3 4]1	1111
wlan.encryption_mode	1112
wlan.essid	1113
wlan.firmware_version	1114
wlan.ip.addr	1115
wlan.ip.arp_interval	1116
wlan.ip.default_addr_enable	1117
wlan.ip.dhcp.cache_ip	1118
wlan.ip.dhcp.cid_all	1119
wlan.ip.dhcp.cid_enable	1120
wlan.ip.dhcp.cid_prefix	1121
wlan.ip.dhcp.cid_suffix	1122
wlan.ip.dhcp.cid_type	1123
wlan.ip.dhcp.lease.last_attempt	1124
wlan.ip.dhcp.lease.length	1125
wlan.ip.dhcp.lease.server	1126
wlan.ip.dhcp.lease.time_left	1127

wlan.ip.dhcp.option12	1128
wlan.ip.dhcp.option12_format	1129
wlan.ip.dhcp.option12_value	1130
wlan.ip.dhcp.request_timeout	1131
wlan.ip.dhcp.requests_per_session	1132
wlan.ip.dhcp.session_interval	1133
wlan.ip.dns.servers	1134
wlan.ip.gateway	1135
wlan.ip.netmask	1136
wlan.ip.port	1137
wlan.ip.port_alternate	1138
wlan.ip.port_json_config	1139
wlan.ip.protocol	1140
wlan.ip.timeout.enable	1141
wlan.ip.timeout.value	1142
wlan.keep_alive.enable	1143
wlan.keep_alive.timeout	1144
wlan.kerberos.kdc	1145
wlan.kerberos.mode	1146
wlan.kerberos.password	1147
wlan.kerberos.realm	1148
wlan.kerberos.username	1149
wlan.leap_mode	1150
wlan.leap_password	1151
wlan.leap_username	1152
wlan.mac_addr	1153
wlan.mac_raw	1154
wlan.operating_mode	1155
wlan.password	1156
wlan.permitted_channels	1157
wlan.preamble	1158
wlan.private_key_password	1159
wlan.region_code	1160
wlan.roam.interchannel_delay	1161
wlan.roam.interval	1162
wlan.roam.max_chan_scan_time	1163
wlan.roam.max_fail	1164
wlan.roam.rssi	1165
wlan.roam.signal	1166
wlan.security	1167
Supporting SGD Commands for Different Security Types	1168
wlan.signal_noise	1174
wlan.signal_quality	1175
wlan.signal_strength	1176
wlan.station_name	1177

wlan.tx_power	1178
wlan.tx_rate	1179
wlan.user_channel_list	1180
wlan.username	1181
wlan.waveagent.enable	1182
wlan.waveagent.udp_port	1183
wlan.wep.auth_type	1184
wlan.wep.index	1185
wlan.wep.key1	1186
wlan.wep.key2	1187
wlan.wep.key3	1188
wlan.wep.key4	1189
wlan.wpa.psk	1190
wlan.wep.key_format	1191
Zebra Code Pages	1193
Zebra Code Page 850 — Latin Character Set	1194
Zebra Code Page 1250 (Scalable/Downloaded TTF) —Central and Eastern European Latin Character Set	1196
Zebra Code Page 1252— Latin Character Set	1198
Zebra Code Page 1253 — Modern Greek Character Set	1200
Zebra Code Page 1254 — Turkish Character Set	1202
Zebra Code Page 1255 — Hebrew Character Set	1204
ASCII	1207
ASCII Code Chart	1208
Fonts and Bar Codes	1209
Standard Printer Fonts	1210
Proportional and Fixed Spacing	1212
Scalable Versus Bitmapped Fonts	1213
Scalable Fonts	1213
Bitmapped Fonts	1213
Font Matrices	1215
Bar Codes	1217
Basic Format for Bar Codes	1217
Bar Code Field Instructions	1218
Bar Code Command Groups	1220
Mod 10 and Mod 43 Check Digits	1223
Mod 10 Check Digit	1224
Mod 43 Check Digit	1225
Error Detection Protocol	1227

Introduction	1228
What is a Protocol?	1228
How Protocols Work	1228
Request Packet Formats from the Host Computer	1229
Header Block Fields	1229
Data Block Fields	1230
Response From the Zebra Printer	1231
Zebra Packet Response	1231
Header Block Fields	1231
Data Block Fields	1232
Disguising Control Code Characters	1233
Error Detection Protocol Application	1234
Error Conditions and System Faults	1234
How the Zebra Printer Processes a Request Packet	1235
How the Zebra Printer Responds to Host Status	1236
ZB64 Encoding and Compression	1237
Introduction to B64 and Z64	1238
B64 and Z64 Encoding	1240
206 • Field Interactions	1243
Normal Orientation	1244
Rotated Orientation	1245
Bottom Up Orientation	1246
Inverted Orientation	1247
Real Time Clock	1249
Overview	1250
Control Panel Programming	1251
Real Time Clock Parameters	1251
RTC Date	1252
RTC Time	1253
RTC General Information	1254
First Day of the Week Affects Calendar Week	1256
Time and Date Precision	1258
ZPL II Samples	1260
ZBI Character Set	1263
Character Set	1264
SGD Command Support	1267
Printer and Firmware Compatibility	1268
Firmware Features	1309
Firmware x.17	1310
Firmware x.16	1311

Firmware x.15	1313
Wireless Securities	1313
ZPL and SGD Commands	1313
SNMP	1314
Set / Get / Do Support	1314
XML-Enabled Printing	1314
Firmware x.14	1315
Global Printing Solution	1316
211 • Mirror	1319
Mirror Overview	1320
Benefits	1320
Professional Services for Mirror Configuration	1321
Requirements	1322
How Mirror Works	1324
Mirror Process Summary	1324
Mirror Process Details	1325
Creating ZPL Files for Use in the "<update-root>/files" Directory	1326
One Format per File	1326
Character Substitution	1327
Removing the ^XA and ^XZ commands	1327
Removing the ^DF command	1328
Example Files	1329
File Naming Recommendations	1329
Command Use Recommendations	1329
Configuration	1330
Mirror FTP Server Configuration	1330
Mirror Printer Configuration	1330
The Feedback.get File	1331
Example Feedback.get file	1332
How to Set Up and Use Mirror	1333
Scenario One	1333
Scenario Two	1334
Troubleshooting	1335
Wireless Markup Language (WML)	1339
WML Overview	1340
WML Details	1340
Supported Printers	1341
Professional Services for WML Content Creation	1342
WML Tags	1342

Using WML	1342
Send WML Content to the Printer via FTP	1344
Resetting the "ip.ftp.execute_file setting	1345
Sending WML Content to the Printer via the CISDFCRC16 Command:	1345
Retrieving WML Content from the Printer using the file.type Command:	1346
Using .nrd Files from WML Menus	1346
Removing WML or .nrd Files from the Printer using the file.delete Command: ...	1346
WML Examples	1347
Example 1	1347
Example 2	1348
Example 3	1349
Example 4	1351
Example 5	1352
Troubleshooting Scenarios	1355
Using Weblink	1357
What is Weblink and when should it be used?	1357
Configuring Weblink	1358
Basic Configuration	1358
When a Proxy Server is Part of the Network Configuration	1358
When HTTP Authentication is Necessary	1359
Additional Firewall Configuration	1360
Difference Between Conn1 and Conn2	1360
Enable Logging	1360
Navigating the Log Output	1361
SSL/TLS Certificate Errors	1362
Other Typical Errors	1365
Troubleshooting	1366
HTTP Messages	1368
HTTP POST Alerts	1369
Configuring Alerts	
Where the Alert Destination is HTTP POST	1370
How to Parse via PHP	1371
Basic Configuration	1372
When a Proxy Server is Part of the Network Configuration	1372
When HTTP Authentication is Necessary	1373
Enabling Logging	1374
Navigating the Log Output	1375
Understanding Errors in the Alerts HTTP Log	1376
Troubleshooting	1377
HTTP Messages	1378
Glossary	1379



Notes •

Functional List of ZPL Commands

Abort Download Graphic	176	Define Language	283
Advanced Text Properties	321	Define Password	285
ANSI Codabar Bar Code	116	Define Printer Name	284
Applicator Reprint	330	Detect Multiple RFID Tags in Encoding Field	406
Aztec Bar Code Parameters	122	Disable Diagnostics	255
Aztec Bar Code Parameters	62	Display Description Information	242
Bar Code Field Default	147	Download Bitmap Font	168
Battery Status	217	Download Bounded TrueType Font	178
Cache On	160	Download Encoding	170
Calibrate RFID Tag Position	387	Download Files	672
Cancel All	250	Download Format	172
Cancel Current Partially Input Format	279	Download Graphics	173
Change Alphanumeric Default Font	152	Download Intellifont (Scalable Font)	177
Change Backfeed Sequence	274	Download Objects	180
Change Caret	148	Download Unbounded TrueType Font	179
Change Delimiter	151	EAN-13 Bar Code	108
Change International Font/Encoding	153	EAN-8 Bar Code	81
Change Memory Letter Designation	157	Early Warning Settings	258
Change Network Settings	314	Enable Communications Diagnostics	254
Change Tilde	163	Enable RFID Motion	405
Change Wired Networking Settings	318	Enable/Disable E.A.S. Bit	397
Change Wireless Network Settings	443	Encode AFI or DSFID Byte	429
CODABLOCK Bar Code	89	End Format	377
Code 11 Bar Code	64	Erase Download Graphics	184
Code 128 Bar Code (Subsets A, B, and C)	93	Field Block	185
Code 39 Bar Code	68	Field Clock	188
Code 49 Bar Code	72	Field Data	189
Code 93 Bar Code	85	Field Hexadecimal Indicator	190
Code Validation	164	Field Number	198
Comment	208	Field Orientation	206
Configuration Label Return	221	Field Origin	199
Configuration Update	277	Field Parameter	200
Configure Wireless Securities	452	Field Reverse Print	201
Cut Now	159	Field Separator	202
Data Matrix Bar Code	143	Field Typeset	203
Define EPC Data Structure	395	Field Variable	205

Font Identifier	166	Object Delete	244
Font Linking	192	Pause and Cancel Format	270
Get RFID Tag ID	402	PDF417 Bar Code	77
Graphic Box	209	Planet Code bar code	76
Graphic Circle	211	Plessey Bar Code	124
Graphic Diagonal Line	212	POSTAL Bar Code	149
Graphic Ellipse	213	Power On Reset	272
Graphic Field	214	Present Length Addition	324
Graphic Symbol	216	Present Now	326
Graphing Sensor Calibration	257	Print Configuration Label	363
GS1 Databar	134	Print Directory Label	364
Halt ZebraNet Alert	351	Print Mode	303
Head Diagnostic	218	Print Network Configuration Label	446
Head Test Fatal	268	Print Orientation	327
Head Test Interval	276	Print Quantity	329
Head Test Non-Fatal	269	Print Rate	331
Host Directory List	239	Print Start	333
Host Format	219	Print Width	334
Host Graphic	220	Printer Sleep	378
Host Identification	222	Printing Mirror Image of Label	325
Host Linked Fonts List	236	Programmable Pause	328
Host Query	224	QR Code Bar Code	126
Host RAM Status	223	Quick Write EPC Data and Passwords	407
Host Status Return	232	Read AFI or DSFID Byte	394
Host Verification	238	Read or Write RFID Format	398
Image Load	246	Read RFID Tag	418
Image Move	247	Read Unique RFID Chip Serialization	420
Image Save	248	Recall Format	374
Industrial 2 of 5 Bar Codes	112	Recall Graphic	375
Initialize Flash Memory	251	Remove Label	162
Interleaved 2 of 5 Bar Code	66	Report RFID Encoding Results	422
Kill Battery (Battery Discharge Mode)	281	Reprint After Error	280
Kiosk Values	286	Reset Advanced Counters	335
Label Home	291	Reset Optional Memory	252
Label Length	292	Reset Wireless Radio Card and Print Server	449
Label Reverse Print	293	Return RFID Data Log to Host	385
Label Shift	294	Return ZebraNet Alert Configuration	237
Label Top	295	Scalable/Bitmapped Font	58
List Font Links	290	Search for Wired Print Server during Network Boot	435
Lock/Unlock RFID Tag Memory	403	Select Date and Time Format (for Real Time Clock)	282
LOGMARS Bar Code	118	Select Encoding Table	338
Map Clear	298	Select the Primary Network Device	312
Maximum Label Length	302	Sensor Select	273
Media Darkness	299	Serialization Data	345
Media Feed	300	Serialization Field (with a Standard ^FD String)	339
Media Tracking	305	Set All Network Printers Transparent	317
Media Type	308	Set Antenna Parameters	440
MicroPDF417 Bar Code	110	Set Auxiliary Port	264
Mode Protection	306	Set Battery Condition	256
Modify Head Cold Warning	311	Set Client Identifier (Option 61)	434
MSI Bar Code	120	Set Currently Connected Printer Transparent	320
Multiple Field Origin Locations	195		
Network Connect	313		
Network ID Number	316		

Set Darkness	337	Start Print	349
Set Date and Time (for Real-Time Clock)	355	Start ZBI (Zebra BASIC Interpreter)	261
Set Dots per Millimeter	267	Start ZBI (Zebra BASIC Interpreter)	263
Set Dynamic Media Calibration	376	Suppress Backfeed	373
Set Label Length	266	Tear-off Adjust Position	359
Set LEAP Parameters	445	Terminate Zebra BASIC Interpreter	271
Set Maintenance Alerts	296	Text Blocks	360
Set Maintenance Information Message	301	TLC39 Bar Code	139
Set Media Sensor Calibration	253	Transfer Object	361
Set Media Sensors	353	UPC/EAN Extensions	136
Set Mode and Language (for Real-Time Clock)	343	UPC-A Bar Code	141
Set Offset (for Real-Time Clock)	348	UPC-E Bar Code	83
Set Primary/Secondary Device	437	Upload Graphics	241
Set Printhead Resistance	352	UPS MaxiCode Bar Code	105
Set RF Power Levels for Read and Write	423	Use Font Name to Call Font	60
Set RFID Tag Password and Lock Tag	427	Verify RFID Encoding Operation	432
Set Ribbon Tension	278	Write (Encode) Tag	430
Set Sensor Intensity	342	Write Query	365
Set Serial Communications	336		
Set SMTP	438		
Set SNMP	436		
Set Transmit Rate	448		
Set Units of Measurement	309		
Set Up RFID Parameters	411		
Set Web Authentication Timeout Value	439		
Set WEP Mode	441		
Set Wireless Password	447		
Set Wireless Radio Card Values	450		
Set ZebraNet Alert	356		
Set ZPL Mode	358		
Slew Given Number of Dot Rows	322		
Slew to Home Position	323		
Specify RFID Retries for a Block or Enable Adaptive Antenna Selection	409		
Standard 2 of 5 Bar Code	114		
Start Format	372		



Notes • _____

Alphabetical List of ZBI Commands

! (EXCLAMATION MARK)	471	IF Statements	503
ACCEPT	518	INBYTE	523
ADDBREAK	485	INPUT	520
AUTONUM	473	INSERTROW	596
AUXPORT_GETPIN	567	INTTOHEX\$	592
AUXPORT_RELEASEPIN	568	ISERROR	558
AUXPORT_SETPIN	566	ISWARNING	559
AUXPORT_STEALPIN	565	LCASE\$	570
BREAK	484	LEN	584
CHR\$	571	LET	494
CLIENTSOCKET	517	LIST	472
CLOSE	513	LOAD	537
CLRERR	562	LTRIM\$	572
COLUMNSIZE	599	MAX	587
CSVLOAD	541	MAXNUM	589
CSVSTORE	543	MIN	588
CTRL-C	479	MOD	590
DATAREADY	514	NEW	469
DATE	605	ON ERROR	563
DATE\$	603	OPEN	512
DEBUG	482	ORD	582
DELBREAK	486	OUTBYTE	522
DELETE	539	POS	583
DELROW	597	PRINT	521
DIR	538	READ	524
DO Loops	504	REDIM	595
ECHO	475	REGISTEREVENT	551
END	509	REM	470
EXIT	508	RENUM	474
EXTRACT\$	580	REPEAT\$	573
FIND	600	RESTART	480
FOR Loops	505	ROWSIZE	598
GETVAR\$	609	RTRIM\$	574
GOTO/GOSUB	506	RUN	478
HANDLEEVENT	554	SEARCHTO\$	526
HEXTOINT	593	SERVERCLOSE	516

SERVICESOCKET	515
SETERR	561
SETVAR	608
SLEEP	560
SPLIT	575
SPLITCOUNT	578
STEP	481
STORE	536
STR\$	586
SUB	507
TIME	606
TIMES\$	604
TRACE	483
TRIGGEREVENT	556
TXTLOAD	544
TXTSTORE	545
UCASE\$	579
UNREGISTEREVENT	553
VAL	591
WRITE	525
ZPL	488

Alphabetical List of Set/ Get/Do Commands

alerts.add	640	capture.channel1.delimiter	668
alerts.conditions	642	capture.channel1.max_length	669
alerts.configured	643	capture.channel1.port	670
alerts.destinations	644	card.inserted	987
alerts.http.authentication.add	645	card.mac_addr	986
alerts.http.authentication.entries	647	CISDFCRC16	672
alerts.http.authentication.remove	648	comm.baud	674
alerts.http.logging.clear	649	comm.halt	675
alerts.http.logging.entries	650	comm.parity	678
alerts.http.logging.max_entries	651	comm.pnp_option	676
alerts.http.proxy	652	comm.stop_bits	679
alerts.tracked_settings.clear_log	655	comm.type	677
alerts.tracked_settings.log_tracked	654	cutter.clean_cutter	680
alerts.tracked_sgds.log	656	device.applicator.data_ready	681
alerts.tracked_sgds.max_log_entries	657	device.applicator.end_print	682
alerts.tracked_sgds.zbi_notified	658	device.applicator.feed	683
apl.version	659	device.applicator.media_out	684
appl.bootblock	662	device.applicator.pause	685
appl.date	663	device.applicator.reprint	686
appl.link_os_version	660	device.applicator.rfid_void	687
appl.name	664	device.applicator.ribbon_low	688
appl.option_board_version	661	device.applicator.ribbon_out	689
bluetooth.address	970	device.applicator.service_required	690
bluetooth.afh_map	971	device.applicator.start_print	691
bluetooth.afh_map_curr	972	device.command_override.active	692
bluetooth.afh_mode	973	device.command_override.add	693
bluetooth.authentication	974	device.command_override.clear	694
bluetooth.bluetooth_pin	975	device.command_override.list	695
bluetooth.date	976	device.company_contact	696
bluetooth.discoverable	977	device.cpci_synchronous_mode	697
bluetooth.enable	978	device.cutter_installed	698
bluetooth.friendly_name	979	device.download_connection_timeout	699
bluetooth.local_name	980	device.epi_legacy_mode	700
bluetooth.minimum_security_mode	981	device.friendly_name	702
bluetooth.radio_auto_baud	982	device.frontpanel.feedenabled	703
bluetooth.radio_version	983	device.frontpanel.key_press	704
bluetooth.short_address	984	device.frontpanel.line1	705
bluetooth.version	985	device.frontpanel.line2	706
capture.channel1.count	665	device.frontpanel.xml	707
capture.channel1.data.mime	666	device.host_identification	708
capture.channel1.data.raw	667	device.host_status	709

device.internal_wired_setting_location	713	ezpl.media_type	757
device.jobs_print	714	ezpl.power_up_action	758
device.languages	715	ezpl.print_method	759
device.light.cover_open_brightness	716	ezpl.print_width	760
device.light.head_open_brightness	717	ezpl.reprint_mode	761
device.ltu_installed	718	ezpl.take_label	762
device.orientation	719	ezpl.tear_off	763
device.pause	720	file.delete	764
device.pnp_option	721	file.dir	765
device.position.accuracy	722	file.dir_format	766
device.position.altitude	723	file.run	768
device.position.latitude	724	file.type	767
device.position.longitude	725	formats.cancel_all	769
device.print_reprogram_2key	726	head.latch	770
device.reset	727	input.capture	771
device.restore_defaults	728	interface.network.active.arp_interval	772
device.slot_1	729	interface.network.active.cable_type	773
device.slot_2	730	interface.network.active.dhcp_received_host_name	774
device.super_host_status	731	interface.network.active.gateway	775
device.syslog.clear_log	732	interface.network.active.ip_addr	776
device.syslog.configuration	733	interface.network.active.mac_addr	777
device.syslog.enable	735	interface.network.active.mac_raw	778
device.syslog.entries	736	interface.network.active.netmask	779
device.syslog.log_max_file_size	737	interface.network.active.protocol	780
device.syslog.save_local_file	738	interface.network.active.protocol_error	781
device.unique_id	739	interface.network.active.protocol_error	785
device.unpause	740	interface.network.active.rx_errors	782
device.uptime	741	interface.network.active.rx_packets	783
device.user_p1	742	interface.network.active.server_address	784
device.user_p2	743	interface.network.active.speed	786
device.user_vars.create	744	interface.network.active.tx_errors	787
device.user_vars.set_range	746	interface.network.active.tx_packets	788
device.xml.enable	747	interface.network.active.wins_addr	789
display.backlight	748	internal_wired.auto_switchover	935
display.backlight_on_time	749	internal_wired.ip.addr	936
display.language	750	internal_wired.ip.arp_interval	937
display.load_card	751	internal_wired.ip.default_addr_enable	938
display.text	752	internal_wired.ip.dhcp.cache_ip	939
external_wired.check	915	internal_wired.ip.dhcp.cid_all	940
external_wired.ip.addr	916	internal_wired.ip.dhcp.cid_enable	941
external_wired.ip.arp_interval	917	internal_wired.ip.dhcp.cid_prefix	942
external_wired.ip.default_addr_enable	918	internal_wired.ip.dhcp.cid_suffix	943
external_wired.ip.dhcp.cid_all	919	internal_wired.ip.dhcp.cid_type	944
external_wired.ip.dhcp.cid_enable	920	internal_wired.ip.dhcp.lease.last_attempt	945
external_wired.ip.dhcp.cid_prefix	921	internal_wired.ip.dhcp.lease.length	946
external_wired.ip.dhcp.cid_suffix	922	internal_wired.ip.dhcp.lease.server	947
external_wired.ip.dhcp.cid_type	923	internal_wired.ip.dhcp.lease.time_left	948
external_wired.ip.gateway	924	internal_wired.ip.dhcp.option12	949
external_wired.ip.netmask	925	internal_wired.ip.dhcp.option12_format	950
external_wired.ip.port	926	internal_wired.ip.dhcp.option12_value	951
external_wired.ip.protocol	927	internal_wired.ip.dhcp.requests_per_session	952
external_wired.ip.timeout.enable	928	internal_wired.ip.dns.servers	953
external_wired.ip.timeout.value	929	internal_wired.ip.gateway	954
external_wired.ip.v6.addr	930	internal_wired.ip.netmask	955
external_wired.ip.v6.gateway	931	internal_wired.ip.port	956
external_wired.ip.v6.prefix_length	932	internal_wired.ip.port_alternate	957
external_wired.ip.mac_addr	933	internal_wired.ip.port_json_config	958
external_wired.mac_raw	934	internal_wired.ip.protocol	959
ezpl.head_close_action	753	internal_wired.ip.timeout.enable	960
ezpl.label_length_max	754	internal_wired.ip.timeout.value	961
ezpl.label_sensor	755	internal_wired.mac_addr	962
ezpl.manual_calibration	756	internal_wired.mac_raw	963

ip.active_network	988	ip.pop3.password	1051
ip.addr	989	ip.pop3.poll	1052
ip.arp_interval	990	ip.pop3.server_addr	1053
ip.bootp.enable	991	ip.pop3.username	1054
ip.dhcp.arp_verify	992	ip.port	1055
ip.dhcp.auto_provision_enable	993	ip.port_alternate	1056
ip.dhcp.cache_ip	995	ip.port_json_config	1058
ip.dhcp.cid_all	996	ip.port_json_config	1057
ip.dhcp.cid_enable	997	ip.primary_network	1059
ip.dhcp.cid_prefix	998	ip.smtp.domain	1060
ip.dhcp.cid_suffix	999	ip.smtp.enable	1061
ip.dhcp.cid_type	1000	ip.smtp.server_addr	1062
ip.dhcp.cid_value	1001	ip.snmp.enable	1066
ip.dhcp.enable	1002	ip.snmp.get_community_name	1063
ip.dhcp.lease.last_attempt	1003	ip.snmp.set_community_name	1064
ip.dhcp.lease.server	1004	ip.snmp.trap_community_name	1065
ip.dhcp.lease.time_left	1005	ip.tcp.enable	1068
ip.dhcp.option12	1006	ip.telnet.enable	1067
ip.dhcp.option12_format	1007	ip.udp.enable	1069
ip.dhcp.option12_value	1008	media.cartridge.part_number	790
ip.dhcp.request_timeout	1009	media.cut_now	791
ip.dhcp.requests_per_session	1010	media.darkness_mode	792
ip.dhcp.session_interval	1011	media.draft_mode	793
ip.dhcp.vendor_class_id	1012	media.media_low.external	794
ip.dns.domain	1013	media.media_low.warning	795
ip.dns.servers	1014	media.present.cut_amount	796
ip.ftp.enable	1015	media.present.cut_margin	801
ip.ftp.execute_file	1016	media.present.eject	797
ip.ftp.request_password	1017	media.present.length_addition	798
ip.gateway	1018	media.present.loop_length	799
ip.http.admin_name	1019	media.present.loop_length_max	800
ip.http.admin_password	1020	media.present.present_timeout	802
ip.http.custom_link_name	1021	media.present.present_type	803
ip.http.custom_link_url	1022	media.printmode	804
ip.http.enable	1023	media.speed	806
ip.http.faq_url	1024	memory.flash_free	807
ip.http.port	1025	memory.flash_size	808
ip.lpd.enable	1026	memory.ram_free	809
ip.mac_raw	1027	memory.ram_size	810
ip.mirror.appl_path	1028	netmanage.avalanche.available_port	813
ip.mirror.auto	1029	netmanage.avalanche.startup_update	819
ip.mirror.error_retry	1030	netmanage.avalanche.agent_addr	811
ip.mirror.feedback.auto	1031	netmanage.avalanche.available_agent	812
ip.mirror.feedback.freq	1032	netmanage.avalanche.encryption_type	814
ip.mirror.feedback.odometer	1033	netmanage.avalanche.interval	815
ip.mirror.feedback.path	1034	netmanage.avalanche.interval_update	816
ip.mirror.fetch	1035	netmanage.avalanche.model_name	817
ip.mirror.freq	1036	netmanage.avalanche.set_property	818
ip.mirror.freq_hours	1037	netmanage.avalanche.tcp_connection_timeout	820
ip.mirror.last_error	1038	netmanage.avalanche.text_msg.beep	821
ip.mirror.last_time	1039	netmanage.avalanche.text_msg.display	822
ip.mirror.mode	1040	netmanage.avalanche.text_msg.print	823
ip.mirror.password	1041	netmanage.avalanche.udp_timeout	824
ip.mirror.path	1042	odometer.headclean	825
ip.mirror.reset_delay	1043	odometer.headnew	826
ip.mirror.server	1044	odometer.label_dot_length	827
ip.mirror.success	1045	odometer.media_marker_count1	828
ip.mirror.success_time	1046	odometer.media_marker_count2	829
ip.mirror.username	1047	odometer.retracts_count	830
ip.mirror.version	1048	odometer.rfid.valid_resettable	832
ip.netmask	1049	odometer.rfid.void_resettable	833
ip.pop3.enable	1050	odometer.total_print_length	831

parallel_port.mode	834	wlan.11n.aggregation	1093
parallel_port.present	835	wlan.11n.greenfield	1094
power.dtr_power_off	836	wlan.11n.rifs	1095
print.tone	837	wlan.11n.short_gi_20mhz	1097
rfid.adaptive_antenna	838	wlan.11n.short_gi_40mhz	1096
rfid.antenna_sweep	839	wlan.8021x.validate_peap_server_certificate	1098
rfid.country_code	840	wlan.active_channels	1099
rfid.enable	841	wlan.adhocautomode	1101
rfid.error.response	842	wlan.adhocchannel	1102
rfid.hop_table_version	843	wlan.allowed_band	1100
rfid.position.program	844	wlan.associated	1103
rfid.reader_1.antenna_port	845	wlan.auth_type	1104
rfid.reader_1.firmware_version	850	wlan.bssid	1105
rfid.reader_1.hardware_version	851	wlan.channel	1106
rfid.reader_1.model	852	wlan.channel_mask	1107
rfid.reader_1.power.read	847	wlan.country_code	1108
rfid.reader_1.power.single_power	849	wlan.current_tx_rate	1109
rfid.reader_1.power.write	848	wlan.encryption_index	1110
rfid.region_code	853	wlan.encryption_key[1 2 3 4]1	1111
rfid.tag.calibrate	854	wlan.encryption_mode	1112
rfid.tag.data	855	wlan.essid	1113
rfid.tag.read.content	856	wlan.firmware_version	1114
rfid.tag.read.execute	857	wlan.ip.addr	1115
rfid.tag.read.result_line1	858	wlan.ip.arp_interval	1116
rfid.tag.read.result_line1_alternate	860	wlan.ip.default_addr_enable	1117
rfid.tag.read.result_line2	859	wlan.ip.dhcp.cache_ip	1118
rfid.tag.read.result_line2_alternate	861	wlan.ip.dhcp.cid_all	1119
rfid.tag.test	862	wlan.ip.dhcp.cid_enable	1120
rfid.tag.test.content	863	wlan.ip.dhcp.cid_prefix	1121
rfid.tag.test.execute	864	wlan.ip.dhcp.cid_suffix	1122
rfid.tag.test.result_line1	865	wlan.ip.dhcp.cid_type	1123
rfid.tag.test.result_line2	866	wlan.ip.dhcp.lease.last_attempt	1124
rfid.tag.type	867	wlan.ip.dhcp.lease.length	1125
sensor.cover_open	870	wlan.ip.dhcp.lease.server	1126
usb.device.device_id_string	871	wlan.ip.dhcp.lease.time_left	1127
usb.device.device_unique_id	872	wlan.ip.dhcp.option12	1128
usb.device.device_version	873	wlan.ip.dhcp.option12_format	1129
usb.device.manufacturer_string	874	wlan.ip.dhcp.option12_value	1130
usb.device.product_id	875	wlan.ip.dhcp.request_timeout	1131
usb.device.product_string	876	wlan.ip.dhcp.requests_per_session	1132
usb.device.serial_string	877	wlan.ip.dhcp.session_interval	1133
usb.device.vendor_id	878	wlan.ip.dns.servers	1134
usb.halt	879	wlan.ip.gateway	1135
weblink.enable	1070	wlan.ip.netmask	1136
weblink.ip.conn[1 2].authentication.add	1071	wlan.ip.port	1137
weblink.ip.conn[1 2].authentication.entries	1073	wlan.ip.port_alternate	1138
weblink.ip.conn[1 2].authentication.remove	1074	wlan.ip.port_json_config	1139
weblink.ip.conn[1 2].location	1075	wlan.ip.protocol	1140
weblink.ip.conn[1 2].maximum_simultaneous_		wlan.ip.timeout.enable	1141
connections	1076	wlan.ip.timeout.value	1142
weblink.ip.conn[1 2].num_connections	1077	wlan.keep_alive.enable	1143
weblink.ip.conn[1 2].proxy	1078	wlan.keep_alive.timeout	1144
weblink.ip.conn[1 2].retry_interval	1080	wlan.kerberos.kdc	1145
weblink.ip.conn[1 2].test.location	1081	wlan.kerberos.mode	1146
weblink.ip.conn[1 2].test.retry_interval	1083	wlan.kerberos.password	1147
weblink.ip.conn[1 2].test.test_on	1084	wlan.kerberos.realm	1148
weblink.logging.clear	1086	wlan.kerberos.realm	1149
weblink.logging.entries	1087	wlan.leap_mode	1150
weblink.logging.max_entries	1088	wlan.leap_password	1151
weblink.printer_reset_required	1090	wlan.leap_username	1152
weblink.restore_defaults	1091	wlan.mac_addr	1153
wlan.11n.20mhz_only	1092	wlan.mac_raw	1154

wlan.operating_mode	1155
wlan.password	1156
wlan.permitted_channels	1157
wlan.preamble	1158
wlan.private_key_password	1159
wlan.region_code	1160
wlan.roam.interchannel_delay	1161
wlan.roam.interval	1162
wlan.roam.max_chan_scan_time	1163
wlan.roam.max_fail	1164
wlan.roam.rssi	1165
wlan.roam.signal	1166
wlan.security	1167
wlan.signal_noise	1174
wlan.signal_quality	1175
wlan.signal_strength	1176
wlan.station_name	1177
wlan.tx_power	1178
wlan.tx_rate	1179
wlan.user_channel_list	1180
wlan.username	1181
wlan.waveagent.enable	1182
wlan.waveagent.udp_port	1183
wlan.wep.auth_type	1184
wlan.wep.index	1185
wlan.wep.key_format	1191
wlan.wep.key1	1186
wlan.wep.key2	1187
wlan.wep.key3	1188
wlan.wep.key4	1189
wlan.wpa.psk	1190
zbi.control.add_breakpoint	880
zbi.control.break	881
zbi.control.clear_breakpoints	882
zbi.control.delete_breakpoint	883
zbi.control.line_number	884
zbi.control.restart	885
zbi.control.run	886
zbi.control.step	887
zbi.control.terminate	888
zbi.control.variable_name	889
zbi.control.variable_value	890
zbi.key	891
zbi.last_error	892
zbi.reseller_key	893
zbi.revision	894
zbi.running_program_name	895
zbi.start_info.execute	896
zbi.start_info.file_name	897
zbi.start_info.memory_alloc	898
zbi.state	899
zpl.caret	900
zpl.control_character	901
zpl.delimiter	902
zpl.label_length	903
zpl.left_position	904
zpl.system_error	905
zpl.system_status	907
zpl.zpl_mode	909
zpl.zpl_override	910



Notes • _____

About This Document

This section provides an overview of the entire document, contact information, and details on document structure and organization.

Contents

Introduction	42
Who Should Use This Document.	42
How This Document Is Organized	43
Contacts	44
Document Conventions	45

Introduction

This guide is the unabridged, alphabetical reference of programming commands supported in the firmware. This includes all ZPL commands and SGD commands.



Important • These are important points to note when using ZPL and SGD commands:

- ZPL and SGD commands should be sent to the printer as separate files.
- Certain settings can be controlled by both ZPL and SGD. Configuration changes made in ZPL can affect configuration changes made in SGD.

Firmware You can get the printer's firmware version by printing out a configuration label. For instructions to do so, see your printer's user guide.



Note • For firmware upgrades go to: www.zebra.com.



Important • These are important points to note when using a Zebra G-Series printer:

- You can send instructions to the printer using multiple programming languages: EPL, ZPL, or SGD. EPL and ZPL commands configure the printer, print labels, and get device status information. SGD commands set and get configuration details. These three languages can be used without the need to send the printer instructions to switch from one language to another.
- EPL, ZPL, and SGD commands must be sent to the printer as separate files. They cannot be used together in one format, or set of commands. For example, if you send a series of SGD commands to the printer and they are followed by a printable format, this needs to be done using separate files.

Many text editors and word processors can recreate most examples in this guide in ASCII format. However, for other encodings such as Unicode, a text editor such as Microsoft Notepad is needed.

If there are any terms used in this guide that you need clarification on, please see the [Glossary on page 1379](#).

Who Should Use This Document

This Programming Guide is for programmers who are familiar working with programming languages.

How This Document Is Organized

The Programming Guide is set up as follows:

Section	Description
<i>About This Document</i>	Provides a high-level overview about this guide and Zebra Programming Language (ZPL).
<i>ZPL Commands</i>	Provides an alphabetical, detailed description of each ZPL command.
<i>ZPL RFID Commands</i>	Provides an alphabetical, detailed description of each ZPL RFID command, and some examples of how to use them.
<i>ZPL Wireless Commands</i>	Provides new and modified ZPL commands for the wireless print server.
<i>ZBI Commands</i>	Provides details about the Zebra Basic Interpreter, its commands, descriptions, formats, and parameters.
<i>SGD Printer Commands</i>	Provides a high-level overview of printer setting Set / Get / Do (SGD) commands.
<i>SGD Wired Commands</i>	Provides a high-level overview of the wired Set / Get / Do (SGD) commands.
<i>SGD Wireless Commands</i>	Provides a high-level overview of the wireless Set / Get / Do (SGD) commands.
Appendixes	<p>The appendixes include:</p> <ul style="list-style-type: none"> <i>Zebra Code Pages</i> <i>ASCII</i> <i>Fonts and Bar Codes</i> <i>Mod 10 and Mod 43 Check Digits</i> <i>Error Detection Protocol</i> <i>ZB64 Encoding and Compression</i> <i>Field Interactions</i> <i>Real Time Clock</i> <i>ZBI Character Set</i> <i>SGD Command Support</i> <i>Firmware Features</i> <i>Mirror</i> <i>Wireless Markup Language (WML)</i> <i>Using Weblink</i> <i>HTTP POST Alerts</i>
<i>Glossary</i>	Glossary of terms.

Contacts

Technical Support via the Internet is available 24 hours per day, 365 days per year.

Web Site: www.zebra.com

E-mail Back Technical Library:

E-mail address: emb@zebra.com

Subject line: Emaillist

Self Service Knowledge Base: www.zebra.com/knowledgebase

Online Case Registration: www.zebra.com/techrequest

Which Department Do You Need?	The Americas	Europe, Middle East, and Africa	Asia Pacific and India
Regional Headquarters	Zebra Technologies Corporation 475 Half Day Road, Suite 500 Lincolnshire, IL 60069 USA T: +1 847 634 6700 Toll-free +1 866 230 9494 F: +1 847 913 8766	Zebra Technologies Europe Limited Dukes Meadow Millboard Road Bourne End Buckinghamshire, SL8 5XF United Kingdom T: +44 (0) 1628 556000 F: +44 (0) 1628 556001	Zebra Technologies Asia Pacific Pte. Ltd. 120 Robinson Road #06-01 Parakou Building Singapore 068913 T: +65 6858 0722 F: +65 6885 0838
Technical Support For questions on the operation of Zebra equipment and software, please call your distributor. For additional assistance, contact us. <i>Please have your model and serial numbers available.</i>	T: +1 877 ASK ZEBRA (275 9327) F: +1 847 913 2578 Hardware: ts1@zebra.com Software: ts3@zebra.com <i>Kiosk printers:</i> T: +1 866 322 5202 E: kiosksupport@zebra.com	T: +44 (0) 1628 556039 F: +44 (0) 1628 556003 E: Tseurope@zebra.com	T: +65 6858 0722 F: +65 6885 0838 E: China: tschina@zebra.com <i>All other areas:</i> tsasiapacific@zebra.com
Repair Service Department For back-to-base service and repair.	T: +1 877 ASK ZEBRA (275 9327) F: +1 847 821 1797 E: repair@zebra.com To request a repair in the U.S., go to www.zebra.com/repair .	T: +44 (0) 1772 693069 F: +44 (0) 1772 693046 New requests: ukrma@zebra.com Status updates: repairupdate@zebra.com	T: +65 6858 0722 F: +65 6885 0838 E: China: tschina@zebra.com <i>All other areas:</i> tsasiapacific@zebra.com
Technical Training Department For Zebra product training courses.	T: +1 847 793 6868 T: +1 847 793 6864 F: +1 847 913 2578 E: ttamerica@zebra.com	T: +44 (0) 1628 556000 F: +44 (0) 1628 556001 E: Eurtraining@zebra.com	T: +65 6858 0722 F: +65 6885 0838 E: China: tschina@zebra.com <i>All other areas:</i> tsasiapacific@zebra.com
Inquiry Department For product literature and distributor and dealer information.	T: +1 877 ASK ZEBRA (275 9327) E: inquiry4@zebra.com	T: +44 (0) 1628 556037 F: +44 (0) 1628 556005 E: mseurope@zebra.com	E: China: GCmarketing@zebra.com <i>All other areas:</i> APACChannelmarketing@zebra.com
Customer Service Department (US) Internal Sales Department (UK) For printers, parts, media, and ribbon, please call your distributor or contact us.	T: +1 877 ASK ZEBRA (275 9327) E: clientcare@zebra.com	T: +44 (0) 1628 556032 F: +44 (0) 1628 556001 E: cseurope@zebra.com	T: +65 6858 0722 F: +65 6885 0836 E: China: order-csr@zebra.com <i>All other areas:</i> csasiapacific@zebra.com

Key: T: Telephone
F: Facsimile
E: E-mail

Document Conventions

The following conventions are used throughout this document to convey certain information.

Alternate Color (online only) Cross-references contain hot links to other sections in this guide. If you are viewing this guide online in.pdf format, you can click the cross-reference ([blue text](#)) to jump directly to its location.

Command Line Examples Command line examples appear in `Consolas` font. For example, type `ZTools` to get to the Post-Install scripts in the `/bin` directory.

Files and Directories File names and directories appear in `Courier New` font. For example, the `Zebra<version number>.tar` file and the `/root` directory.

Icons Used



Important • Advises you of information that is essential to complete a task.



Note • Indicates neutral or positive information that emphasizes or supplements important points of the main text.

Callouts are used when an illustration contains information that needs to be labeled and described. A table that contains the labels and descriptions follows the graphic. [Figure 1](#) provides an example.

Figure 1 • Sample Figure with Callouts

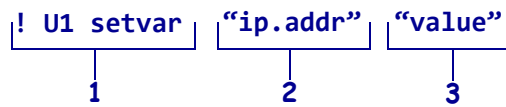

1	Command—always preceded with an exclamation point (!). A space resides between the ! and U1 and between U1 and the command (setvar or getvar).
2	Attribute—always in double quotes.
3	Chosen value—always in double quotes. Only applicable for setvar .



Notes • _____

ZPL Commands

This section contains the complete alphabetical listing of ZPL II commands.

Description This heading provides an explanation of how the command is used, what it is capable of, and any defining characteristics it has.

Format Format explains how the command is syntactically arranged and what parameters it contains. For example, the `^B8` command prints a EAN-8 bar code. The format of the `^B8` command is: `^B8o,h,f,g`. It is arranged with the caret symbol (^), the command code (B8), and the parameters and are replaced with supported values.

Parameters If a command has values that can be defined to make its function more specific, these are outlined as parameters. Parameters typically have *Accepted Values* and *Default Values*.

Still using the `^B8` example, the `h` parameter is defined as:

`h` = bar code height (in dots)

Accepted Values: 1 to 32000

Default Value: value set by `^BY`

If the command has no parameters – for example `~JA` (Cancel All) – the parameter heading is removed, indicating that the format of the command (`~JA`) is acceptable ZPL II code.



Example • When the command is best clarified in context, an example of the ZPL II code is provided. Text indicating exact code entered is printed in an easily recognizable Courier font. An example of code using the `^B8` command looks like this:

```
^XA
^F050,50
^B8N,100,Y,N
^FD1234567^FS
^XZ
```

Notice that the `^B8` parameter letters have been replaced with real values that apply to the command. In this example `N,100,Y,N` have been entered.

Comment This section is reserved for notes that are of value to a programmer, warnings of potential command interactions, or command-specific information that should be taken into consideration.



Example • An example comment is: **This command works only when the printer is idle, or This command is ignored if a value exceeds the parameter limits.**

Comments are also included next to parameters if they apply directly to a particular setting.

Basic ZPL Exercises and Examples

The purpose of these exercises is to introduce basic ZPL commands to novice ZPL users.

Make sure this checklist is complete:

- Load the printer with labels that are big enough to give you ample space to work with.
- Print a configuration label (CANCEL test).
- Look at the configuration label and make sure that the **LEFT POSITION** is set to **000** and **LABEL TOP** is set to **000**.
- Determine the printer's resolution. It is listed on the configuration label. **8/MM = 200 dpi**, **12/MM = 300 dpi** and **24/MM = 600 dpi**.

Tips

These are some tips when using ZPL:

- Use the DOS text editor to write ZPL files.
- Save the file as a **.txt** file and copy it to the printer from DOS command line.

Before you begin

Some things that are important to understand before you begin are:

- 200 dpi means the resolution of the printhead is 200 dots per inch. If you program the printer to draw a line 100 dots long that equals a half inch. 100 dots on a 300 dpi printer prints a line 1/3 inch long.
- The home position that all your coordinates are referencing is at the left-hand trailing edge of the label as the label comes out of the printer. (There are some exceptions to this.)

Exercises

The exercises start simple and gradually progress to give you an opportunity to try a variety of commonly used ZPL commands. Not all commands are covered, but this should be a good core of commands to learn. Some commands may not be supported due to the firmware version in your printer.

Exercise 1 • This exercise shows you how to specify a location for an entered name.

1. Print your name on the label.
2. Start by printing just your name on the label. Use this format as a model:



Important • Your name goes where you see `xxxxxxxxxxxx` in the second line of code.

3. Send this format to the printer:

```

1 → ^XA
2 → ^F050,50^ADN,36,20^FDxxxxxxxxxxxx
3 → ^FS
4 → ^XZ
                    ↑
                    5
    
```

1	Every format starts with the ^XA command
2	^FO (field origin) command
3	^FS (field separator) command
4	Every format ends with the ^XZ command
5	^FD (field data) command

4. When the label prints correctly, alter the first number after the ^FOx. See how that change affects the print position. Alter the second number after the ^FO50, x and see how that the print position.

Font instruction

`^ADN`

1. Alter the numbers after the `^ADN, x, x` command.
 - 18,10 is the smallest size you can make the **D** font.
 - The first number is the height of the font in dots. The second number is the width in dots.
 - You can use direct multiples up to ten times that size as a maximum.



Example • 180,100 is the largest you can make the **D** font.

- 25,18 would not be a valid size. The printer rounds to the next recognizable size.
2. Check the font matrices tables for other fonts to try. See *Fonts and Bar Codes on page 1209*.
 3. Try the zero scalable font `^A0N, x, x`.
This font is scalable, and you can choose any height and width.

Rotation commands

1. Change `^ADN` to `^ADR`, and then `^ADI`, and then `^ADB`.
See how the print position changes.
2. Add more fields.
3. Add two more fields to print directly under your name using the `^ADN, 36, 20` font and size:
Your street address
Your city, state, zip

4. You must add two more lines of code that start off with:

```
^XA  
^F050,50^ADN,36,20^FDxxxxxxxxxxxx^FS  
^FO (fill in the rest)  
^FO (fill in the rest)  
^XZ
```

Make sure all these fields print in the same font and size and left side of fields has same vertical alignment.

```
Your name  
1200 W Main Street  
Anytown, IL 60061
```

Special Effects commands

The Graphic Box or `^GB` command or is used in some of the special effects commands.

Reverse Printing a Field

1. Write the following format and send to the printer:

```
^XA
^PR1
^F0100,100
^GB70,70,70,,3^FS
^F0200,100
^GB70,70,70,,3^FS
^F0300,100
^GB70,70,70,,3^FS
^F0400,100
^GB70,70,70,,3^FS
^F0107,110^CF0,70,93
^FR^FDREVERSE^FS
^XZ
```

2. To see the effects, remove:

```
^FR^FDREVERSE^FS
```

3. To see the effects, try removing one of the `^GB` lines of code.

Label Reverse Print

1. Write the following format and send to the printer:

```
^XA^LRY
^F0100,50
^GB195,203,195^FS
^F0180,110^CFG
^FDLABEL^FS
^F0130,170
^FDREVERSE^FS
^XZ
```

2. To see the effects, remove:

```
^GB195,203,195^FS
```

Mirror Image of Label

1. Write the following format and send to the printer:
^XA^PMY
^F0100,100
^CFG
^FDMIRROR^FS
^F0100,160
^FDIMAGE^FS
^XZ
2. To see the effects, in the first line of code change ^PMY to ^PMN.

Print Orientation

1. Write the following format and send to the printer:
^XA^CFD
^POI
^LH330,10
^F050,50
^FDZEBRA TECHNOLOGIES^FS
^F050,75
^FDVernon Hills, IL^FS
^XZ
2. To see the effects, in the second line of code change ^POI to ^PON.

Exercise 2 • Boxes and lines

1. Use the address format from [Exercise 1](#).
2. Add this new line to your existing format:
^F050,200^GB200,200,2^FS
This prints a box one wide by one inch long and the thickness of the line is 2 dots.
3. Reposition and resize the square so that it goes around the name and address uniformly.
4. Print a line by adding:
^F050,300^GB400,0,4,^FS
This prints a horizontal line two inches wide by 4 dots thick.
5. Print a vertical line using this code:
^F0100,50^GB0,400,4^FS

Exercise 3 • Bar codes — ^B3 code 39 bar code

1. Write the following format and send to the printer:
^XA
^F050,50^B3N,N,100,Y,N^FD123456^FS
^XZ

2. Try changing each of the parameters in the `^B3` string so you can see the effects.

```
^B3o,e,h,f,g
^BY
```



Important • For valid parameter choices, see `^B3` on page 68.

3. Insert the `^BY` command just before the `^B3` to see how the narrow bar width can be altered.

```
^F050,50^BY2^B3..etc ^BYx, acceptable values for x are 1 through 10
```

4. Alter the ratio of the narrow to wide bar.

```
^F050,50^BY2,3^B3..etc ^BY2,x acceptable values for x are 2.1 through 3 in .1 increments
```

5. Print out a `^B3` bar code with the interpretation line on top of the bar code and the bar code rotated 90 degrees.

6. Add a `^PQ` just before the `^XZ` to print several labels.

```
^PQ4
^XZ
^PR Print rate (in inches per second)
```

7. Add a `^PR` command after the `^XA` at the beginning of the format to change the print rate (print speed).

```
^XA
^PR4 then try ^PR6 ^PRx acceptable values for x are 2 through 12
(check printer specs)
```

See how the print speed affects the print quality of the bar code. You may need to increase the printer darkness setting at higher print speeds.

Exercise 4 • `^SN` — Serial Number command

1. Send this format to the printer:

```
^XA
^F0100,100^ADN,36,20^SN001,1,Y^FS
^PQ3
^XZ
```

To vary the `^SNv,n,z` to exercise increment/decrement and leading zeros functions, consult this guide.

If your serial number contains alpha and numeric characters, you can increment or decrement a specific segment of the data even if it is in the middle, as this sample sequence shows:

```
ABCD1000EFGH, ABCD1001EFGH, ABCD1002EFGH
```

2. Send this file to the printer and to see how it increments the serial number. The **^SF** command can also work with alpha characters.

^XA

^F0100,100^ADN,36,20^FDABCD1000EFGH^SF%%d%%,10000^FS

^PQ15

^XZ

Notice how the field data character position aligns with the **^SF** data string:

^	F	D	A	B	C	D	1	0	0	0	E	F	G	H
^	S	F	%	%	%	%	d	d	d	d	%	%	%	%
										1	0	0	0	0
										2	0	0	0	0
										3	0	0	0	0

And on through...

							1	0	1	4	0	0	0	0
--	--	--	--	--	--	--	---	---	---	---	---	---	---	---

The last label prints **ABCD1014EFGH**.

The **%** is placed in positions that you do not want to increment or decrement,
d = decimal, **10000** = increment value.

For more details on **^SF**, see **^SF on page 339**.

Exercise 5 • Saving a template to memory. ^IS and image save and image load.

Note • This exercise helps you troubleshoot your code against the errors you see on your labels.

1. Send this format to the printer:

```
^XA
^F020,30^GB750,1100,4^FS
^F020,30^GB750,200,4^FS
^F020,30^GB750,400,4^FS
^F020,30^GB750,700,4^FS
^F020,226^GB325,204,4^FS
^F030,40^ADN,36,20^FDShip to:^FS
^F030,260^ADN,18,10^FDPart number #^FS
^F0360,260^ADN,18,10^FDDescription:^FS
^F030,750^ADN,36,20^FDFrom:^FS
^ISR:SAMPLE.GRF^FS
^XZ
```

2. Send this format:

```
^XA
^ILR:SAMPLE.GRF^FS
^F0150,125^ADN,36,20^FDAcme Printing^FS
^F060,330^ADN,36,20^FD14042^FS
^F0400,330^ADN,36,20^FDScrew^FS
^F070,480^BY4^B3N,,200^FD12345678^FS
^F0150,800^ADN,36,20^FDMacks Fabricating^FS
^XZ
```

In this way the template only needs to be sent one time to the printer's memory. Subsequent formats can be sent recalling the template and merging variable data into the template. In this exercise, the file was saved in the printers **R:** memory, which is volatile.

Exercise 6 • ^DF and ^XF — Download format and recall format

Similar concept to ^IS and ^IL command. ^IS and ^IL processes faster in the printer than ^DF and ^XF.

This is how the ^DF and ^XF format structure produces a label similar to the ^IS/^IL sample you just tried.

Figure 2 • Download and Recall Format

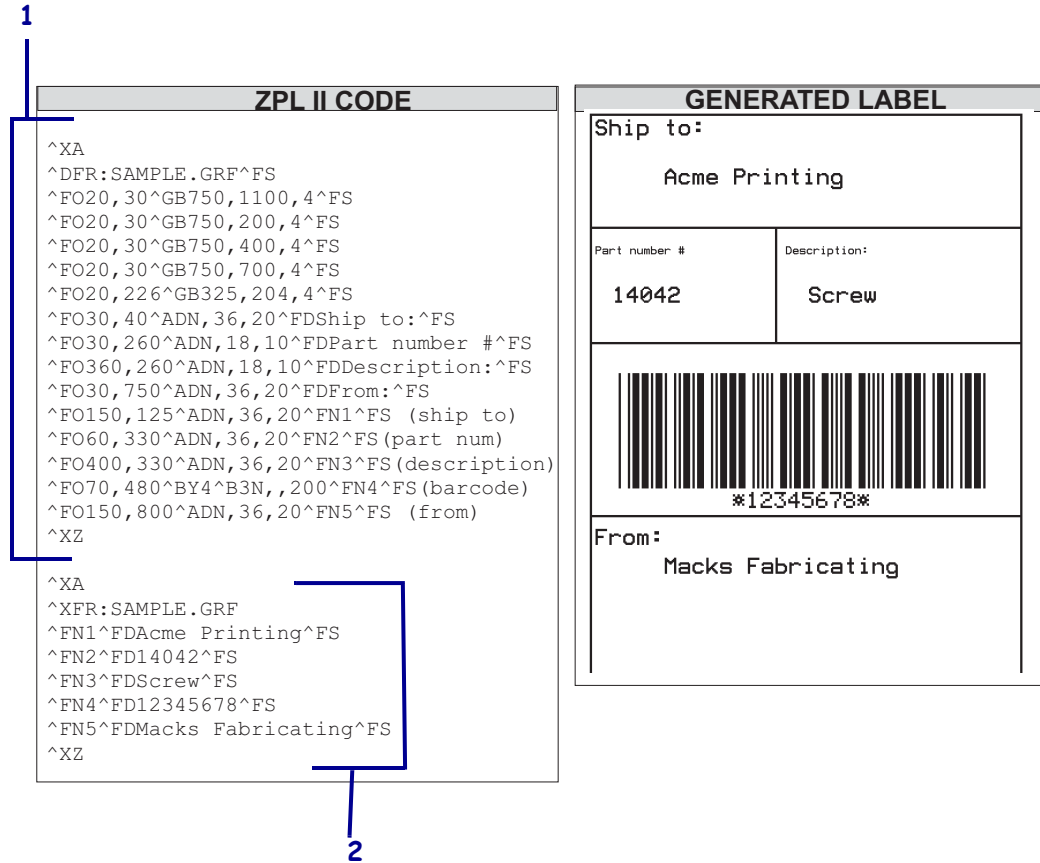

1	Download format code
2	Recall format call that generates the generated label in Figure 2 .

Exercise 7 • Asian and Unicode Encodings

.14↑

This exercise works in printers with firmware version V60.14, V50.14, or later.

In each of the following examples, the format is saved in the corresponding encoding before being sent down to the printer and the ZPL script was made in Microsoft Notepad, a basic text editor. The characters were inserted from the character map in Windows or typed from the keyboard.



Example • This is an example of using an Asian encoding, such as UHANGUL, with ASCII text. Using the **CI26** command tells the printer to recognize any byte less than **7F** as ASCII text and every byte above as the first byte of UHANGUAL encoding:

ZPL II CODE	GENERATED LABEL
<pre> ^XA^CW1, B:ANMDK, TTF ^SEB:UHANGUL, DATA^CI26 ^FO100, 100^A1, 50, 50^FDASCII 한국어^FS ^XZ </pre>	



Example • This is an example of using the Unicode encoding, UTF-8:

ZPL II CODE	GENERATED LABEL
<pre> ^XA^CW1, ANMDJ, TTF^CI28 ^FO100, 50^A1, 30, 30^FDENGLISH/日本語/한국어/简体中文/繁体中文^FS ^XZ </pre>	

^A – Scalable/Bitmapped Font

Description The ^A command specifies the font to use in a text field. ^A designates the font for the current ^FD statement or field. The font specified by ^A is used only once for that ^FD entry. If a value for ^A is not specified again, the default ^CF font is used for the next ^FD entry.

Format ^Afo,h,w



Important • Parameter **f** is required. If **f** is omitted it defaults to the last value of the ^CF command.

This table identifies the parameters for this format:

Command	Details
f = font name	<p><i>Accepted Values:</i> A through Z, and 0 to 9</p> <p>Any font in the printer (downloaded, EPROM, stored fonts, fonts A through Z and 0 to 9).</p>
o = field orientation	<p><i>Accepted Values:</i></p> <ul style="list-style-type: none"> N = normal R = rotated 90 degrees (clockwise) I = inverted 180 degrees B = read from bottom up, 270 degrees <p><i>Default Value:</i> the last accepted ^FW value or the ^FW default</p>
h = Character Height (in dots)	<p>Scalable</p> <p><i>Accepted Values:</i> 10 to 32000</p> <p><i>Default Value:</i> last accepted ^CF</p> <p>Bitmapped</p> <p><i>Accepted Values:</i> multiples of height from 1 to 10 times the standard height, in increments of 1</p> <p><i>Default Value:</i> last accepted ^CF</p>
w = width (in dots)	<p>Scalable</p> <p><i>Accepted Values:</i> 10 to 32000</p> <p><i>Default Value:</i> last accepted ^CF</p> <p>Bitmapped</p> <p><i>Accepted Values:</i> multiples of width from 1 to 10 times the standard width, in increments of 1</p> <p><i>Default Value:</i> last accepted ^CF</p>

Scalable Font Command

➔ **Example** • This is an example of a scalable font command:

ZPL II Code

```

^XA
^F050,50
^A0,32,25
^FDZEBRA^FS
^F050,150
^A0,32,25
^FDPROGRAMMING^FS
^F050,250
^A0,32,25^FDLANGUAGE^FS
^XZ

```

Generated Label

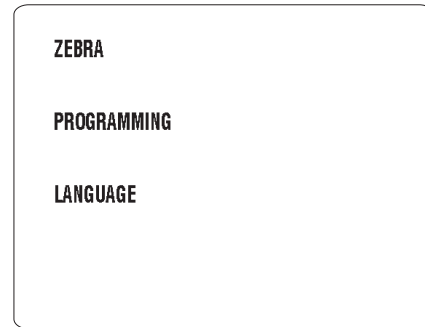

Bitmap Font Command

➔ **Example** • This is an example of a bitmap font command:

ZPL II Code

```

^XA
^F050,50
^ADN,36,20
^FDZEBRA^FS
^F050,150
^ADN,36,20
^FDPROGRAMMING^FS
^F050,250
^ADN,36,20^FDLANGUAGE^FS
^XZ

```

Generated Label

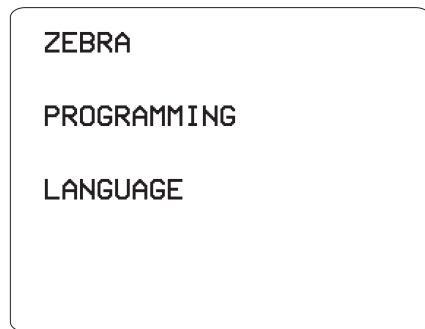

For reference, see [Standard Printer Fonts](#) on page 1210, [Zebra Code Page 850 — Latin Character Set](#) on page 1194, [Fonts and Bar Codes](#) on page 1209, and [ASCII](#) on page 1207.

Comments Fonts are built using a matrix that defines standard height-to-width ratios. If you specify only the height or width value, the standard matrix for that font automatically determines the other value. If the value is not given or a 0 (zero) is entered, the height or width is determined by the standard font matrix.



This command interacts with the justification parameters of `^FO` and `^FT` and with the field direction parameter of `^FP`. For output and examples, see [Field Interactions](#) on page 1243.

^A@ – Use Font Name to Call Font

Description The ^A@ command uses the complete name of a font, rather than the character designation used in ^A. Once a value for ^A@ is defined, it represents that font until a new font name is specified by ^A@.

Format ^A@o,h,w,d:o.x

This table identifies the parameters for this format:

Parameters	Details
o = field orientation	<p><i>Accepted Values:</i></p> <ul style="list-style-type: none"> N = normal R = rotates 90 degrees (clockwise) I = inverted 180 degrees B = read from bottom up, 270 degrees <p><i>Default Value:</i> N or the last ^FW value</p>
h = character height (in dots)	<p><i>Default Value:</i> specifies magnification by w (character width) or the last accepted ^CF value. Uses the base height if none is specified.</p> <p>Scalable The value is the height in dots of the entire character block. Magnification factors are unnecessary, because characters are scaled.</p> <p>Bitmapped The value is rounded to the nearest integer multiple of the font's base height, then divided by the font's base height to give a magnification nearest limit.</p>
w = width (in dots)	<p><i>Default Value:</i> specifies magnification by h (height) or the last accepted ^CF value. Specifies the base width is used if none is specified.</p> <p>Scalable The value is the width in dots of the entire character block. Magnification factors are unnecessary, because characters are scaled.</p> <p>Bitmapped The value rounds to the nearest integer multiple of the font's base width, then divided by the font's base width to give a magnification nearest limit.</p>
d = drive location of font	<p><i>Accepted Values:</i> R:, E:, B:, and A:</p> <p><i>Default Value:</i> R:</p>
o = font name	<p><i>Accepted Values:</i> any valid font</p> <p><i>Default Value:</i> if an invalid or no name is entered, the default set by ^CF is used. If no font has been specified in ^CF, font A is used.</p> <p>The font named carries over on all subsequent ^A@ commands without a font name.</p>
x = extension	<p><i>Accepted Values:</i></p> <ul style="list-style-type: none"> .FNT = font .TTF = TrueType Font .TTE = TrueType Extension



.TTE is only supported in firmware version V60.14.x, V50.14.x, or later.

→ **Example** • This example is followed by a table that identifies the called out lines of code:

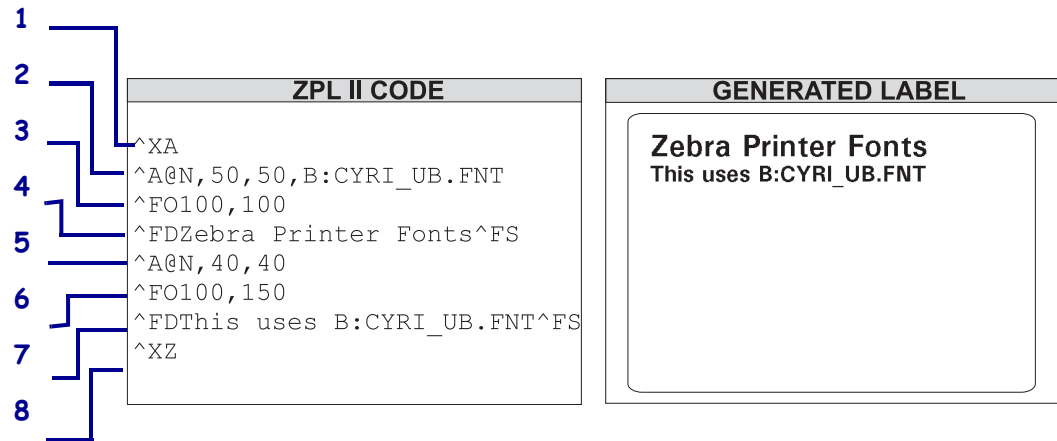

1	Starts the label format.
2	Searches non-volatile printer memory (B:) for CYRI_UB.FNT. When the font is found, the ^A@ command sets the print orientation to normal and the character size to 50 dots by 50 dots.
3	Sets the field origin at 100,100.
4	Prints the field data, <i>Zebra Printer Fonts</i> on the label.
5	Calls the font again and character size is decreased to 40 dots by 40 dots.
6	Sets the new field origin at 100,150.
7	Prints the field data, <i>This uses the B:CYRI_UB.FNT</i> on the label.
8	Ends the label format.

For reference, see [Zebra Code Page 850 — Latin Character Set](#) on page 1194, [Fonts and Bar Codes](#) on page 1209, and [ASCII](#) on page 1207.

^B0 – Aztec Bar Code Parameters

Description The ^B0 command creates a two-dimensional matrix symbology made up of square modules arranged around a bulls-eye pattern at the center.



Note • The Aztec bar code works with firmware version V60.13.0.11A and V50.13.2 or later.

Format ^B0a,b,c,d,e,f,g

Parameters	Details
a = orientation	<p><i>Accepted Values:</i></p> <ul style="list-style-type: none"> N = normal R = rotated I = inverted 180 degrees B = read from bottom up, 270 degrees <p><i>Default Value:</i> current ^FW value</p>
b = magnification factor	<p><i>Accepted Values:</i> 1 to 10</p> <p><i>Default Value:</i></p> <ul style="list-style-type: none"> 1 on 150 dpi printers 2 on 200 dpi printers 3 on 300 dpi printers 6 on 600 dpi printers
c = extended channel interpretation code indicator	<p><i>Accepted Values:</i></p> <ul style="list-style-type: none"> Y = if data contains ECICs N = if data does not contain ECICs <p><i>Default Value:</i> N</p>
d = error control and symbol size/type indicator	<p><i>Accepted Values:</i></p> <ul style="list-style-type: none"> 0 = default error correction level 01 to 99 = error correction percentage (minimum) 101 to 104 = 1 to 4-layer compact symbol 201 to 232 = 1 to 32-layer full-range symbol 300 = a simple Aztec “Rune” <p><i>Default Value:</i> 0</p>
e = menu symbol indicator	<p><i>Accepted Values:</i></p> <ul style="list-style-type: none"> Y = if this symbol is to be a menu (bar code reader initialization) symbol N = if it is not a menu symbol <p><i>Default Value:</i> N</p>
f = number of symbols for structured append	<p><i>Accepted Values:</i> 1 through 26</p> <p><i>Default Value:</i> 1</p>
g = optional ID field for structured append	<p>The ID field is a text string with 24-character maximum</p> <p><i>Default Value:</i> no ID</p>



Example • This is an example of the **^B0** command:

ZPL II CODE	GENERATED LABEL
<pre data-bbox="428 321 894 577">^XA ^B0R,7,N,0,N,1,0 ^FD 7. This is testing label 7^FS ^XZ</pre>	

^B1 – Code 11 Bar Code

Description The ^B1 command produces the Code 11 bar code, also known as USD-8 code. In a Code 11 bar code, each character is composed of three bars and two spaces, and the character set includes 10 digits and the hyphen (-).

- ^B1 supports print ratios of 2.0:1 to 3.0:1.
- Field data (^FD) is limited to the width (or length, if rotated) of the label.

Format ^B1o,e,h,f,g



Important • If additional information about the Code 11 bar code is required, go to www.aimglobal.org.

Parameters	Details
o = orientation	<p><i>Accepted Values:</i></p> <ul style="list-style-type: none"> N = normal R = rotated 90 degrees (clockwise) I = inverted 180 degrees B = read from bottom up, 270 degrees <p><i>Default Value: current ^FW value</i></p>
e = check digit	<p><i>Accepted Values:</i></p> <ul style="list-style-type: none"> Y = 1 digit N = 2 digits <p><i>Default Value: N</i></p>
h = bar code height (in dots)	<p><i>Accepted Values: 1 to 32000</i></p> <p><i>Default Value: value set by ^BY</i></p>
f = print interpretation line	<p><i>Accepted Values:</i></p> <ul style="list-style-type: none"> Y = yes N = no <p><i>Default Value: Y</i></p>
g = print interpretation line above code	<p><i>Accepted Values:</i></p> <ul style="list-style-type: none"> Y = yes N = no <p><i>Default Value: N</i></p>



Example • This is an example of the Code 11 bar code:

ZPL II CODE	CODE 11 BAR CODE
<pre> ^XA ^FO100,100^BY3 ^B1N,N,150,Y,N ^FD123456^FS ^XZ </pre>	 <p>△12345611△</p>

CODE 11 BAR CODE CHARACTERS										
0	1	2	3	4	5	6	7	8	9	-
Internal Start/Stop Character:△										
<i>When used as a stop character:</i>										
△ is used with 1 check digit										
△ is used with 2 check digits										

^B2 – Interleaved 2 of 5 Bar Code

Description The ^B2 command produces the Interleaved 2 of 5 bar code, a high-density, self-checking, continuous, numeric symbology.

Each data character for the Interleaved 2 of 5 bar code is composed of five elements: five bars or five spaces. Of the five elements, two are wide and three are narrow. The bar code is formed by interleaving characters formed with all spaces into characters formed with all bars.

- ^B2 supports print ratios of 2.0:1 to 3.0:1.
- Field data (^FD) is limited to the width (or length, if rotated) of the label.

Format ^B2o,h,f,g,e,j



Important • If additional information about the Interleaved 2 of 5 bar code is required, go to www.aimglobal.org.

Parameters	Details
o = orientation	<p><i>Accepted Values:</i></p> <p>N = normal R = rotated 90 degrees (clockwise) I = inverted 180 degrees B = read from bottom up, 270 degrees</p> <p><i>Default Value:</i> current ^FW value</p>
h = bar code height (in dots)	<p><i>Accepted Values:</i> 1 to 32000</p> <p><i>Default Value:</i> value set by ^BY</p>
f = print interpretation line	<p><i>Accepted Values:</i></p> <p>Y = yes N = no</p> <p><i>Default Value:</i> Y</p>
g = print interpretation line above code	<p><i>Accepted Values:</i></p> <p>Y = yes N = no</p> <p><i>Default Value:</i> N</p>
e = calculate and print Mod 10 check digit	<p><i>Accepted Values:</i></p> <p>Y = yes N = no</p> <p><i>Default Value:</i> N</p>



Example • This is an example of an Interleaved 2 of 5 bar code:

ZPL II CODE	INTERLEAVED 2 OF 5 BAR CODE								
<pre> ^XA ^FO100,100^BY3 ^B2N,150,Y,N,N ^FD123456^FS ^XZ </pre>	 123456								
INTERLEAVED 2 OF 5 BAR CODE CHARACTERS									
0	1	2	3	4	5	6	7	8	9
Start/Stop (internal)									

Comments The total number of digits in an Interleaved 2 of 5 bar code must be even. The printer automatically adds a leading 0 (zero) if an odd number of digits is received.

The Interleaved 2 of 5 bar code uses the Mod 10 check-digit scheme for error checking. For more information on Mod 10 check digits, see [Mod 10 Check Digit on page 1224](#).

^B3 – Code 39 Bar Code

Description The Code 39 bar code is the standard for many industries, including the U.S. Department of Defense. It is one of three symbologies identified in the American National Standards Institute (ANSI) standard MH10.8M-1983. Code 39 is also known as USD-3 Code and 3 of 9 Code.

Each character in a Code 39 bar code is composed of nine elements: five bars, four spaces, and an inter-character gap. Three of the nine elements are wide; the six remaining elements are narrow.

- ^B3 supports print ratios of 2.0:1 to 3.0:1.
- Field data (^FD) is limited to the width (or length, if rotated) of the label.
- Code 39 automatically generates the start and stop character (*).
- Asterisk (*) for start and stop character prints in the interpretation line, if the interpretation line is turned on.
- Code 39 is capable of encoding the full 128-character ASCII set.

Format ^B3o,e,h,f,g



Important • If additional information about the Code 39 bar code is required, go to www.aimglobal.org.

Parameters	Details
o = orientation	<p><i>Accepted Values:</i></p> <p>N = normal R = rotated 90 degrees (clockwise) I = inverted 180 degrees B = read from bottom up, 270 degrees</p> <p><i>Default Value:</i> current ^FW value</p>
e = Mod-43 check digit	<p><i>Accepted Values:</i></p> <p>Y = yes N = no</p> <p><i>Default Value:</i> N</p>
h = bar code height (in dots)	<p><i>Accepted Values:</i> 1 to 32000</p> <p><i>Default Value:</i> value set by ^BY</p>
f = print interpretation line	<p><i>Accepted Values:</i></p> <p>Y = yes N = no</p> <p><i>Default Value:</i> Y</p>
g = print interpretation line above code	<p><i>Accepted Values:</i></p> <p>Y = yes N = no</p> <p><i>Default Value:</i> N</p>



Example 1 • This is an example of a Code 39 bar code:

ZPL II CODE	CODE 39 BAR CODE																																												
<pre> ^XA ^FO100,100^BY3 ^B3N,N,100,Y,N ^FD123ABC^FS ^XZ </pre>	 <p style="text-align: center;">*123ABC*</p>																																												
CODE 39 BAR CODE CHARACTERS																																													
<table style="width: 100%; border: none;"> <tr> <td style="width: 10%;"></td> <td style="width: 10%;">0</td> <td style="width: 10%;">1</td> <td style="width: 10%;">2</td> <td style="width: 10%;">3</td> <td style="width: 10%;">4</td> <td style="width: 10%;">5</td> <td style="width: 10%;">6</td> <td style="width: 10%;">7</td> <td style="width: 10%;">8</td> <td style="width: 10%;">9</td> </tr> <tr> <td>A</td><td>B</td><td>C</td><td>D</td><td>E</td><td>F</td><td>G</td><td>H</td><td>I</td><td>J</td><td>K</td> </tr> <tr> <td>L</td><td>M</td><td>N</td><td>O</td><td>P</td><td>Q</td><td>R</td><td>S</td><td>T</td><td>U</td><td>V</td> </tr> <tr> <td>W</td><td>X</td><td>Y</td><td>Z</td><td>-</td><td>.</td><td>\$</td><td>/</td><td>+</td><td>%</td><td>Space</td> </tr> </table>			0	1	2	3	4	5	6	7	8	9	A	B	C	D	E	F	G	H	I	J	K	L	M	N	O	P	Q	R	S	T	U	V	W	X	Y	Z	-	.	\$	/	+	%	Space
	0	1	2	3	4	5	6	7	8	9																																			
A	B	C	D	E	F	G	H	I	J	K																																			
L	M	N	O	P	Q	R	S	T	U	V																																			
W	X	Y	Z	-	.	\$	/	+	%	Space																																			

Comments Extended ASCII is a function of the scanner, not of the bar code. Your scanner must have extended ASCII enabled for this feature to work. To enable extended ASCII in the Code 39, you must first encode +\$ in your ^FD statement. To disable extended ASCII, you must encode -\$ in your ^FD statement.



Example 2 • This example encodes a carriage return with line feed into a Code 39 bar code:

ZPL II CODE	GENERATED LABELS
<pre> ^XA ^FO20,20 ^B3N,N,100,Y ^FDTEST+\$\$M\$J-\$^FS ^XZ </pre>	 <p style="text-align: center;">*TEST+\$\$M\$J-\$*</p>

Full ASCII Mode for Code 39

Code 39 can generate the full 128-character ASCII set using paired characters as shown in these tables:

Table 1 •

ASCII	Code 39	ASCII	Code 39
SOH	\$A	SP	Space
STX	\$B	!	/A
ETX	\$C	"	/B
EOT	\$D	#	/C
ENQ	\$E	\$	/D
ACK	\$F	%	/E
BEL	\$G	&	/F
BS	\$H	'	/G
HT	\$I	(/H
LF	\$J)	/I
VT	\$K	*	/J
FF	\$L	++	/K
CR	\$M	,	/L
SO	\$N	-	-
SI	\$O	.	.
DLE	\$P	/	/O
DC1	\$Q	0	0
DC2	\$R	1	1
DC3	\$S	2	2
DC4	\$T	3	3
NAK	\$U	4	4
SYN	\$V	5	5
ETB	\$W	6	6
CAN	\$X	7	7
EM	\$Y	8	8
SUB	\$Z	9	9
ESC	%A	:	/Z
FS	%B	;	%F
FS	%C	<	%G
RS	%D	=	%H
US	%E	>	%I
		?	%J

Table 2 •

ASCII	Code 39	ASCII	Code 39
@	%V	'	%W
A	A	a	+A
B	B	b	+B
C	C	c	+C
D	D	d	+D
E	E	e	+E
F	F	f	+F
G	G	g	+G
H	H	h	+H
I	I	l	+I
J	J	j	+J
K	K	k	+K
L	L	l	+L
M	M	m	+M
N	N	n	+N
O	O	o	+O
P	P	p	+P
Q	Q	q	+Q
R	R	r	+R
S	S	s	+S
T	T	t	+T
U	U	u	+U
V	V	v	+V
W	W	w	+W
X	X	x	+X
Y	Y	y	+Y
Z	Z	z	+Z
[%K	{	%P
\	%L		%Q
]	%M	}	%R
^	%N	~	%S
_	%O	DEL	%T, %X

^B4 – Code 49 Bar Code

Description The ^B4 command creates a multi-row, continuous, variable-length symbology capable of encoding the full 128-character ASCII set. It is ideally suited for applications requiring large amounts of data in a small space.

The code consists of two to eight rows. A row consists of a leading quiet zone, four symbol characters encoding eight code characters, a stop pattern, and a trailing quiet zone. A separator bar with a height of one module separates each row. Each symbol character encodes two characters from a set of Code 49 characters.

- ^B4 has a fixed print ratio.
- Rows can be scanned in any order.

Format ^B4o,h,f,m



Important • For additional information about the Code 49 bar code is required, go to www.aimglobal.org.

Parameters	Details
o = orientation	<p><i>Accepted Values:</i></p> <ul style="list-style-type: none"> N = normal R = rotated 90 degrees (clockwise) I = inverted 180 degrees B = read from bottom up, 270 degrees <p><i>Default Value:</i> current ^FW value</p>
h = height multiplier of individual rows	<p><i>Accepted Values:</i> 1 to height of label</p> <p><i>Default Value:</i> value set by ^BY</p> <p>This number multiplied by the module equals the height of the individual rows in dots. 1 is not a recommended value.</p>
f = print interpretation line	<p><i>Accepted Values:</i></p> <ul style="list-style-type: none"> N = no line printed A = print interpretation line above code B = print interpretation line below code <p><i>Default Value:</i> N</p> <p>When the field data exceeds two rows, expect the interpretation line to extend beyond the right edge of the bar code symbol.</p>

Parameters	Details
m = starting mode	<p><i>Accepted Values:</i></p> <ul style="list-style-type: none"> 0 = Regular Alphanumeric Mode 1 = Multiple Read Alphanumeric 2 = Regular Numeric Mode 3 = Group Alphanumeric Mode 4 = Regular Alphanumeric Shift 1 5 = Regular Alphanumeric Shift 2 A = Automatic Mode. The printer determines the starting mode by analyzing the field data. <p><i>Default Value: A</i></p>

➔ **Example 1** • This is an example of a Code 49 bar code:

ZPL II CODE	CODE 49 BAR CODE
<pre> ^XA ^FO150,100^BY3 ^B4N,20,A,A ^FD12345ABCDE^FS ^XZ </pre>	

Table 3 •

Field Data Set	Unshifted Character Set	Shift 1 Character Set	Shift 2 Character Set
0	0	,	
1	1	ESC	;
2	2	FS	<
3	3	GS	=
4	4	RS	>
5	5	US	?
6	6	!	@
7	7	"	[
8	8	#	\
9	9	&]
A	A	SOH	a
B	B	STX	b
C	C	ETX	c
D	D	EOT	d
E	E	ENQ	e
F	F	ACK	f
G	G	BEL	g
H	H	BS	h
I	I	HT	i
J	J	LF	j
K	K	VT	k
L	L	FF	l
M	M	CR	m
N	N	SO	n
O	O	SI	o
P	P	DLE	p
Q	Q	DC1	q
R	R	DC2	r
S	S	DC3	s
T	T	DC4	t
U	U	NAK	u
V	V	SYN	v
W	W	ETB	w
X	X	CAN	x
Y	Y	EM	y
Z	Z	SUB	z
-	-	(⌘
.	.)	⌘
SPACE	SPACE	Null	DEL
\$	\$	*	{
/	/	,	
++	++	:	}
%	%	reserved	~
< (Shift 1)			
> (Shift 2)			
: (N.A.)			
; (N.A.)			
? (N.A.)			
= (Numeric Shift)			

Code 49 Shift 1 and 2 Character Substitutions

Code 49 Field Data Character Set

The ^FD data sent to the printer when using starting modes 0 to 5 is based on the Code 49 Internal Character Set. This is shown in the first column of the Code 49 table on the previous page. These characters are Code 49 control characters:

: ; < = > ?

Valid field data must be supplied when using modes 0 to 5. Shifted characters are sent as a two-character sequence of a shift character followed by a character in the unshifted character set.



Example 2 • To encode a lowercase **a**, send **a >** (Shift 2) followed by an uppercase **A**. If interpretation line printing is selected, a lowercase *a* prints in the interpretation line. This reflects what the output from the scanner reads. Code 49 uses uppercase alphanumeric characters only.

If an invalid sequence is detected, the Code 49 formatter stops interpreting field data and prints a symbol with the data up to the invalid sequence. These are examples of invalid sequences:

- Terminating numeric mode with any characters other than 0 to 9 or a Numeric Space.
- Starting in Mode 4 (Regular Alphanumeric Shift 1) and the first field data character is not in the Shift 1 set.
- Starting in Mode 5 (Regular Alphanumeric Shift 2) and the first field data character is not in the Shift 2 set.
- Sending Shift 1 followed by a character not in the Shift 1 set.
- Sending Shift 2 followed by a character not in the Shift 2 set.
- Sending two Shift 1 or Shift 2 control characters.

Advantages of Using the Code 49 Automatic Mode

Using the default (Automatic Mode) completely eliminates the need for selecting the starting mode or manually performing character shifts. The Automatic Mode analyzes the incoming ASCII string, determines the proper mode, performs all character shifts, and compacts the data for maximum efficiency.

Numeric Mode is selected or shifted only when five or more continuous digits are found. Numeric packaging provides no space advantage for numeric strings consisting of fewer than eight characters.

^B5 – Planet Code bar code

Description The ^B5 command is supported in all printers as a resident bar code.



Note • Accepted bar code characters are 0 - 9.

Format ^B5o,h,f,g

Parameters	Details
o = orientation code	<p><i>Accepted Values:</i></p> <ul style="list-style-type: none"> N = normal R = rotated I = inverted 180 degrees B = read from bottom up, 270 degrees <p><i>Default Value:</i> current ^FW value</p>
h = bar code height (in dots)	<p><i>Accepted Values:</i> 1 to 9999</p> <p><i>Default Value:</i> value set by ^BY</p>
f = interpretation line	<p><i>Accepted Values:</i></p> <ul style="list-style-type: none"> N = no Y = yes <p><i>Default Value:</i> N</p>
g = determines if the interpretation line is printed above the bar code	<p><i>Accepted Values:</i></p> <ul style="list-style-type: none"> N = no Y = yes <p><i>Default Value:</i> N</p>



Example • This is an example of a Planet Code bar code:

ZPL II CODE	GENERATED LABEL
<pre> ^XA ^FO150,100^BY3 ^B5N,100,Y,N ^FD12345678901^FS ^XZ </pre>	

^B7 – PDF417 Bar Code

Description The ^B7 command produces the PDF417 bar code, a two-dimensional, multirow, continuous, stacked symbology. PDF417 is capable of encoding over 1,000 characters per bar code. It is ideally suited for applications requiring large amounts of information at the time the bar code is read.

The bar code consists of three to 90 stacked rows. Each row consists of start and stop patterns and symbol characters called *code-words*. A code-word consists of four bars and four spaces. A three code-word minimum is required per row.

The PDF417 bar code is also capable of using the structured append option (^FM), which allows you to extend the field data limitations by printing multiple bar codes. For more information on using structured append, see [^FM on page 195](#).

- PDF417 has a fixed print ratio.
- Field data (^FD) is limited to 3K of character data.

Format ^B7o,h,s,c,r,t

Parameters	Details
o = orientation	<p><i>Accepted Values:</i></p> <ul style="list-style-type: none"> N = normal R = rotated 90 degrees (clockwise) I = inverted 180 degrees B = read from bottom up, 270 degrees <p><i>Default Value:</i> current ^FW value</p>
h = bar code height for individual rows (in dots)	<p><i>Accepted Values:</i> 1 to height of label</p> <p><i>Default Value:</i> value set by ^BY</p> <p>This number multiplied by the module equals the height of the individual rows in dots. If this number is not specified, the overall bar code height, divided by the number of rows, equals the height of the individual rows in dots, where the overall bar code height is defined by the ^BY command. 1 is not a recommended value.</p>
s = security level	<p><i>Accepted Values:</i> 1 to 8 (error detection and correction)</p> <p><i>Default Value:</i> 0 (error detection only)</p> <p>This determines the number of error detection and correction code-words to be generated for the symbol. The default level provides only error detection without correction. Increasing the security level adds increasing levels of error correction and increases the symbol size.</p>
c = number of data columns to encode	<p><i>Accepted Values:</i> 1 to 30</p> <p><i>Default Value:</i> 1:2 (row-to-column aspect ratio)</p> <p>You can specify the number of code-word columns giving control over the width of the symbol.</p>

Parameters	Details
r = number of rows to encode	<p><i>Accepted Values: 3 to 90</i></p> <p><i>Default Value: 1:2</i> (row-to-column aspect ratio)</p> <p>You can specify the number of symbol rows giving control over the height of the symbol. For example, with no row or column values entered, 72 code-words would be encoded into a symbol of six columns and 12 rows. Depending on code-words, the aspect ratio is not always exact.</p>
t = truncate right row indicators and stop pattern	<p><i>Accepted Values:</i></p> <ul style="list-style-type: none"> N = no truncation Y = perform truncation <p><i>Default Value: N</i></p>



Example 1 • This is an example of a PDF417 bar code:

ZPL II CODE	PDF417 BAR CODE
<pre> ^XA ^BY2,3 ^FO10,10^B7N,5,5,,83,N ^FDZebra Technologies Corporation strives to be the expert supplier of innovative solutions to speciality demand labeling and ticketing problems of business and government. We will attract and retain the best people who will understand our customer's needs and provide them with systems, hardware, software, consumables and service offering the best value, high quality, and reliable performance, all delivered in a timely manner. ^FS^XZ </pre>	



Example 2 • This is an example of a PDF417 without and with truncation selected:



PDF417 without Truncation being selected



PDF417 with Truncation being selected



Example 3 • This example shows the ^B7 command used with field hex (^FH) characters:

ZPL II CODE	GENERATED LABEL
<pre> ^XA ^FO50,50^BY3,3.0^B7N,8,5,7,21,N ^FH_ ^FD[]>_1E06_1DP12345678_1DQ160 _1D1JUN123456789A2B4C6D8E_1D20LA6-987 _1D21L54321_ZES_1D15KG1155 _1DBSC151208_1D7Q10GT_1E_04^FS ^XZ </pre>	

Comments Noted in this bulleted list:

- If both columns and rows are specified, their product must be less than 928.
- No symbol is printed if the product of columns and rows is greater than 928.
- No symbol is printed if total code-words are greater than the product of columns and rows.
- Serialization is not allowed with this bar code.
- The truncation feature can be used in situations where label damage is not likely. The right row indicators and stop pattern is reduced to a single module bar width. The difference between a non truncated and a truncated bar code is shown in the previous examples.

Special Considerations for ^BY When Using PDF417

When used with ^B7, the parameters for the ^BY command are:

w = module width (in dots)

Accepted Values: 2 to 10

Default Value: 2

r = ratio

Fixed Value: 3 (ratio has no effect on PDF417)

h = height of bars (in dots)

Accepted Values: 1 to 32000

Default Value: 10

PDF417 uses this only when row height is not specified in the ^B7 h parameter.

Special Considerations for ^FD When Using PDF417

The character set sent to the printer with the ^FD command includes the full ASCII set, except for those characters with special meaning to the printer.

See [Zebra Code Page 850 — Latin Character Set on page 1194](#), [^CC ~CC on page 148](#), and [^CT ~CT on page 163](#).

- CR and LF are also valid characters for all ^FD statements. This scheme is used:
 - \& = carriage return/line feed
 - \\ = backslash (\)
- ^CI13 must be selected to print a backslash (\).

^B8 – EAN-8 Bar Code

Description The ^B8 command is the shortened version of the EAN-13 bar code. EAN is an acronym for European Article Numbering. Each character in the EAN-8 bar code is composed of four elements: two bars and two spaces.

- ^B8 supports a fixed ratio.
- Field data (^FD) is limited to exactly seven characters. ZPL II automatically pads or truncates on the left with zeros to achieve the required number of characters.
- When using JAN-8 (Japanese Article Numbering), a specialized application of EAN-8, the first two non-zero digits sent to the printer are always 49.

Format ^B8o,h,f,g



Important • If additional information about the EAN-8 bar code is required, go to www.aimglobal.org.

Parameters	Details
o = orientation	<p><i>Accepted Values:</i></p> <ul style="list-style-type: none"> N = normal R = rotated 90 degrees (clockwise) I = inverted 180 degrees B = read from bottom up, 270 degrees <p><i>Default Value:</i> current ^FW value</p>
h = bar code height (in dots)	<p><i>Accepted Values:</i> 1 to 32000</p> <p><i>Default Value:</i> value set by ^BY</p>
f = print interpretation line	<p><i>Accepted Values:</i></p> <ul style="list-style-type: none"> N = no Y = yes <p><i>Default Value:</i> Y</p>
g = print interpretation line above code	<p><i>Accepted Values:</i></p> <ul style="list-style-type: none"> N = no Y = yes <p><i>Default Value:</i> N</p>



Example • This is an example of an EAN-8 bar code:

ZPL II CODE	EAN-8 BAR CODE								
<pre> ^XA ^FO100,100^BY3 ^B8N,100,Y,N ^FD1234567^FS ^XZ </pre>									
EAN-8 BAR CODE CHARACTERS									
0	1	2	3	4	5	6	7	8	9

^B9 – UPC-E Bar Code

Description The ^B9 command produces a variation of the UPC symbology used for number system 0. It is a shortened version of the UPC-A bar code, where zeros are suppressed, resulting in codes that require less printing space. The 6 dot/mm, 12 dot/mm, and 24 dot/mm printheads produce the UPC and EAN symbologies at 100 percent of their size. However, an 8 dot/mm printhead produces the UPC and EAN symbologies at a magnification factor of 77 percent.

Each character in a UPC-E bar code is composed of four elements: two bars and two spaces. The ^BY command must be used to specify the width of the narrow bar.

- ^B9 supports a fixed ratio.
- Field data (^FD) is limited to exactly 10 characters, requiring a five-digit manufacturer's code and five-digit product code.
- When using the zero-suppressed versions of UPC, you must enter the full 10-character sequence. ZPL II calculates and prints the shortened version.

Format ^B9,h,f,g,e



Important • If additional information about the UPC-E bar code is required, go to www.aimglobal.org.

Parameters	Details
o = orientation	<p><i>Accepted Values:</i></p> <p>N = normal R = rotated 90 degrees (clockwise) I = inverted 180 degrees B = read from bottom up, 270 degrees</p> <p><i>Default Value:</i> current ^FW value</p>
h = bar code height (in dots)	<p><i>Accepted Values:</i> 1 to 32000</p> <p><i>Default Value:</i> value set by ^BY</p>
f = print interpretation line	<p><i>Accepted Values:</i></p> <p>N = no Y = yes</p> <p><i>Default Value:</i> Y</p>
g = print interpretation line above code	<p><i>Accepted Values:</i></p> <p>N = no Y = yes</p> <p><i>Default Value:</i> N</p>
e = print check digit	<p><i>Accepted Values:</i></p> <p>N = no Y = yes</p> <p><i>Default Value:</i> Y</p>



Example • This is an example of a UPC-E bar code:

ZPL II CODE	UPC-E BAR CODE								
<pre style="margin: 0;">^XA ^FO150,100^BY3 ^B9N,100,Y,N,Y ^FD1230000045^FS ^XZ</pre>									
UPC-E BAR CODE CHARACTERS									
0	1	2	3	4	5	6	7	8	9

Rules for Proper Product Code Numbers

- If the last three digits in the manufacturer’s number are 000, 100, or 200, valid product code numbers are 00000 to 00999.
- If the last three digits in the manufacturer’s number are 300, 400, 500, 600, 700, 800, or 900, valid product code numbers are 00000 to 00099.
- If the last two digits in the manufacturer’s number are 10, 20, 30, 40, 50, 60, 70, 80, or 90, valid product code numbers are 00000 to 00009.
- If the manufacturer’s number does not end in zero (0), valid product code numbers are 00005 to 00009.

^BA – Code 93 Bar Code

Description The ^BA command creates a variable length, continuous symbology. The Code 93 bar code is used in many of the same applications as Code 39. It uses the full 128-character ASCII set. ZPL II, however, does not support ASCII control codes or escape sequences. It uses the substitute characters shown below.

Control Code	ZPL II Substitute
Ctrl \$	&
Ctrl %	'
Ctrl /	(
Ctrl +)

Each character in the Code 93 bar code is composed of six elements: three bars and three spaces. Although invoked differently, the human-readable interpretation line prints as though the control code has been used.

- ^BA supports a fixed print ratio.
- Field data (^FD) is limited to the width (or length, if rotated) of the label.

Format ^BAo,h,f,g,e



Important • If additional information about the Code 93 bar code is required, go to www.aimglobal.org.

Parameters	Details
o = orientation	<p><i>Accepted Values:</i></p> <p>N = normal R = rotated 90 degrees (clockwise) I = inverted 180 degrees B = read from bottom up, 270 degrees</p> <p><i>Default Value:</i> current ^FW value</p>
h = bar code height (in dots)	<p><i>Accepted Values:</i> 1 to 32000</p> <p><i>Default Value:</i> value set by ^BY</p>
f = print interpretation line	<p><i>Accepted Values:</i></p> <p>N = no Y = yes</p> <p><i>Default Value:</i> Y</p>
g = print interpretation line above code	<p><i>Accepted Values:</i></p> <p>N = no Y = yes</p> <p><i>Default Value:</i> N</p>

Parameters	Details
e = print check digit	<p><i>Accepted Values:</i></p> <p>N = no</p> <p>Y = yes</p> <p><i>Default Value: N</i></p>

➔ **Example** • This is an example of a Code 93 bar code:

ZPL II CODE	CODE 93 BAR CODE																																																																		
<pre> ^XA ^FO100,75^BY3 ^BAN,100,Y,N,N ^FD12345ABCDE^FS ^XZ </pre>																																																																			
CODE 93 BAR CODE CHARACTERS																																																																			
<table border="0"> <tr> <td></td><td>0</td><td>1</td><td>2</td><td>3</td><td>4</td><td>5</td><td>6</td><td>7</td><td>8</td><td>9</td> </tr> <tr> <td>A</td><td>B</td><td>C</td><td>D</td><td>E</td><td>F</td><td>G</td><td>H</td><td>I</td><td>J</td><td>K</td> </tr> <tr> <td>L</td><td>M</td><td>N</td><td>O</td><td>P</td><td>Q</td><td>R</td><td>S</td><td>T</td><td>U</td><td>V</td> </tr> <tr> <td>W</td><td>X</td><td>Y</td><td>Z</td><td>-</td><td>.</td><td>\$</td><td>/</td><td>+</td><td>%</td><td>&</td> </tr> <tr> <td></td><td></td><td></td><td></td><td>'</td><td>(</td><td>)</td><td></td><td></td><td></td><td></td> </tr> <tr> <td></td><td></td><td></td><td></td><td></td><td></td><td></td><td></td><td></td><td></td><td>SPACE</td> </tr> </table> <p>□ Denotes an internal start/stop character that must precede and follow every bar code message.</p>			0	1	2	3	4	5	6	7	8	9	A	B	C	D	E	F	G	H	I	J	K	L	M	N	O	P	Q	R	S	T	U	V	W	X	Y	Z	-	.	\$	/	+	%	&					'	()															SPACE
	0	1	2	3	4	5	6	7	8	9																																																									
A	B	C	D	E	F	G	H	I	J	K																																																									
L	M	N	O	P	Q	R	S	T	U	V																																																									
W	X	Y	Z	-	.	\$	/	+	%	&																																																									
				'	()																																																													
										SPACE																																																									

Comments All control codes are used in pairs.

Code 93 is also capable of encoding the full 128-character ASCII set. For more details, see [Table 4 on page 87](#).

Full ASCII Mode for Code 93

Code 93 can generate the full 128-character ASCII set using paired characters as shown in the following tables.

Table 4 •

ASCII	Code 93	ASCII	Code 93
NUL	'U	SP	Space
SOH	&A	!	(A
STX	&B	"	(B
ETX	&C	#	(C
EOT	&D	\$	(D
ENQ	&E	%	(E
ACK	&F	&	(F
BEL	&G	'	(G
BS	&H	((H
HT	&I)	(I
LF	&J	*	(J
VT	&K	++	++
FF	&L	,	(L
CR	&M	-	-
SO	&N	.	.
SI	&O	/	/
DLE	&P	0	O
DC1	&Q	1	1
DC2	&R	2	2
DC3	&S	3	3
DC4	&T	4	4
NAK	&U	5	5
SYN	&V	6	6
ETB	&W	7	7
CAN	&X	8	8
EM	&Y	9	9
SUB	&Z	:	(Z
ESC	'A	;	'F
FS	'B	<	'G
FS	'C	=	'H
RS	'D	>	'I
US	'E	?	'J

Table 5 •

ASCII	Code 93	ASCII	Code 93
@	'V	'	'W
A	A	a)A
B	B	b)B
C	C	c)C
D	D	d)D
E	E	e)E
F	F	f)F
G	G	g)G
H	H	h)H
I	I	i)I
J	J	j)J
K	K	k)K
L	L	l)L
M	M	m)M
N	N	n)N
O	O	o)O
P	P	p)P
Q	Q	q)Q
R	R	r)R
S	S	s)S
T	T	t)T
U	U	u)U
V	V	v)V
W	W	w)W
X	X	x)X
Y	Y	y)Y
Z	Z	z)Z
['K	{	'P
\	'L		'Q
]	'M	}	'R
^	'N	~	'S
_	'O	DEL	'T

^BB – CODABLOCK Bar Code

Description The ^BB command produces a two-dimensional, multirow, stacked symbology. It is ideally suited for applications that require large amounts of information.

Depending on the mode selected, the code consists of one to 44 stacked rows. Each row begins and ends with a start and stop pattern.

- CODABLOCK A supports variable print ratios.
- CODABLOCK E and F support only fixed print ratios.

Format ^BB*o,h,s,c,r,m*



Important • If additional information about the CODABLOCK bar code is required, go to www.aimglobal.org.

Parameters	Details
o = orientation	<p><i>Accepted Values:</i></p> <ul style="list-style-type: none"> N = normal R = rotated 90 degrees (clockwise) I = inverted 180 degrees B = read from bottom up, 270 degrees <p><i>Default Value:</i> N</p>
h = bar code height for individual rows (in dots)	<p><i>Accepted Values:</i> 2 to 32000</p> <p><i>Default Value:</i> 8</p> <p>This number, multiplied by the module, equals the height of the individual row in dots.</p>
s = security level	<p><i>Accepted Values:</i></p> <ul style="list-style-type: none"> N = no Y = yes <p><i>Default Value:</i> Y</p> <p>Security level determines whether symbol check-sums are generated and added to the symbol. Check sums are never generated for single-row symbols. This can be turned off only if parameter m is set to A.</p>
c = number of characters per row (data columns)	<p><i>Accepted Values:</i> 2 to 62 characters</p> <p>This is used to encode a CODABLOCK symbol. It gives the you control over the width of the symbol.</p>

Parameters	Details
<p><i>r</i> = number of rows to encode</p>	<p><i>Accepted Values:</i> for CODABLOCK A: 1 to 22 for CODABLOCK E and F: 2 to 4</p> <ul style="list-style-type: none"> • If values for <i>c</i> and <i>r</i> are not specified, a single row is produced. • If a value for <i>r</i> is not specified, and <i>c</i> exceeds the maximum range, a single row equal to the field data length is produced. • If a value for <i>c</i> is not specified, the number of characters per row is derived by dividing the field data by the value of <i>r</i>. • If the <i>s</i> parameter is set to the default of Y, then the checksum characters that are included count as two data characters . <p>For example, if <i>c</i> = 6, <i>r</i> is set to 3 and <i>s</i> is set to N, then up to 18 characters can be used (6 x 3). However, if <i>s</i> is set to Y, then only 16 character can be used.</p> <ul style="list-style-type: none"> • If the data field contains primarily numeric data, fewer than the specified rows might be printed. If the field data contains several shift and code-switch characters, more than the specified number of rows might be printed.
<p><i>m</i> = mode</p>	<p><i>Accepted Values:</i> A, E, F</p> <p>CODABLOCK A uses the Code 39 character set. CODABLOCK F uses the Code 128 character set. CODABLOCK E uses the Code 128 character set and automatically adds FNC1.</p> <p><i>Default Value:</i> F</p>

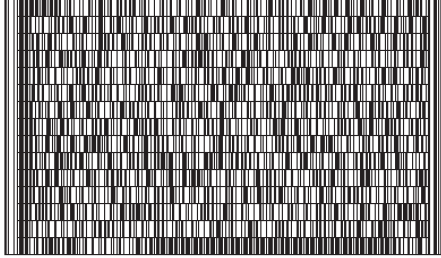

Example • This is an example of a CODABLOCK bar code:

ZPL II CODE	CODABLOCK BAR CODE
<pre> ^XA ^BY2,3 ^FO10,10^BBN,30,,30,44,E ^FDZebra Technologies Corporation strives to be the expert supplier of innovative solutions to speciality demand labeling and ticketing problems of business and government. We will attract and retain the best people who will understand our customer's needs and provide them with systems, hardware, software, consumables and service offering the best value, high quality, and reliable performance, all delivered in a timely manner.^FS ^XZ </pre>	

Special Considerations for the ^BY Command When Using ^BB

The parameters for the ^BYw,r,h command, when used with a ^BB code, are as follows:

w = module width (in dots)

Accepted Values: 2 to 10 (CODABLOCK A only)

Default Value: 2

r = ratio

Fixed Value: 3 (ratio has no effect on CODABLOCK E or F)

h = height of bars (in dots)

Accepted Values: 1 to 32,32000

Default Value: 10

CODABLOCK uses this as the overall symbol height only when the row height is not specified in the ^BB h parameter.

Special Considerations for ^FD Character Set When Using ^BB

The character set sent to the printer depends on the mode selected in parameter m.

CODABLOCK A: CODABLOCK A uses the same character set as Code 39. If any other character is used in the ^FD statement, either no bar code is printed or an error message is printed (if ^CV is active).

CODABLOCK E: The Automatic Mode includes the full ASCII set except for those characters with special meaning to the printer. Function codes or the Code 128 Subset A <nu1> character can be inserted using of the ^FH command.

<fnc1> = 80 hex	<fnc3> = 82 hex
<fnc2> = 81 hex	<fnc4> = 83 hex
<nu1> = 84 hex	

For any other character above 84 hex, either no bar code is printed or an error message is printed (if ^CV is active).

CODABLOCK F: CODABLOCK F uses the full ASCII set, except for those characters with special meaning to the printer. Function codes or the Code 128 Subset A <nu1> character can be inserted using of the ^FH command.

<fnc1> = 80 hex	<fnc3> = 82 hex
<fnc2> = 81 hex	<fnc4> = 83 hex
<nu1> = 84 hex	

^BC – Code 128 Bar Code (Subsets A, B, and C)

Description The ^BC command creates the Code 128 bar code, a high-density, variable length, continuous, alphanumeric symbology. It was designed for complexly encoded product identification.

Code 128 has three subsets of characters. There are 106 encoded printing characters in each set, and each character can have up to three different meanings, depending on the character subset being used. Each Code 128 character consists of six elements: three bars and three spaces.

- ^BC supports a fixed print ratio.
- Field data (^FD) is limited to the width (or length, if rotated) of the label.

Format ^BCo,h,f,g,e,m



Important • If additional information about the Code 128 bar code is required, go to www.aimglobal.org.

Parameters	Details
o = orientation	<p><i>Accepted Values:</i></p> <p>N = normal R = rotated 90 degrees (clockwise) I = inverted 180 degrees B = read from bottom up, 270 degrees</p> <p><i>Default Value:</i> current ^FW value</p>
h = bar code height (in dots)	<p><i>Accepted Values:</i> 1 to 32000</p> <p><i>Default Value:</i> value set by ^BY</p>
f = print interpretation line	<p><i>Accepted Values:</i> Y (yes) or N (no)</p> <p><i>Default Value:</i> Y</p> <p>The interpretation line can be printed in any font by placing the font command before the bar code command.</p>
g = print interpretation line above code	<p><i>Accepted Values:</i> Y (yes) or N (no)</p> <p><i>Default Value:</i> N</p>
e = UCC check digit	<p><i>Accepted Values:</i> Y (turns on) or N (turns off)</p> <p>Mod 103 check digit is always there. It cannot be turned on or off. Mod 10 and 103 appear together with e turned on.</p> <p><i>Default Value:</i> N</p>

Parameters	Details
<p>m = mode</p>	<p><i>Accepted Values:</i></p> <p>N = no selected mode</p> <p>U = UCC Case Mode</p> <ul style="list-style-type: none"> • More than 19 digits in ^FD or ^SN are eliminated. • Fewer than 19 digits in ^FD or ^SN add zeros to the right to bring the count to 19. This produces an invalid interpretation line. <p>A = Automatic Mode</p> <p>This analyzes the data sent and automatically determines the best packing method. The full ASCII character set can be used in the ^FD statement — the printer determines when to shift subsets. A string of four or more numeric digits causes an automatic shift to Subset C.</p> <p>D = UCC/EAN Mode (x.11.x and newer firmware)</p> <p>This allows dealing with UCC/EAN with and without chained application identifiers. The code starts in the appropriate subset followed by FNC1 to indicate a UCC/EAN 128 bar code. The printer automatically strips out parentheses and spaces for encoding, but prints them in the human-readable section. The printer automatically determines if a check digit is required, calculate it, and print it. Automatically sizes the human readable.</p> <p><i>Default Value:</i> N</p>



Example 1 • This is an example of a Code 128 bar code:

ZPL II CODE	CODE 128 BAR CODE
<pre> ^XA ^FO100,100^BY3 ^BCN,100,Y,N,N ^FD123456^FS ^XZ </pre>	

Code 128 Subsets

The Code 128 character subsets are referred to as Subset A, Subset B, and Subset C. A subset can be selected in these ways:

- A special Invocation Code can be included in the field data (^FD) string associated with that bar code.
- The desired Start Code can be placed at the beginning of the field data. If no Start Code is entered, Subset B are used.

To change subsets within a bar code, place the Invocation Code at the appropriate points within the field data (^FD) string. The new subset stays in effect until changed with the Invocation Code. For example, in Subset C, >7 in the field data changes the Subset to A.

Table 6 shows the Code 128 Invocation Codes and Start Characters for the three subsets.

Table 6 • Code 128 Invocation Characters

Invocation Code	Decimal Value	Subset A Character	Subset B Character	Subset C Character
<<	62			
>0	30	>	>	
>=	94		~	
>1	95	USQ	DEL	
>2	96	FNC 3	FNC 3	
>3	97	FNC 2	FNC 2	
>4	98	SHIFT	SHIFT	
>5	99	CODE C	CODE C	
>6	100	CODE B	FNC 4	CODE B
>7	101	FNC 4	CODE A	CODE A
>8	102	FNC 1	FNC 1	FNC 1
Start Characters				
>9	103	Start Code A	(Numeric Pairs give Alpha/Numerics)	
>:	104	Start Code B	(Normal Alpha/Numeric)	
>;	105	Start Code C	(All numeric (00 - 99))	

Table 7 shows the character sets for Code 128:

Table 7 •

Value	Code A	Code B	Code C	Value	Code A	Code B	Code C
0	SP	SP	00	53	U	U	53
1	!	!	01	54	V	V	54
2	"	"	02	55	W	W	55
3	#	#	03	56	X	X	56
4	\$	\$	04	57	Y	Y	57
5	%	%	05	58	Z	Z	58
6	&	&	06	59	[[59
7	'	'	07	60	\	\	60
8	((08	61]]	61
9))	09	62	^	^	62
10	*	*	10	63			63
11	+	+	11	64	NUL	.	64
12	,	,	12	65	SOH	a	65
13	-	-	13	66	STX	b	66
14	.	.	14	67	ETX	c	67
15	/	/	15	68	EOT	d	68
16	0	0	16	69	ENQ	e	69
17	1	1	17	70	ACK	f	70
18	2	2	18	71	BEL	g	71
19	3	3	19	72	BS	h	72
20	4	4	20	73	HT	i	73
21	5	5	21	74	LF	j	74
22	6	6	22	75	VT	k	75
23	7	7	23	76	FF	l	76
24	8	8	24	77	CR	m	77
25	9	9	25	78	SO	n	78
26	:	:	26	79	SI	o	79
27	;	;	27	80	DLE	p	80
28	<	<	28	81	DC1	q	81
29	=	=	29	82	DC2	r	82
30	>	>	30	83	DC3	s	83
31	?	?	31	84	DC4	t	84
32	@	@	32	85	NAK	u	85
33	A	A	33	86	SYN	v	86
34	B	B	34	87	ETB	w	87
35	C	C	35	88	CAN	x	88
36	D	D	36	89	EM	y	89
37	E	E	37	90	SUB	z	90
38	F	F	38	91	ESC	{	91
39	G	G	39	92	FS		92
40	H	H	40	93	GS	}	93
41	I	I	41	94	RS	~	94
42	J	J	42	95	US	DEL	95
43	K	K	43	96	FNC3	FNC3	96
44	L	L	44	97	FNC2	FNC2	97
45	M	M	45	98	SHIFT	SHIFT	98
46	N	N	46	99	Code C	Code C	99
47	O	O	47	100	Code B	FNC4	Code B
48	P	P	48	101	FNC4	Code A	Code A
49	Q	Q	49	102	FNC1	FNC1	FNC1
50	R	R	50	103		START (Code A)	
51	S	S	51	104		START (Code B)	
52	T	T	52	105		START (Code C)	



Example 2 • Figures A and B are examples of identical bar codes, and Figure C is an example of switching from Subset C to B to A, as follows:

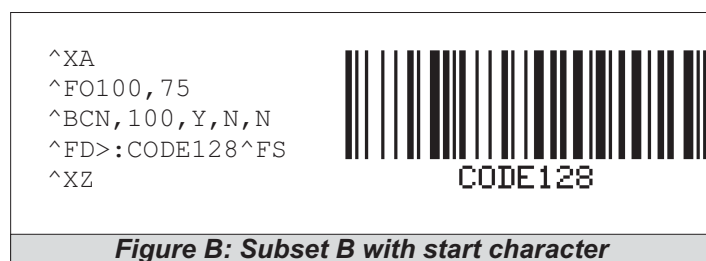
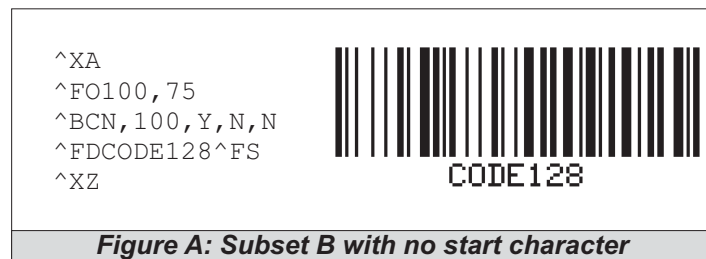

Because Code 128 Subset B is the most commonly used subset, ZPL II defaults to Subset B if no start character is specified in the data string.

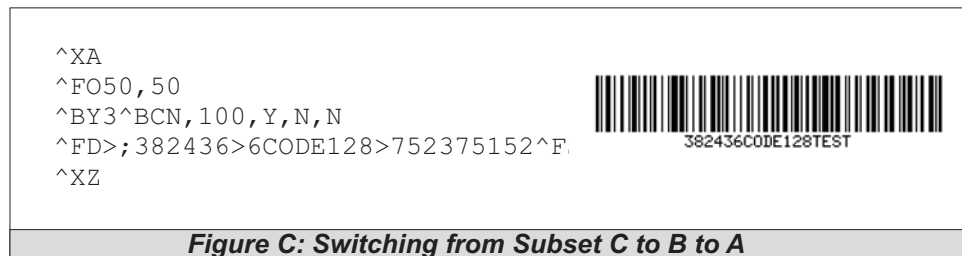

How ^BC Works Within a ZPL II Script

^XA – the first command starts the label format.

^FO100,75 – the second command sets the field origin at 100 dots across the x-axis and 75 dots down the y-axis from the upper-left corner.

^BCN,100,Y,N,N – the third command calls for a Code 128 bar code to be printed with no rotation (N) and a height of 100 dots. An interpretation line is printed (Y) below the bar code (N). No UCC check digit is used (N).

^FDCODE128^FS (Figure A) **^FD>:CODE128^FS** (Figure B) – the field data command specifies the content of the bar code.

^XZ – the last command ends the field data and indicates the end of the label.

The interpretation line prints below the code with the UCC check digit turned off.

The ^FD command for Figure A does not specify any subset, so Subset B is used. In Figure B, the ^FD command specifically calls Subset B with the >: Start Code. Although ZPL II defaults to Code B, it is good practice to include the Invocation Codes in the command.

Code 128 – Subset B is programmed directly as ASCII text, except for values greater than 94 decimal and a few special characters that must be programmed using the invocation codes. Those characters are:

^ > ~

➔ **Example 3 • Code 128 – Subsets A and C**

Code 128, Subsets A and C are programmed in pairs of digits, 00 to 99, in the field data string. For details, see [Table 6 on page 95](#).

In Subset A, each pair of digits results in a single character being encoded in the bar code; in Subset C, characters are printed as entered. Figure E below is an example of Subset A (>9 is the Start Code for Subset A).

Nonintegers programmed as the first character of a digit pair (D2) are ignored. However, nonintegers programmed as the second character of a digit pair (2D) invalidate the entire digit pair, and the pair is ignored. An extra unpaired digit in the field data string just before a code shift is also ignored.

Figure C and Figure D below are examples of Subset C. Notice that the bar codes are identical. In the program code for Figure D, the D is ignored and the 2 is paired with the 4.

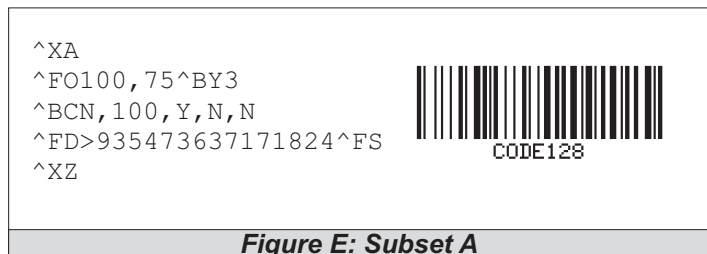
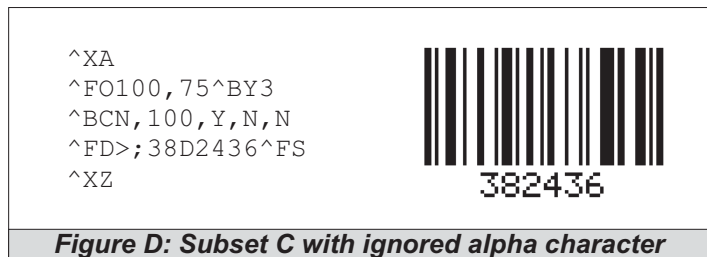
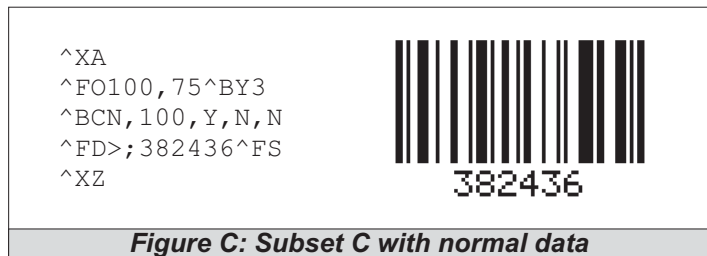

The UCC/EAN-128 Symbology

The symbology specified for the representation of Application Identifier data is UCC/EAN-128, a variant of Code 128, exclusively reserved to EAN International and the Uniform Code Council (UCC).



Note • It is not intended to be used for data to be scanned at the point of sales in retail outlets.

UCC/EAN-128 offers several advantages. It is one of the most complete, alphanumeric, one-dimensional symbologies available today. The use of three different character sets (A, B and C), facilitates the encoding of the full 128 ASCII character set. Code 128 is one of the most compact linear bar code symbologies. Character set C enables numeric data to be represented in a double density mode. In this mode, two digits are represented by only one symbol character saving valuable space. The code is concatenated. That means that multiple AIs and their fields may be combined into a single bar code. The code is also very reliable. Code 128 symbols use two independent self-checking features which improves printing and scanning reliability.

UCC/EAN-128 bar codes always contain a special non-data character known as function 1 (FNC 1), which follows the start character of the bar code. It enables scanners and processing software to auto-discriminate between UCC/EAN-128 and other bar code symbologies, and subsequently only process relevant data.

The UCC/EAN-128 bar code is made up of a leading quiet zone, a Code 128 start character A, B, or C, a FNC 1 character, Data (Application Identifier plus data field), a symbol check character, a stop character, and a trailing quiet zone.

UCC/EAN, UCC/128 are a couple of ways you'll hear someone refer to the code. This just indicates that the code is structured as dictated by the application identifiers that are used.

SSCC (Serial Shipping Container Code) formatted following the data structure layout for Application Identifier 00. See [Table 8, UCC/EAN Application Identifier on page 102](#). It could be 00 which is the SSCC code. The customer needs to let us know what application identifiers are used for their bar code so we can help them.

There are several ways of writing the code to print the code to Application Identifier '00' structure.

Using N for the mode (m) parameter

➔ **Example 1** • This example shows with application identifier 00 structure:

ZPL II CODE	N FOR THE M PARAMETER
<pre> ^XA ^FO90,200^BY4 ^BCN,256,Y,N,Y,N ^FD>;>80012345123451234512^FS ^XZ </pre>	

- >;>8' sets it to subset C, function 1
- '00' is the application identifier followed by '17 characters', the check digit is selected using the 'Y' for the (e) parameter to automatically print the 20th character.
- you are not limited to 19 characters with mode set to N

Using U for the mode (m) parameter

➔ **Example 1** • The example shows the application identifier 00 format:

ZPL II CODE	U FOR THE M PARAMETER
<pre> ^XA ^FO90,200 ^BY4^BC,256,Y,N,,U ^FD0012345123451234512^FS ^XZ </pre>	

UCC Case Mode

- Choosing **U** selects UCC Case mode. You will have exactly 19 characters available in ^FD.
- Subset C using FNC1 values are automatically selected.
- Check digit is automatically inserted.

Using D for the mode (m) parameter

➔ **Example 1** • This example shows application identifier 00 format ((x.11.x or later):

ZPL II CODE	D FOR THE M PARAMETER
<pre> ^XA ^FO50,200^BCN,150,Y,N,,D ^FD(00)10084423 7449200940^FS ^XZ </pre>	

(0 at end of field data is a bogus character that is inserted as a place holder for the check digit the printer will automatically insert.

- Subset C using FNC1 values are automatically selected.
- Parentheses and spaces can be in the field data. '00' application identifier, followed by 17 characters, followed by bogus check digit place holder.
- Check digit is automatically inserted. The printer will automatically calculate the check digit and put it into the bar code and interpretation line.
- The interpretation line will also show the parentheses and spaces but will strip them out from the actual bar code.

Printing the Interpretation Line

➔ **Example 1** • This example shows printing the interpretation in a different font with firmware x.11.x or later:

ZPL II CODE	INTERPRETATION LINE
<pre> ^XA ^FO50,200 ^A0N,40,30^BCN,150,Y,N,Y ^FD>;>80012345123451234512^FS ^XZ </pre>	

The font command (^A0N,40,30) can be added and changed to alter the font and size of the interpretation line.

With firmware version later than x.10.x

- A separate text field needs to be written.
- The interpretation line needs to be turned off.
- ^A0N,50,40 is the font and size selection for the separate text field.
- You have to make sure you enter the correct check digit in the text field.

- Creating a separate text field allows you to format the interpretation line with parentheses and spaces.

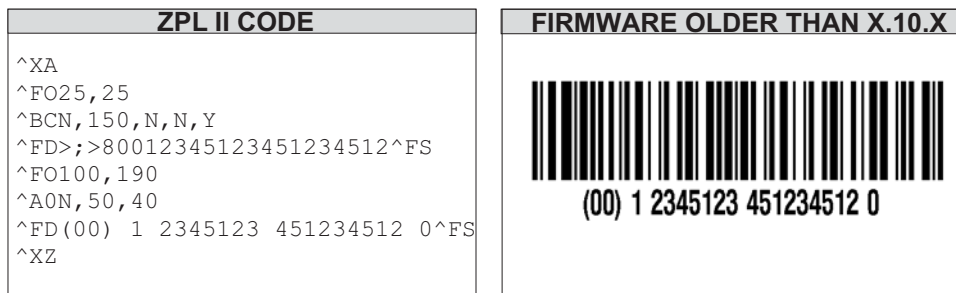

Application Identifiers — UCC/EAN APPLICATION IDENTIFIER

An Application Identifier is a prefix code used to identify the meaning and the format of the data that follows it (data field).

There are AIs for identification, traceability, dates, quantity, measurements, locations, and many other types of information.

For example, the AI for batch number is 10, and the batch number AI is always followed by an alphanumeric batch code not to exceed 20-characters.

The UCC/EAN Application Identifiers provide an open standard that can be used and understood by all companies in the trading chain, regardless of the company that originally issued the codes.

Table 8 • UCC/EAN Application Identifier

Data Content	AI	Plus The Following Data Structure
Serial Shipping Container Code (SSCC)	00	exactly 18 digits
Shipping Container Code	01	exactly 14 digits
Batch Numbers	10	up to 20 alpha numerics
Production Date (YYMMDD)	11	exactly 6 digits
Packaging Date (YYMMDD)	13	exactly 6 digits
Sell By Date (YYMMDD)	15	exactly 6 digits
Expiration Date (YYMMDD)	17	exactly 6 digits
Product Variant	20	exactly 2 digits
Serial Number	21	up to 20 alpha numerics
HIBCC Quantity, Date, Batch and Link	22	up to 29 alpha numerics
Lot Number	23 ^a	up to 19 alpha numerics
Quantity Each	30	

a. Plus one digit for length indication.

b. Plus one digit for decimal point indication.

Table 8 • UCC/EAN Application Identifier

Data Content	AI	Plus The Following Data Structure
Net Weight (Kilograms)	310 ^b	exactly 6 digits
Length, Meters	311 ^b	exactly 6 digits
Width or Diameter (Meters)	312 ^b	exactly 6 digits
Depths (Meters)	313 ^b	exactly 6 digits
Area (Sq. Meters)	314 ^b	exactly 6 digits
Volume (Liters)	315 ^b	exactly 6 digits
Volume (Cubic Meters)	316 ^b	exactly 6 digits
Net Weight (Pounds)	320 ^b	exactly 6 digits
Customer PO Number	400	up to 29 alpha numerics
Ship To (Deliver To) Location Code using EAN 13 or DUNS Number with leading zeros	410	exactly 13 digits
Bill To (Invoice To) Location Code using EAN 13 or DUNS Number with leading zeros	411	exactly 13 digits
Purchase from	412	exactly 13 digits
Ship To (Deliver To) Postal Code within single postal authority	420	up to 9 alpha numerics
Ship To (Deliver To) Postal Code with 3-digit ISO Country Code Prefix	421	3 digits plus up to 9 alpha numerics
Roll Products - width, length, core diameter, direction and splices	8001	exactly 14 digits
Electronic Serial number for cellular mobile phone	8002	up to 20 alpha numerics

- a.** Plus one digit for length indication.
b. Plus one digit for decimal point indication.



Note • Table 8 is a partial table showing the application identifiers. For more current and complete information, search the Internet for **UCC Application Identifier**.

For date fields that only need to indicate a year and month, the day field is set to **00**.

Chaining several application identifiers (firmware x.11.x or later)

The FNC1, which is invoked by >8, is inserted just before the AI's so that the scanners reading the code sees the FNC1 and knows that an AI follows.

→ **Example 1** • This is an example with the mode parameter set to **A** (automatic):

```

^XA
^BY2,2.5,193
^F033,400
^BCN,,N,N,N,A
^FD>;>80204017773003486100008535>8910001>837252^FS
^FT33,625^AEN,0,0^FD(02)04017773003486(10)0008535(91)0001(
37)252^FS
^XZ

```

→ **Example 2** • This is an example with the mode parameter set to **U**:

```

^XA
^BY3,2.5,193
^F033,200
^BCN,,N,N,N,U
^FD>;>80204017773003486>8100008535>8910001>837252^FS
^FT33,455^A0N,30,30^FD(02)04017773003486(10)0008535(91)000
1(37)252^FS
^XZ

```

→ **Example 3** • This is an example with the mode parameter set to **D***:

```

^XA
^PON
^LH0,0
^BY2,2.5,145
^F0218,343
^BCB,,Y,N,N,D
^FD(91)0005886>8(10)0000410549>8(99)05^FS
^XZ

```

D* — When trying to print the last Application Identifier with an odd number of characters, a problem existed when printing EAN128 bar codes using Mode D. The problem was fixed in firmware version V60.13.0.6.

^BD - UPS MaxiCode Bar Code

Description The ^BD command creates a two-dimensional, optically read (not scanned) code. This symbology was developed by UPS (United Parcel Service).

Notice that there are no additional parameters for this code and it does not generate an interpretation line. The ^BY command has no effect on the UPS MaxiCode bar code. However, the ^CV command can be activated.

Format ^BDm,n,t

Parameters	Details
m = mode	<p><i>Accepted Values:</i></p> <ul style="list-style-type: none"> 2 = structured carrier message: numeric postal code (U.S.) 3 = structured carrier message: alphanumeric postal code (non-U.S.) 4 = standard symbol, secretary 5 = full EEC 6 = reader program, secretary <p><i>Default Value: 2</i></p>
n = symbol number	<p><i>Accepted Values: 1 to 8</i> can be added in a structured document</p> <p><i>Default Value: 1</i></p>
t = total number of symbols	<p><i>Accepted Values: 1 to 8</i>, representing the total number of symbols in this sequence</p> <p><i>Default Value: 1</i></p>

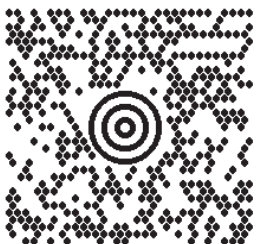

Example • This is an example of UPS MAXICODE - MODE 2 bar code:

ZPL II CODE	UPS MAXICODE - MODE 2
<pre> ^XA ^FO50,50 ^CVY ^BD^FH^FD001840152382802 []>_1E01_1D961Z00004951_1DUPSN 1D_06X610_1D159_1D1234567_1D1/1_ 1D_1DY_1D634 ALPHA DR_ 1DPITTSBURGH_1DPA_1E_04^FS ^FO30,300^A0,30,30^FDMODE2^FS ^XZ </pre>	

Special Considerations for ^FD when Using ^BD

The ^FD statement is divided into two parts: a high priority message (**hpm**) and a low priority message (**lpm**). There are two types of high priority messages. One is for a U.S. Style Postal Code; the other is for a non-U.S. Style Postal Code. The syntax for either of these high priority messages must be exactly as shown or an error message is generated.

Format ^FD <hpm><lpm>

This table identifies the parameters for this format:

Parameters	Details
<hpm> = high priority message (applicable only in Modes 2 and 3)	<p><i>Accepted Values: 0 to 9, except where noted</i></p> <p>U.S. Style Postal Code (Mode 2)</p> <p><hpm> = aaabbbccccdddd</p> <p>aaa = three-digit class of service</p> <p>bbb = three-digit country zip code</p> <p>cccc = five-digit zip code</p> <p>dddd = four-digit zip code extension (if none exists, four zeros (0000) must be entered)</p> <p>non-U.S. Style Postal Code (Mode 3)</p> <p><hpm> = aaabbbcccccc</p> <p>aaa = three-digit class of service</p> <p>bbb = three-digit country zip code</p> <p>cccc = six-digit zip code (A through Z or 0 to 9)</p>
<lpm> = low priority message (only applicable in Modes 2 and 3)	<p>GS is used to separate fields in a message (0x1D). RS is used to separate format types (0x1E). EOT is the end of transmission characters.</p> <p>Message Header []>RS</p> <p>Transportation Data</p> <p>Format Header01GS96</p> <p>Tracking Number*<tracking number></p> <p>SCAC*GS<SCAC></p> <p>UPS Shipper NumberGS<shipper number></p> <p>Julian Day of PickupGS<day of pickup></p> <p>Shipment ID NumberGS<shipment ID number></p> <p>Package n/xGS<n/x></p> <p>Package WeightGS<weight></p> <p>Address ValidationGS<validation></p> <p>Ship to Street AddressGS<street address></p> <p>Ship to CityGS<city></p> <p>Ship to StateGS<state></p> <p>RSRS</p> <p>End of MessageEOT</p> <p>(* Mandatory Data for UPS)</p>

Comments

- The formatting of `<hpm>` and `<lpm>` apply only when using Modes 2 and 3. Mode 4, for example, takes whatever data is defined in the `^FD` command and places it in the symbol.
- UPS requires that certain data be present in a defined manner. When formatting MaxiCode data for UPS, always use uppercase characters. When filling in the *fields* in the `<lpm>` for UPS, follow the data size and types specified in *Guide to Bar Coding with UPS*.
- If you do not choose a mode, the default is Mode 2. If you use non-U.S. Postal Codes, you probably get an error message (invalid character or message too short). When using non-U.S. codes, use Mode 3.
- ZPL II doesn't automatically change your mode based on the zip code format.
- When using special characters, such as GS, RS, or EOT, use the `^FH` command to tell ZPL II to use the hexadecimal value following the underscore character (`_`).

^BE – EAN-13 Bar Code

Description The ^BE command is similar to the UPC-A bar code. It is widely used throughout Europe and Japan in the retail marketplace.

The EAN-13 bar code has 12 data characters, one more data character than the UPC-A code. An EAN-13 symbol contains the same number of bars as the UPC-A, but encodes a 13th digit into a parity pattern of the left-hand six digits. This 13th digit, in combination with the 12th digit, represents a country code.

- ^BE supports fixed print ratios.
- Field data (^FD) is limited to exactly 12 characters. ZPL II automatically truncates or pads on the left with zeros to achieve the required number of characters.
- When using JAN-13 (Japanese Article Numbering), a specialized application of EAN-13, the first two non-zero digits sent to the printer must be 49.

Format ^BEo,h,f,g



Note • Use Interleaved 2 of 5 for UCC and EAN 14.



Important • If additional information about the EAN-13 bar code is required, go to www.aimglobal.org.

Parameters	Details
o = orientation	<p><i>Accepted Values:</i></p> <p>N = normal R = rotated 90 degrees (clockwise) I = inverted 180 degrees B = read from bottom up, 270 degrees</p> <p><i>Default Value:</i> current ^FW value</p>
h = bar code height (in dots)	<p><i>Accepted Values:</i> 1 to 32000</p> <p><i>Default Value:</i> value set by ^BY</p>
f = print interpretation line	<p><i>Accepted Values:</i></p> <p>N = no Y = yes</p> <p><i>Default Value:</i> Y</p>
g = print interpretation line above code	<p><i>Accepted Values:</i></p> <p>N = no Y = yes</p> <p><i>Default Value:</i> N</p>



Example • This is an example of an EAN-13 bar code:

ZPL II CODE	EAN-13 BAR CODE								
<pre> ^XA ^FO100,100^BY3 ^BEN,100,Y,N ^FD12345678^FS ^XZ </pre>									
EAN-13 BAR CODE CHARACTERS									
0	1	2	3	4	5	6	7	8	9

Comments The EAN-13 bar code uses the Mod 10 check-digit scheme for error checking. For more information on Mod 10, see [Mod 10 Check Digit on page 1224](#).

^BF – MicroPDF417 Bar Code

Description The ^BF command creates a two-dimensional, multi-row, continuous, stacked symbology identical to PDF417, except it replaces the 17-module-wide start and stop patterns and left/right row indicators with a unique set of 10-module-wide row address patterns. These reduce overall symbol width and allow linear scanning at row heights as low as 2X.

MicroPDF417 is designed for applications with a need for improved area efficiency but without the requirement for PDF417's maximum data capacity. It can be printed only in specific combinations of rows and columns up to a maximum of four data columns by 44 rows.

Field data (^FD) and field hexadecimal (^FH) are limited to:

- 250 7-bit characters
- 150 8-bit characters
- 366 4-bit numeric characters

Format ^BFo,h,m

Parameters	Details
o = orientation	<p><i>Accepted Values:</i></p> <ul style="list-style-type: none"> N = normal R = rotated 90 degrees (clockwise) I = inverted 180 degrees B = read from bottom up, 270 degrees <p><i>Default Value:</i> current ^FW value</p>
h = bar code height (in dots)	<p><i>Accepted Values:</i> 1 to 9999</p> <p><i>Default Value:</i> value set by ^BY or 10 (if no ^BY value exists).</p>
m = mode	<p><i>Accepted Values:</i> 0 to 33 (see Table 9, MicroPDF417 Mode on page 111)</p> <p><i>Default Value:</i> 0 (see Table 9)</p>



Example • This is an example of a MicroPDF417 bar code:

ZPL II CODE
<pre> ^XA ^FO100,100^BY6 ^BFN,8,3 ^FDABCDEF GHIJKLMNOPQRSTUVWXYZ^FS ^XZ </pre>



To encode data into a MicroPDF417 bar code, complete these steps:

1. Determine the type of data to be encoded (for example, ASCII characters, numbers, 8-bit data, or a combination).
2. Determine the maximum amount of data to be encoded within the bar code (for example, number of ASCII characters, quantity of numbers, or quantity of 8-bit data characters).
3. Determine the percentage of check digits that are used within the bar code. The higher the percentage of check digits that are used, the more resistant the bar code is to damage — however, the size of the bar code increases.
4. Use [Table 9](#) with the information gathered from the questions above to select the mode of the bar code.

Table 9 • MicroPDF417 Mode

Mode (M)	Number of Data Columns	Number of Data Rows	% of Cws for EC	Max Alpha Characters	Max Digits
0	1	11	64	6	8
1	1	14	50	12	17
2	1	17	41	18	26
3	1	20	40	22	32
4	1	24	33	30	44
5	1	28	29	38	55
6	2	8	50	14	20
7	2	11	41	24	35
8	2	14	32	36	52
9	2	17	29	46	67
10	2	20	28	56	82
11	2	23	28	64	93
12	2	26	29	72	105
13	3	6	67	10	14
14	3	8	58	18	26
15	3	10	53	26	38
16	3	12	50	34	49
17	3	15	47	46	67
18	3	20	43	66	96
19	3	26	41	90	132
20	3	32	40	114	167
21	3	38	39	138	202
22	3	44	38	162	237
23	4	6	50	22	32
24	4	8	44	34	49
25	4	10	40	46	67
26	4	12	38	58	85
27	4	15	35	76	111
28	4	20	33	106	155
29	4	26	31	142	208
30	4	32	30	178	261
31	4	38	29	214	313
32	4	44	28	250	366
33	4	4	50	14	20

^BI – Industrial 2 of 5 Bar Codes

Description The ^BI command is a discrete, self-checking, continuous numeric symbology. The Industrial 2 of 5 bar code has been in use the longest of the 2 of 5 family of bar codes. Of that family, the Standard 2 of 5 (^BJ) and Interleaved 2 of 5 (^B2) bar codes are also available in ZPL II.

With Industrial 2 of 5, all of the information is contained in the bars. Two bar widths are employed in this code, the wide bar measuring three times the width of the narrow bar.

- ^BI supports a print ratio of 2.0:1 to 3.0:1.
- Field data (^FD) is limited to the width (or length, if rotated) of the label.

Format ^BIo,h,f,g



Important • If additional information about the Industrial 2 of 5 bar code, go to www.aimglobal.org.

Parameters	Details
o = orientation	<p><i>Accepted Values:</i></p> <p>N = normal R = rotated 90 degrees (clockwise) I = inverted 180 degrees B = read from bottom up, 270 degrees</p> <p><i>Default Value:</i> current ^FW value</p>
h = bar code height (in dots)	<p><i>Accepted Values:</i> 1 to 32000</p> <p><i>Default Value:</i> value set by ^BY</p>
f = print interpretation line	<p><i>Accepted Values:</i></p> <p>N = no Y = yes</p> <p><i>Default Value:</i> Y</p>
g = print interpretation line above code	<p><i>Accepted Values:</i></p> <p>N = no Y = yes</p> <p><i>Default Value:</i> N</p>



Example • This is an example of an Industrial 2 of 5 bar code:

ZPL II CODE	INDUSTRIAL 2 OF 5 BAR CODE
<pre> ^XA ^FO100,100^BY3 ^BIN,150,Y,N ^FD123456^FS ^XZ </pre>	 <p style="margin-top: 5px;">123456</p>

INDUSTRIAL 2 OF 5 BAR CODE CHARACTERS									
0	1	2	3	4	5	6	7	8	9
Start/Stop (internal)									

^BJ – Standard 2 of 5 Bar Code

Description The ^BJ command is a discrete, self-checking, continuous numeric symbology.

With Standard 2 of 5, all of the information is contained in the bars. Two bar widths are employed in this code, the wide bar measuring three times the width of the narrow bar.

- ^BJ supports a print ratio of 2.0:1 to 3.0:1.
- Field data (^FD) is limited to the width (or length, if rotated) of the label.

Format ^BJo,h,f,g



Important • If additional information about the Standard 2 of 5 bar code is required, go to www.aimglobal.org.

Parameters	Details
o = orientation	<p><i>Accepted Values:</i></p> <p>N = normal R = rotated 90 degrees (clockwise) I = inverted 180 degrees B = read from bottom up, 270 degrees</p> <p><i>Default Value:</i> current ^FW value</p>
h = bar code height (in dots)	<p><i>Accepted Values:</i> 1 to 32000</p> <p><i>Default Value:</i> value set by ^BY</p>
f = print interpretation line	<p><i>Accepted Values:</i></p> <p>N = no Y = yes</p> <p><i>Default Value:</i> Y</p>
g = print interpretation line above code	<p><i>Accepted Values:</i></p> <p>N = no Y = yes</p> <p><i>Default Value:</i> N</p>

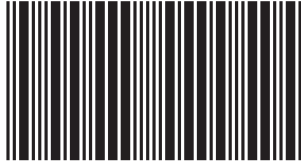

Example • This is an example of a Standard 2 of 5 bar code:

ZPL II CODE	STANDARD 2 OF 5 BAR CODE
<pre> ^XA ^FO100,100^BY3 ^BJN,150,Y,N ^FD123456^FS ^XZ </pre>	 <p>123456</p>

STANDARD 2 OF 5 BAR CODE CHARACTERS									
0	1	2	3	4	5	6	7	8	9
Start/Stop (automatic)									

^BK – ANSI Codabar Bar Code

Description The ANSI Codabar bar code is used in a variety of information processing applications such as libraries, the medical industry, and overnight package delivery companies. This bar code is also known as USD-4 code, NW-7, and 2 of 7 code. It was originally developed for retail price labeling.

Each character in this code is composed of seven elements: four bars and three spaces. Codabar bar codes use two character sets, numeric and control (start and stop) characters.

- ^BK supports a print ratio of 2.0:1 to 3.0:1.
- Field data (^FD) is limited to the width (or length, if rotated) of the label.

Format ^BKo,e,h,f,g,k,l



Important • If additional information about the ANSI Codabar bar code is required, go to www.aimglobal.org.

Parameters	Details
o = orientation	<p><i>Accepted Values:</i></p> <ul style="list-style-type: none"> N = normal R = rotated 90 degrees (clockwise) I = inverted 180 degrees B = read from bottom up, 270 degrees <p><i>Default Value:</i> current ^FW value</p>
e = check digit	<p><i>Fixed Value:</i> N</p>
h = bar code height (in dots)	<p><i>Accepted Values:</i> 1 to 32000</p> <p><i>Default Value:</i> value set by ^BY</p>
f = print interpretation line	<p><i>Accepted Values:</i></p> <ul style="list-style-type: none"> N = no Y = yes <p><i>Default Value:</i> Y</p>
g = print interpretation line above code	<p><i>Accepted Values:</i></p> <ul style="list-style-type: none"> N = no Y = yes <p><i>Default Value:</i> N</p>
k = designates a start character	<p><i>Accepted Values:</i> A, B, C, D</p> <p><i>Default Value:</i> A</p>
l = designates stop character	<p><i>Accepted Values:</i> A, B, C, D</p> <p><i>Default Value:</i> A</p>



Example • This is an example of an ANSI Codabar bar code:

ZPL II CODE	ANSI CODABAR BAR CODE								
<pre> ^XA ^FO100,100^BY3 ^BKN,N,150,Y,N,A,A ^FD123456^FS ^XZ </pre>	 <p>A123456A</p>								
ANSI CODABAR BAR CODE CHARACTERS									
0	1	2	3	4	5	6	7	8	9
Control Characters									
- : . \$ / +									
Start/Stop Characters									
A B C D									

^BL – LOGMARS Bar Code

Description The ^BL command is a special application of Code 39 used by the Department of Defense. LOGMARS is an acronym for Logistics Applications of Automated Marking and Reading Symbols.

- ^BL supports a print ratio of 2.0:1 to 3.0:1.
- Field data (^FD) is limited to the width (or length, if rotated) of the label. Lowercase letters in the ^FD string are converted to the supported uppercase LOGMARS characters.

Format ^BL o,h,g



Important • If additional information about the LOGMARS bar code is required, go to www.aimglobal.org.

Parameters	Details
o = orientation	<p><i>Accepted Values:</i></p> <ul style="list-style-type: none"> N = normal R = rotated 90 degrees (clockwise) I = inverted 180 degrees B = read from bottom up, 270 degrees <p><i>Default Value:</i> current ^FW value</p>
h = bar code height (in dots)	<p><i>Accepted Values:</i> 1 to 32000</p> <p><i>Default Value:</i> value set by ^BY</p>
g = print interpretation line above code	<p><i>Accepted Values:</i></p> <ul style="list-style-type: none"> N = no Y = yes <p><i>Default Value:</i> N</p>



Example • This is an example of a LOGMARS bar code:

ZPL II CODE	LOGMARS BAR CODE																																																																																									
<pre> ^XA ^FO100,75^BY3 ^BLN,100,N ^FD12AB^FS ^XZ </pre>	 <p style="margin-top: 5px;">12AB0</p>																																																																																									
LOGMARS BAR CODE CHARACTERS																																																																																										
<table style="width: 100%; border-collapse: collapse;"> <tr> <td style="width: 10%;"></td> <td style="width: 10%;">0</td> <td style="width: 10%;">1</td> <td style="width: 10%;">2</td> <td style="width: 10%;">3</td> <td style="width: 10%;">4</td> <td style="width: 10%;">5</td> <td style="width: 10%;">6</td> <td style="width: 10%;">7</td> <td style="width: 10%;">8</td> <td style="width: 10%;">9</td> </tr> <tr> <td>A</td><td>B</td><td>C</td><td>D</td><td>E</td><td>F</td><td>G</td><td>H</td><td>I</td><td>J</td><td>K</td><td>L</td><td>M</td><td>N</td><td>O</td><td>P</td><td>Q</td><td>R</td><td>S</td><td>T</td><td>U</td><td>V</td><td>W</td><td>X</td><td>Y</td><td>Z</td> </tr> <tr> <td></td><td></td><td></td><td></td><td></td><td>-</td><td>.</td><td></td><td></td><td></td><td>\$</td><td>/</td><td></td><td></td><td></td><td>+</td><td></td><td></td><td></td><td></td><td></td><td></td><td></td><td></td><td></td><td>%</td> </tr> <tr> <td></td><td></td><td></td><td></td><td></td><td></td><td></td><td></td><td></td><td></td><td></td><td></td><td></td><td></td><td></td><td></td><td></td><td></td><td></td><td></td><td></td><td></td><td></td><td></td><td></td><td>SPACE</td> </tr> </table>			0	1	2	3	4	5	6	7	8	9	A	B	C	D	E	F	G	H	I	J	K	L	M	N	O	P	Q	R	S	T	U	V	W	X	Y	Z						-	.				\$	/				+										%																										SPACE
	0	1	2	3	4	5	6	7	8	9																																																																																
A	B	C	D	E	F	G	H	I	J	K	L	M	N	O	P	Q	R	S	T	U	V	W	X	Y	Z																																																																	
					-	.				\$	/				+										%																																																																	
																									SPACE																																																																	

Comments The LOGMARS bar code produces a *mandatory* check digit using Mod 43 calculations. For further information on the Mod 43 check digit, see [Mod 10 Check Digit on page 1224](#).

^BM – MSI Bar Code

Description The ^BM command is a pulse-width modulated, continuous, non-self-checking symbology. It is a variant of the Plessey bar code (^BP).

Each character in the MSI bar code is composed of eight elements: four bars and four adjacent spaces.

- ^BM supports a print ratio of 2.0:1 to 3.0:1.
- For the bar code to be valid, field data (^FD) is limited to 1 to 14 digits when parameter e is B, C, or D. ^FD is limited to 1 to 13 digits when parameter e is A, plus a quiet zone.

Format ^BMo,e,h,f,g,e2



Important • If additional information about the MSI bar code is required, go to www.aimglobal.org.

Parameters	Details
o = orientation	<p><i>Accepted Values:</i></p> <p>N = normal R = rotated 90 degrees (clockwise) I = inverted 180 degrees B = read from bottom up, 270 degrees</p> <p><i>Default Value:</i> current ^FW value</p>
e = check digit selection	<p><i>Accepted Values:</i></p> <p>A = no check digits B = 1 Mod 10 C = 2 Mod 10 D = 1 Mod 11 and 1 Mod 10</p> <p><i>Default Value:</i> B</p>
h = bar code height (in dots)	<p><i>Accepted Values:</i> 1 to 32000</p> <p><i>Default Value:</i> value set by ^BY</p>
f = print interpretation line	<p><i>Accepted Values:</i></p> <p>N = no Y = yes</p> <p><i>Default Value:</i> Y</p>
g = print interpretation line above code	<p><i>Accepted Values:</i></p> <p>N = no Y = yes</p> <p><i>Default Value:</i> N</p>

Parameters	Details
e2 = inserts check digit into the interpretation line	<p><i>Accepted Values:</i></p> <p>N = no</p> <p>Y = yes</p> <p><i>Default Value: N</i></p>

➔ **Example** • This is an example of a MSI bar code:

ZPL II CODE	MSI BAR CODE							
<pre> ^XA ^FO100,100^BY3 ^BMN,B,100,Y,N,N ^FD123456^FS ^XZ </pre>	 <p>123456</p>							
MSI BAR CODE CHARACTERS								
1	2	3	4	5	6	7	8	9

^B0 – Aztec Bar Code Parameters

Description The ^B0 command creates a two-dimensional matrix symbology made up of square modules arranged around a bulls-eye pattern at the center.



Note • The Aztec bar code works with firmware version V60.13.0.11A and V50.13.2 or later.

Format ^B0a,b,c,d,e,f,g

Parameters	Details
a = orientation	<p><i>Accepted Values:</i></p> <ul style="list-style-type: none"> N = normal R = rotated I = inverted 180 degrees B = read from bottom up, 270 degrees <p><i>Default Value:</i> current ^FW value</p>
b = magnification factor	<p><i>Accepted Values:</i> 1 to 10</p> <p><i>Default Value:</i></p> <ul style="list-style-type: none"> 1 on 150 dpi printers 2 on 200 dpi printers 3 on 300 dpi printers 6 on 600 dpi printers
c = extended channel interpretation code indicator	<p><i>Accepted Values:</i></p> <ul style="list-style-type: none"> Y = if data contains ECICs N = if data does not contain ECICs. <p><i>Default Value:</i> N</p>
d = error control and symbol size/type indicator	<p><i>Accepted Values:</i></p> <ul style="list-style-type: none"> 0 = default error correction level 01 to 99 = error correction percentage (minimum) 101 to 104 = 1 to 4-layer compact symbol 201 to 232 = 1 to 32-layer full-range symbol 300 = a simple Aztec “Rune” <p><i>Default Value:</i> 0</p>
e = menu symbol indicator	<p><i>Accepted Values:</i></p> <ul style="list-style-type: none"> Y = if this symbol is to be a menu (bar code reader initialization) symbol N = if it is not a menu symbol <p><i>Default Value:</i> N</p>
f = number of symbols for structured append	<p><i>Accepted Values:</i> 1 through 26</p> <p><i>Default Value:</i> 1</p>
g = optional ID field for structured append	<p>The ID field is a text string with 24-character maximum</p> <p><i>Default Value:</i> no ID</p>



Example • This is an example of the `^B0` command:

ZPL II CODE	GENERATED LABEL
<pre data-bbox="428 317 894 573">^XA ^B0R,7,N,0,N,1,0 ^FD 7. This is testing label 7^FS ^XZ</pre>	

^BP – Plessey Bar Code

Description The ^BP command is a pulse-width modulated, continuous, non-self-checking symbology.

Each character in the Plessey bar code is composed of eight elements: four bars and four adjacent spaces.

- ^BP supports a print ratio of 2.0:1 to 3.0:1.
- Field data (^FD) is limited to the width (or length, if rotated) of the label.

Format ^BPo,e,h,f,g



Important • If additional information about the Plessey bar code is required, go to www.aimglobal.org.

Parameters	Details
o = orientation	<p><i>Accepted Values:</i></p> <p>N = normal R = rotated 90 degrees (clockwise) I = inverted 180 degrees B = read from bottom up, 270 degrees</p> <p><i>Default Value:</i> current ^FW value</p>
e = print check digit	<p><i>Accepted Values:</i></p> <p>N = no Y = yes</p> <p><i>Default Value:</i> N</p>
h = bar code height (in dots)	<p><i>Accepted Values:</i></p> <p>N = no Y = yes</p> <p><i>Default Value:</i> N</p>
f = print interpretation line	<p><i>Accepted Values:</i></p> <p>N = no Y = yes</p> <p><i>Default Value:</i> Y</p>
g = print interpretation line above code	<p><i>Accepted Values:</i></p> <p>N = no Y = yes</p> <p><i>Default Value:</i> N</p>



Example • This is an example of a Plessey bar code:

ZPL II CODE	PLESSEY BAR CODE
<pre> ^XA ^FO100,100^BY3 ^BPN,N,100,Y,N ^FD12345^FS ^XZ </pre>	 <p>12345</p>

PLESSEY BAR CODE CHARACTERS									
0	1	2	3	4	5	6	7	8	9
			A	B	C	D	E	F	

^BQ – QR Code Bar Code

Description The ^BQ command produces a matrix symbology consisting of an array of nominally square modules arranged in an overall square pattern. A unique pattern at three of the symbol's four corners assists in determining bar code size, position, and inclination.

A wide range of symbol sizes is possible, along with four levels of error correction. User-specified module dimensions provide a wide variety of symbol production techniques.

QR Code Model 1 is the original specification, while QR Code Model 2 is an enhanced form of the symbology. Model 2 provides additional features and can be automatically differentiated from Model 1.

Model 2 is the recommended model and should normally be used.

This bar code is printed using field data specified in a subsequent ^FD string.

Encodable character sets include numeric data, alphanumeric data, 8-bit byte data, and Kanji characters.

Format ^BQa,b,c,d,e



Important • If additional information about the QR Code bar code is required, go to www.aimglobal.org.

Parameters	Details
a = field orientation	<i>Fixed Value:</i> normal (^FW has no effect on rotation)
b = model	<i>Accepted Values:</i> 1 (original) and 2 (enhanced – recommended) <i>Default Value:</i> 2
c = magnification factor	<i>Accepted Values:</i> 1 to 10 <i>Default Value:</i> 1 on 150 dpi printers 2 on 200 dpi printers 3 on 300 dpi printers 6 on 600 dpi printers
d = error correction	<i>Accepted Values:</i> H = ultra-high reliability level Q = high reliability level M = standard level L = high density level <i>Default Value:</i> Q = if empty M = invalid values
e = mask value	<i>Accepted Values:</i> 0 - 7 <i>Default Value:</i> 7



Example 1 • This is an example of a QR Code bar code:

ZPL II CODE	QR CODE BAR CODE
<pre>^XA ^FO100,100 ^BQN,2,10 ^FDMM,AAC-42^FS ^XZ</pre>	

On the pages that follow are specific commands for formatting the ^BQ command with the ^FD statements that contain the information to be coded.

Considerations for ^FD When Using the QR Code:

QR Switches (formatted into the ^FD field data)

mixed mode <D>

D = allows mixing of different types of character modes in one code.

code No. <01 16>

Value = subtracted from the Nth number of the divided code (must be two digits).

No. of divisions <02 16>

Number of divisions (must be two digits).

parity data <1 byte>

Parity data value is obtained by calculating at the input data (the original input data before divided byte-by-byte through the EX-OR operation).

error correction level <H, Q, M, L>

H = ultra-high reliability level

Q = high reliability level

M = standard level (default)

L = high density level

character Mode <N, A, B, K>

N = numeric

A = alphanumeric

Bxxxx = 8-bit byte mode. This handles the 8-bit Latin/Kana character set in accordance with JIS X 0201 (character values 0x00 to 0xFF).

xxxx = number of data characters is represented by two bytes of BCD code.

K = Kanji — handles only Kanji characters in accordance with the Shift JIS system based on JIS X 0208. This means that all parameters after the character mode K should be 16-bit characters. If there are any 8-bit characters (such as ASCII code), an error occurs.

data character string <Data>

Follows character mode or it is the last switch in the ^FD statement.

data input <A, M>

A = Automatic Input (default). Data character string JIS8 unit, Shift JIS. When the input mode is Automatic Input, the binary codes of 0x80 to 0x9F and 0xE0 to 0xFF cannot be set.

M = Manual Input

Two types of data input mode exist: Automatic (A) and Manual (M). If A is specified, the character mode does not need to be specified. If M is specified, the character mode must be specified.

^FD Field Data (Normal Mode)

Automatic Data Input (A) with Switches

^FD

<error correction level>A,

<data character string>

^FS

➔ **Example 1 • QR Code, normal mode with automatic data input.**

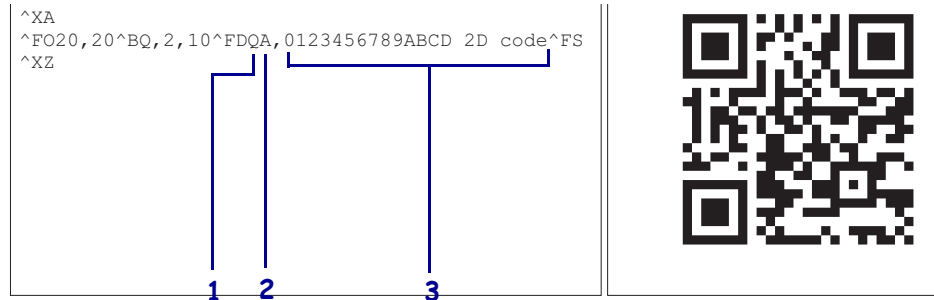

1	Q = error correction level
2	A, = automatic setting
3	data string character

Manual Data Input (M) with Switches

^FD

<error correction level>M,

<character mode><data character string>

^FS

➔ **Example 1 • QR Code, normal mode with manual data input:**

ZPL II CODE	GENERATED LABEL
<pre> ^XA ^FO20,20^BQ,2,10 ^FDHM,N123456789012345^FS ^XZ </pre>	

1
2
3
4

1	H = error correction level (ultra-high reliability level)
2	M, = input mode (manual input)
3	N = character mode (numeric data)
4	data character string

➔ **Example 2 • QR Code, normal mode with standard reliability and manual data input:**

ZPL II CODE	GENERATED LABEL
<pre> ^XA ^FO20,20^BQ,2,10^FDM, AAC-42^FS ^XZ </pre>	

1
2
3
4

1	M = error correction level (standard-high reliability level)
2	M, = manual input
3	A = alphanumeric data
4	AC-42 = data character string

^FD Field Data (Mixed Mode – requires more switches)**Automatic Data Input (A) with Switches**

```
^FD
<D><code No.> <No. of divisions> <parity data>,
<error correction level> A,
<data character string>,
<data character string>,
< : >,
<data character string n**>
^FS
```

Manual Data Input (M) with Switches

```
^FD
<code No.> <No. of divisions> <parity data>,
<error correction level> M,
<character mode 1> <data character string 1>,
<character mode 2> <data character string 2>,
< : > < : >,
<character mode n> <data character string n**>
^FS
```

n** up to 200 in mixed mode



Example • QR Code, mixed mode with manual data input:

ZPL II CODE	GENERATED LABEL
<pre> ^XA ^FO,20,20^BQ,2,10 ^FDD03048F,LM,N0123456789,A12AABB,B0006qrcode^FS ^XZ </pre>	

<mixed mode identifier>	D	(mixed)
<code No.>	M	(code number)
<No. of divisions>	D	(divisions)
<parity data>	M	(0x0C)
	.	
<error correction level>	L	(high-density level)
<input mode>	M	(manual input)
	.	
<character mode>	N	(numeric data)
<data character string>		0123456789
	.	
<character mode>	A	(alphanumeric data)
<data character string>		12AABB
	.	
<character mode>	B	(8-bit byte data)
	0006	(number of bytes)
<data character string>		qrcode



Example • This is an example of QR Code, mixed mode with automatic data input:

```

^XA
^F020,20^BQ,2,10
^FDD03040C,LA,012345678912AABBqrancode^FS
^XZ
    
```

<mixed mode identifier>	D	D (mixed)
<code No.>	M	03 (code number)
<No. of divisions>	D	04 (divisions)
<parity data>	M	0C (0x0C)
<error correction level>	L	L (high-density level)
<input mode>	A	A (automatic input)
<data character string>		012345678912AABBqrancode



For proper functionality, when encoding Kanji characters in ^CI28-30 (Unicode) be sure the JIS.DAT table is loaded on the printer and specified.



Example • This is a Unicode example:

ZPL II CODE	GENERATED LABEL
<pre> ^XA^SEE:JIS.DAT^CI28 ^FO20,20^BQ,2,10^FDLM,KE月^FS ^XZ </pre>	

^BR – GS1 Databar

(formerly Reduced Space Symbology)

Description The ^BR command is bar code types for space-constrained identification from EAN International and the Uniform Code Council, Inc.

Format ^BRa,b,c,d,e,f

Parameters	Details
a = orientation	<p><i>Accepted Values:</i></p> <ul style="list-style-type: none"> N = Normal R = Rotated I = Inverted B = Bottom-up <p><i>Default Value:</i> R</p>
b = symbology type in the GS1 DataBar family	<p><i>Accepted Values:</i></p> <ul style="list-style-type: none"> 1 = GS1 DataBar Omnidirectional 2 = GS1 DataBar Truncated 3 = GS1 DataBar Stacked 4 = GS1 DataBar Stacked Omnidirectional 5 = GS1 DataBar Limited 6 = GS1 DataBar Expanded 7 = UPC-A 8 = UPC-E 9 = EAN-13 10 = EAN-8 11 = UCC/EAN-128 and CC-A/B 12 = UCC/EAN-128 and CC-C <p><i>Default Value:</i> 1</p>
c = magnification factor	<p><i>Accepted Values:</i> 1 to 10</p> <p><i>Default Value:</i></p> <ul style="list-style-type: none"> 24 dot = 6, 12 dot is 3, 8 dot and lower is 2 12 dot = 6, > 8 dot is 3, 8 dot and less is 2
d = separator height	<p><i>Accepted Values:</i> 1 or 2</p> <p><i>Default Value:</i> 1</p>
e = bar code height	<p>The bar code height only affects the linear portion of the bar code. Only UCC/EAN and CC-A/B/C.</p> <p><i>Accepted Values:</i> 1 to 32000 dots</p> <p><i>Default Value:</i> 25</p>
f = the segment width (GS1 DataBar Expanded only)	<p><i>Accepted Values:</i> 2 to 22, even numbers only, in segments per line</p> <p><i>Default Value:</i> 22</p>

➔ **Example 1** • This is an example of Symbology Type 7 - UPC-A:

ZPL II CODE	GENERATED LABEL
<pre> ^XA ^FO10,10^BRN,7,5,2,100 ^FD12345678901 this is composite info^FS ^XZ </pre>	

➔ **Example 2** • This is an example of Symbology Type 1 - GS1 DataBar Omnidirectional:

ZPL II CODE	GENERATED LABEL
<pre> ^XA ^FO10,10^BRN,1,5,2,100 ^FD12345678901 this is composite info^FS ^XZ </pre>	

^BS – UPC/EAN Extensions

Description The ^BS command is the two-digit and five-digit add-on used primarily by publishers to create bar codes for ISBNs (International Standard Book Numbers). These extensions are handled as separate bar codes.

The ^BS command is designed to be used with the UPC-A bar code (^BU) and the UPC-E bar code (^B9).

- ^BS supports a fixed print ratio.
- Field data (^FD) is limited to exactly two or five characters. ZPL II automatically truncates or pads on the left with zeros to achieve the required number of characters.

Format ^BS_{o,h,f,g}



Important • If additional information about the UPC/EAN bar code is required, go to www.aimglobal.org.

Parameters	Details
o = orientation	<p><i>Accepted Values:</i></p> <ul style="list-style-type: none"> N = normal R = rotated 90 degrees (clockwise) I = inverted 180 degrees B = read from bottom up, 270 degrees <p><i>Default Value:</i> current ^FW value</p>
h = bar code height (in dots)	<p><i>Accepted Values:</i> 1 to 32000</p> <p><i>Default Value:</i> value set by ^BY</p>
f = print interpretation line	<p><i>Accepted Values:</i></p> <ul style="list-style-type: none"> N = no Y = yes <p><i>Default Value:</i> Y</p>
g = print interpretation line above code	<p><i>Accepted Values:</i></p> <ul style="list-style-type: none"> N = no Y = yes <p><i>Default Value:</i> Y</p>



Example 1 • This is an example of a UPC/EAN Two-digit bar code:

ZPL II CODE	UPC/EAN 2-DIGIT BAR CODE
<pre> ^XA ^FO100,100^BY3 ^BSN,100,Y,N ^FD12^FS ^XZ </pre>	 12
UPC/EAN 2-DIGIT BAR CODE CHARACTERS	
0 1 2 3 4 5 6 7 8 9	



Example 2 • This is an example of a UPC/EAN Five-digit bar code:

ZPL II CODE	UPC/EAN 5-DIGIT BAR CODE
<pre> ^XA ^FO100,100^BY3 ^BSN,100,Y,N ^FD12345^FS ^XZ </pre>	 12345
UPC/EAN 5-DIGIT BAR CODE CHARACTERS	
0 1 2 3 4 5 6 7 8 9	

Care should be taken in positioning the UPC/EAN extension with respect to the UPC-A or UPC-E code to ensure the resulting composite code is within the UPC specification.

For UPC codes, with a module width of 2 (default), the field origin offsets for the extension are:

→ **Example 3** • This is an example of a UPC-A:

	Supplement Origin X - Offset	Adjustment Y - Offset
<i>Normal</i>	209 Dots	21 Dots
<i>Rotated</i>	0	209 Dots

This is an example of a UPC-E:

	Supplement Origin X - Offset	Adjustment Y - Offset
<i>Normal</i>	122 Dots	21 Dots
<i>Rotated</i>	0	122 Dots

Additionally, the bar code height for the extension should be 27 dots (0.135 inches) shorter than that of the primary code. A primary UPC code height of 183 dots (0.900 inches) requires an extension height of 155 dots (0.765 inches).

→ **Example 4** • This example illustrates how to create a normal UPC-A bar code for the value 7000002198 with an extension equal to 04414:

ZPL II CODE	UPC-A BAR CODE WITH EXTENSION
<pre> ^XA ^FO100,100^BY3 ^BUN,137 ^FD07000002198^FS ^FO400,121 ^BSN,117 ^FD04414^FS ^XZ </pre>	

^BT – TLC39 Bar Code

Description The ^BT bar code is the standard for the TCIF can tag telecommunications equipment.

The TCIF CLEI code, which is the MicroPDF417 bar code, is always four columns. The firmware must determine what mode to use based on the number of characters to be encoded.

Format ^BT $o,w1,r1,h1,w2,h2$

Parameters	Details
o = orientation	<p><i>Accepted Values:</i></p> <ul style="list-style-type: none"> N = normal R = rotated I = inverted B = bottom up
$w1$ = width of the Code 39 bar code	<p><i>Accepted Value (in dots): 1 to 10</i></p> <p><i>Default Value (600 dpi printers): 4</i></p> <p><i>Default Value (200- and 300 dpi printer): 2</i></p>
$r1$ = wide to narrow bar width ratio the Code 39 bar code	<p><i>Accepted Values: 2.0 to 3.0(increments of 0.1)</i></p> <p><i>Default Value: 2.0</i></p>
$h1$ = height of the Code 39 bar code	<p><i>Accepted Values (in dots): 1 to 9999</i></p> <p><i>Default Value (600 dpi printer): 120</i></p> <p><i>Default Value (300 dpi printer): 60</i></p> <p><i>Default Value (200 dpi printer): 40</i></p>
$h2$ = row height of the MicroPDF417 bar code	<p><i>Accepted Values (in dots): 1 to 255</i></p> <p><i>Default Value (600 dpi printer): 8</i></p> <p><i>Default Value (200- and 300 dpi printers): 4</i></p>
$w2$ = narrow bar width of the MicroPDF417 bar code	<p><i>Accepted Values (in dots): 1 to 10</i></p> <p><i>Default Value (600 dpi printer): 4</i></p> <p><i>Default Value (200- and 300 dpi printers): 2</i></p>



Example • TLC39 Bar Code

This is an example on how to print TLC39 bar code. The callouts identify the key components and are followed by a detailed description below:

Use the command defaults to get results that are in compliance with TCIF industry standards; regardless of printhead density.

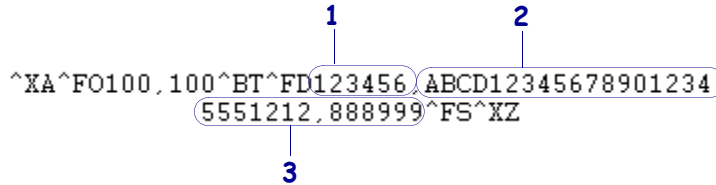

1	<p>ECI Number. If the seventh character is not a comma, only Code 39 prints. This means if more than 6 digits are present, Code 39 prints for the first six digits (and no Micro-PDF symbol is printed).</p> <ul style="list-style-type: none"> • Must be 6 digits. • Firmware generates invalid character error if the firmware sees anything but 6 digits. • This number is not padded.
2	<p>Serial number. The serial number can contain up to 25 characters and is variable length. The serial number is stored in the Micro-PDF symbol. If a comma follows the serial number, then additional data is used below.</p> <ul style="list-style-type: none"> • If present, must be alphanumeric (letters and numbers, no punctuation). <p>This value is used if a comma follows the ECI number.</p>
3	<p>Additional data. If present, it is used for things such as a country code. Data cannot exceed 150 bytes. This includes serial number commas.</p> <ul style="list-style-type: none"> • Additional data is stored in the Micro-PDF symbol and appended after the serial number. A comma must exist between each maximum of 25 characters in the additional fields. • Additional data fields can contain up to 25 alphanumeric characters per field. <p>The result is:</p>

ZPL II CODE
<pre>^XA^FO100, 100^BT^FD123456, ABCd12345678901234, 5551212, 88899 ^FS^XZ</pre>



^BU – UPC-A Bar Code

Description The ^BU command produces a fixed length, numeric symbology. It is primarily used in the retail industry for labeling packages. The UPC-A bar code has 11 data characters. The 6 dot/mm, 12 dot/mm, and 24 dot/mm printheads produce the UPC-A bar code (UPC/EAN symbologies) at 100 percent size. However, an 8 dot/mm printhead produces the UPC/EAN symbologies at a magnification factor of 77 percent.

- ^BU supports a fixed print ratio.
- Field data (^FD) is limited to exactly 11 characters. ZPL II automatically truncates or pads on the left with zeros to achieve required number of characters.

Format ^BUo,h,f,g,e



Important • If additional information about the UPC-A bar code is required, go to www.aimglobal.org.

Parameters	Details
o = orientation	<p><i>Accepted Values:</i></p> <p>N = normal R = rotated 90 degrees (clockwise) I = inverted 180 degrees B = read from bottom up, 270 degrees</p> <p><i>Default Value:</i> current ^FW value</p>
h = bar code height (in dots)	<p><i>Accepted Values:</i> 1 to 9999</p> <p><i>Default Value:</i> value set by ^BY</p>
f = print interpretation line	<p><i>Accepted Values:</i></p> <p>N = no Y = yes</p> <p><i>Default Value:</i> Y</p>
g = print interpretation line above code	<p><i>Accepted Values:</i></p> <p>N = no Y = yes</p> <p><i>Default Value:</i> N</p>
e = print check digit	<p><i>Accepted Values:</i></p> <p>N = no Y = yes</p> <p><i>Default Value:</i> Y</p>

The font style of the interpretation line depends on the modulus (width of narrow bar) selected in ^BY:



Note • Zero is not allowed.

- **6 dot/mm printer:** a modulus of 2 dots or greater prints with an OCR-B interpretation line; a modulus of 1 dot prints font A.
- **8 dot/mm printer:** a modulus of 3 dots or greater prints with an OCR-B interpretation line; a modulus of 1 or 2 dots prints font A.
- **12 dot/mm printer:** a modulus of 5 dots or greater prints with an OCR-B interpretation line; a modulus of 1, 2, 3, or 4 dots prints font A.
- **24 dot/mm printer:** a modulus of 9 dots or greater prints with an OCR-B interpretation line; a modulus of 1 to 8 dots prints font A.



Example • This is an example of a UPC-A bar code with extension:

ZPL II CODE	UPC-A BAR CODE WITH EXTENSION
<pre> ^XA ^FO100,100^BY3 ^BUN,137 ^FD07000002198^FS ^FO400,121 ^BSN,117 ^FD04414^FS ^XZ </pre>	

Comments The UPC-A bar code uses the Mod 10 check digit scheme for error checking. For further information on Mod 10, see [Mod 10 Check Digit on page 1224](#).

^BX – Data Matrix Bar Code

Description The ^BX command creates a two-dimensional matrix symbology made up of square modules arranged within a perimeter finder pattern.

Format ^BXo,h,s,c,r,f,g,a

Parameters	Details
o = orientation	<p><i>Accepted Values:</i></p> <ul style="list-style-type: none"> N = normal R = rotated 90 degrees (clockwise) I = inverted 180 degrees B = read from bottom up, 270 degrees <p><i>Default Value:</i> current ^FW value</p>
h = dimensional height of individual symbol elements	<p><i>Accepted Values:</i> 1 to the width of the label</p> <p>The individual elements are square — this parameter specifies both module and row height. If this parameter is zero (or not given), the h parameter (bar height) in ^BY is used as the approximate symbol height.</p>
s = quality level	<p><i>Accepted Values:</i> 0, 50, 80, 100, 140, 200</p> <p><i>Default Value:</i> 0</p> <p><i>Quality</i> refers to the amount of data that is added to the symbol for error correction. The AIM specification refers to it as the ECC value. ECC 50, ECC 80, ECC 100, and ECC 140 use convolution encoding; ECC 200 uses Reed-Solomon encoding. For new applications, ECC 200 is recommended. ECC 000-140 should be used only in closed applications where a single party controls both the production and reading of the symbols and is responsible for overall system performance.</p>
c = columns to encode	<p><i>Accepted Values:</i> 9 to 49</p> <p>Odd values only for quality 0 to 140 (10 to 144); even values only for quality 200.</p> <p>Odd values only for quality 0 to 140 (10 to 144); even values only for quality 200. The number of rows and columns in the symbol is automatically determined. You might want to force the number of rows and columns to a larger value to achieve uniform symbol size. In the current implementation, quality 0 to 140 symbols are square, so the larger of the rows or columns supplied are used to force a symbol to that size. If you attempt to force the data into too small of a symbol, no symbol is printed. If a value greater than 49 is entered, the rows or columns value is set to zero and the size is determined normally. If an even value is entered, it generates INVALID-P (invalid parameter). If a value less than 9 but not 0, or if the data is too large for the forced size, no symbol prints; if ^CV is active, INVALID-L prints.</p>
r = rows to encode	<p><i>Accepted Values:</i> 9 to 49</p>

Parameters	Details
<p>f = format ID (0 to 6) — not used with quality set at 200</p>	<p><i>Accepted Values:</i></p> <ul style="list-style-type: none"> 1 = field data is numeric + space (0..9,") – No \&" 2 = field data is uppercase alphanumeric + space (A..Z,") – No \&" 3 = field data is uppercase alphanumeric + space, period, comma, dash, and slash (0..9,A..Z,“-/”) 4 = field data is upper-case alphanumeric + space (0..9,A..Z,") – no \&" 5 = field data is full 128 ASCII 7-bit set 6 = field data is full 256 ISO 8-bit set <p><i>Default Value:</i> 6</p>
<p>g = escape sequence control character</p>	<p><i>Accepted Values:</i> any character</p> <p><i>Default Value:</i> ~ (tilde)</p> <p>This parameter is used only if quality 200 is specified. It is the escape character for embedding special control sequences within the field data.</p> <p>Important • A value must always be specified when using the escape sequence control character. If no value is entered, the command is ignored.</p> <p>The g parameter will continue to be underscore (_) for anyone with firmware version: V60.13.0.12, V60.13.0.12Z, V60.13.0.12B, V60.13.0.12ZB, or later.</p>
<p>a = aspect ratio</p> <div style="border: 1px solid black; padding: 2px; width: fit-content; margin: 10px 0;">.16†</div> <p>The a parameter is only supported in V60.16.5Z and V53.16.5Z or later.</p>	<p><i>Accepted Values:</i></p> <ul style="list-style-type: none"> 1 = square 2 = rectangular <p><i>Default Value:</i> 1</p>

Table 10 • Maximum Field Sizes for ^BX

ECC LEVEL	ID = 1	ID = 2	ID = 3	ID = 4	ID = 5	ID = 6
0	596	452	394	413	310	271
50	457	333	291	305	228	200
80	402	293	256	268	201	176
100	300	218	190	200	150	131
140	144	105	91	96	72	63

Maximum Field Sizes

➔ **Example 1** • This is an example of a square Data Matrix bar code:

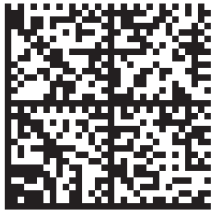
ZPL II CODE	DATA MATRIX BAR CODE
<pre> ^XA ^FO100,100 ^BXN,10,200 ^FDZEBRA TECHNOLOGIES CORPORATION 333 CORPORATE WOODS PARKWAY VERNON HILLS, IL 60061-3109^FS ^XZ </pre>	

➔ **Example 2** • This is an example of a rectangle Data Matrix bar code:

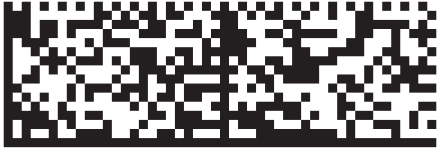
ZPL II CODE	DATA MATRIX BAR CODE
<pre> ^XA ^FO100,100 ^BXN,10,200,,,,,2 ^FDZEBRA TECHNOLOGIES CORPORATION 333 CORPORATE WOODS PARKWAY ^FS ^XZ </pre>	

Effects of ^BY on ^BX

w = **module width** (no effect)

r = **ratio** (no effect)

h = **height of symbol**

If the dimensions of individual symbol elements are not specified in the ^BY command, the height of symbol value is divided by the required rows/columns, rounded, limited to a minimum value of one, and used as the dimensions of individual symbol elements.

Field Data (^FD) for ^BX

Quality 000 to 140

- The \& and || can be used to insert carriage returns, line feeds, and the backslash, similar to the PDF417. Other characters in the control character range can be inserted only by using ^FH. Field data is limited to 596 characters for quality 0 to 140. Excess field data causes no symbol to print; if ^CV is active, INVALID-L prints. The field data must correspond to a user-specified format ID or no symbol prints; if ^CV is active, INVALID-C prints.
- The maximum field sizes for quality 0 to 140 symbols are shown in the table in the g parameter.

Quality 200

- If more than 3072 bytes are supplied as field data, it is truncated to 3072 bytes. This limits the maximum size of a numeric Data Matrix symbol to less than the 3116 numeric characters that the specification would allow. The maximum alphanumeric capacity is 2335 and the maximum 8-bit byte capacity is 1556.
- If ^FH is used, field hexadecimal processing takes place before the escape sequence processing described below.
- The underscore is the default escape sequence control character for quality 200 field data. A different escape sequence control character can be selected by using parameter g in the ^BX command.

The information that follows applies to firmware version: V60.13.0.12, V60.13.0.12Z, V60.13.0.12B, V60.13.0.12ZB, or later. The input string escape sequences can be embedded in quality 200 field data using the ASCII 95 underscore character (_) or the character entered in parameter g:

- `_X` is the shift character for control characters (e.g., `_@=NUL, _G=BEL, _0 is PAD`)
- `_1` to `_3` for FNC characters 1 to 3 (explicit FNC4, upper shift, is not allowed)
- FNC2 (Structured Append) must be followed by nine digits, composed of three-digit numbers with values between 1 and 254, that represent the symbol sequence and file identifier (for example, symbol 3 of 7 with file ID 1001 is represented by `_2214001001`)
- `5NNN` is code page NNN where NNN is a three-digit code page value (for example, Code Page 9 is represented by `_5009`)
- `_dNNN` creates ASCII decimal value NNN for a code word (must be three digits)
- `_` in data is encoded by `__` (two underscores)

The information that follows applies to all other versions of firmware. The input string escape sequences can be embedded in quality 200 field data using the ASCII 7E tilde character (~) or the character entered in parameter g:

- `~X` is the shift character for control characters (e.g., `~@=NUL, ~G=BEL, ~0 is PAD`)
- `~1` to `~3` for FNC characters 1 to 3 (explicit FNC4, upper shift, is not allowed)
- FNC2 (Structured Append) must be followed by nine digits, composed of three-digit numbers with values between 1 and 254, that represent the symbol sequence and file identifier (for example, symbol 3 of 7 with file ID 1001 is represented by `~2214001001`)
- `5NNN` is code page NNN where NNN is a three-digit code page value (for example, Code Page 9 is represented by `~5009`)
- `~dNNN` creates ASCII decimal value NNN for a code word (must be three digits)
- `~` in data is encoded by a `~` (tilde)

[^]BY – Bar Code Field Default

Description The [^]BY command is used to change the default values for the module width (in dots), the wide bar to narrow bar width ratio and the bar code height (in dots). It can be used as often as necessary within a label format.

Format [^]BYw,r,h

Parameters	Details
w = module width (in dots)	Accepted Values: 1 to 10 Initial Value at power-up: 2
r = wide bar to narrow bar width ratio	Accepted Values: 2.0 to 3.0, in 0.1 increments This parameter has no effect on fixed-ratio bar codes. Default Value: 3.0
h = bar code height (in dots)	Initial Value at power-up: 10

For parameter r, the actual ratio generated is a function of the number of dots in parameter w, module width. See Table 11 on page 147. Module width and height (w and h) can be changed at anytime with the [^]BY command, regardless of the symbology selected.



Example • Set module width (w) to 9 and the ratio (r) to 2.4. The width of the narrow bar is 9 dots wide and the wide bar is 9 by 2.4, or 21.6 dots. However, since the printer rounds out to the nearest dot, the wide bar is actually printed at 22 dots. This produces a bar code with a ratio of 2.44 (22 divided by 9). This ratio is as close to 2.4 as possible, since only full dots are printed.

Table 11 • Shows Module Width Ratios in Dots

Ratio Selected (r)	Module Width in Dots (w)									
	1	2	3	4	5	6	7	8	9	10
2.0	2:1	2:1	2:1	2:1	2:1	2:1	2:1	2:1	2:1	2:1
2.1	2:1	2:1	2:1	2:1	2:1	2:1	2:1	2:1	2:1	2.1:1
2.2	2:1	2:1	2:1	2:1	2.2:1	2.16:1	2.1:1	2.12:1	2.1:1	2.2:1
2.3	2:1	2:1	2.3:1	2.25:1	2.2:1	2.16:1	2.28:1	2.25:1	2.2:1	2.3:1
2.4	2:1	2:1	2.3:1	2.25:1	2.4:1	2.3:1	2.28:1	2.37:1	2.3:1	2.4:1
2.5	2:1	2.5:1	2.3:1	2.5:1	2.4:1	2.5:1	2.4:1	2.5:1	2.4:1	2.5:1
2.6	2:1	2.5:1	2.3:1	2.5:1	2.6:1	2.5:1	2.57:1	2.5:1	2.5:1	2.6:1
2.7	2:1	2.5:1	2.6:1	2.5:1	2.6:1	2.6:1	2.57:1	2.65:1	2.6:1	2.7:1
2.8	2:1	2.5:1	2.6:1	2.75:1	2.8:1	2.6:1	2.7:1	2.75:1	2.7:1	2.8:1
2.9	2:1	2.5:1	2.6:1	2.75:1	2.8:1	2.8:1	2.85:1	2.87:1	2.8:1	2.9:1
3.0	3:1	3:1	3:1	3:1	3:1	3:1	3:1	3:1	3:1	3:1

Comments Once a [^]BY command is entered into a label format, it stays in effect until another [^]BY command is encountered.

^CC ~CC – Change Caret

Description The ^CC command is used to change the format command prefix. The default prefix is the caret (^).

Format ^CCx or ~CCx

Parameters	Details
x = caret character change	<i>Accepted Values:</i> any ASCII character <i>Default Value:</i> a parameter is required. If a parameter is not entered, the next character received is the new prefix character.



Example • This is an example of how to change the format prefix to / from a ::

```
^XA
^CC/
/XZ
```

The forward slash (/) is set at the new prefix. Note the /XZ ending tag uses the new designated prefix character (/).



Example • This is an example of how to change the format prefix from ~ to a /:

```
~CC/
/XA/JUS/XZ
```

^BZ – POSTAL Bar Code

Description The POSTAL bar code is used to automate the handling of mail. POSTAL codes use a series of tall and short bars to represent the digits.

- ^BZ supports a print ratio of 2.0:1 to 3.0:1.
- Field data (^FD) is limited to the width (or length, if rotated) of the label and by the bar code specification.

Format ^BZo,h,f,g,t



Important • If additional information about the POSTAL and PLANET bar code is required, go to www.aimglobal.org, or contact the United States Postal Service <http://pe.usps.gov>. If additional information about the INTELLIGENT MAIL bar code is required, see: <http://ribbs.usps.gov/OneCodeSolution>.

Parameters	Details
o = orientation	<p><i>Accepted Values:</i></p> <p>N = normal R = rotated 90 degrees (clockwise) I = inverted 180 degrees B = read from bottom up, 270 degrees</p> <p><i>Default Value:</i> current ^FW value</p>
h = bar code height (in dots)	<p><i>Accepted Values:</i> 1 to 32000</p> <p><i>Default Value:</i> value set by ^BY</p>
f = print interpretation line	<p><i>Accepted Values:</i></p> <p>N = no Y = yes</p> <p><i>Default Value:</i> N</p>
g = print interpretation line above code	<p><i>Accepted Values:</i></p> <p>N = no Y = yes</p> <p><i>Default Value:</i> N</p>
t = Postal code type	<p><i>Accepted Values:</i></p> <p>0 = Postnet bar code 1 = Plant Bar Code 2 = Reserved 3 = USPS Intelligent Mail bar code</p> <p><i>Default Value:</i> 0</p>

➔ **Example 1** • This is an example of a POSTNET bar code:

ZPL II CODE	POSTNET BAR CODE								
<pre> ^XA ^FO100,100^BY3 ^BZN,40,Y,N ^FD12345^FS ^XZ </pre>	 <p>12345</p>								
POSTNET BAR CODE CHARACTERS									
0	1	2	3	4	5	6	7	8	9

➔ **Example 2** • This is an example of a USPS Intelligent Mail bar code:

ZPL II CODE	USPS INTELLIGENT MAIL BAR CODE
<pre> ^XA ^FO100,040^BZ,40,,,3 ^FD00123123456123456789^FS ^XZ </pre>	

^CD ~CD – Change Delimiter

Description The ^CD and ~CD commands are used to change the delimiter character. This character is used to separate parameter values associated with several ZPL II commands. The default delimiter is a comma (,).

Format ^CDa or ~CDa

Parameters	Details
a = delimiter character change	<i>Accepted Values:</i> any ASCII character <i>Default Value:</i> a parameter is required. If a parameter is not entered, the next character received is the new prefix character.



Example • This shows how to change the character delimiter to a semi-colon (;):

```
^XA
^F010,10
^GB10,10,3
^XZ
^XA
^CD;
^F010;10
^GB10;10;3
^XZ
• To save, the JUS command is required. Here is an example using JUS:
~CD;
^XA^JUS^XZ
```

^CF – Change Alphanumeric Default Font

Description The ^CF command sets the default font used in your printer. You can use the ^CF command to simplify your programs.

Format ^CFf,h,w

Parameters	Details
f = specified default font	Accepted Values: A through Z and 0 to 9 Initial Value at power-up: A
h = individual character height (in dots)	Accepted Values: 0 to 32000 Initial Value at power-up: 9
w = individual character width (in dots)	Accepted Values: 0 to 32000 Initial Value at power-up: 5 or last permanent saved value

Parameter **f** specifies the default font for every alphanumeric field. Parameter **h** is the default height for every alphanumeric field, and parameter **w** is the default width value for every alphanumeric field.

The default alphanumeric font is A. If you do not change the alphanumeric default font and do not use any alphanumeric field command (^AF) or enter an invalid font value, any data you specify prints in font A.

Defining only the height or width forces the magnification to be proportional to the parameter defined. If neither value is defined, the last ^CF values given or the default ^CF values for height and width are used.



Example • This is an example of ^CF code and the result of the code:

ZPL II CODE	GENERATED LABEL
<pre> ^XA ^CF0,89 ^FO20,50 ^FDA GUIDE TO^FS ^FO20,150 ^FDTHE ZPL II^FS ^FO20,250 ^FDPROGRAMMING^FS ^FO20,350 ^FDLANGUAGE^FS ^XZ </pre>	

Comments Any font in the printer, including downloaded fonts, EPROM stored fonts, and fonts A through Z and 0 to 9, can also be selected with ^CW.

^{^CI} - Change International Font/Encoding

Description Zebra printers can print fonts using international character sets: U.S.A.1, U.S.A.2, UK, Holland, Denmark/Norway, Sweden/Finland, Germany, France 1, France 2, Italy, Spain, and several other sets, including the Unicode character set.

The ^{^CI} command enables you to call up the international character set you want to use for printing. You can mix character sets on a label.

A character within a font can be remapped to a different numerical position.



In x.14 version of firmware and later, this command allows character remapping when parameter **a** = 0-13.

Format ^{^CI}a, s1, d1, s2, d2, . . .

Parameters	Details
a = desired character set	<p>Accepted values 0 - 12 are Zebra Code Page 850 with specific character replacements. For details, see International Character Sets on page 156 and/or Zebra Code Page 850 — Latin Character Set on page 1194.</p> <p><i>Accepted Values:</i></p> <ul style="list-style-type: none"> 0 = Single Byte Encoding - U.S.A. 1 Character Set 1 = Single Byte Encoding - U.S.A. 2 Character Set 2 = Single Byte Encoding - U.K. Character Set 3 = Single Byte Encoding - Holland Character Set 4 = Single Byte Encoding - Denmark/Norway Character Set 5 = Single Byte Encoding - Sweden/Finland Character Set 6 = Single Byte Encoding - Germany Character Set 7 = Single Byte Encoding - France 1 Character Set 8 = Single Byte Encoding - France 2 Character Set 9 = Single Byte Encoding - Italy Character Set 10 = Single Byte Encoding - Spain Character Set <p><i>(parameter details continued on next page)</i></p>



Note • These parameters are only valid when parameter **a** = 1 - 13

- a. The encoding is controlled by the conversion table (***.DAT**). The correct table must be present for the conversion to function. The table generated by ZTools™ is the TrueType fonts internal encoding (Unicode).
- b. Shift-JIS encoding converts Shift-JIS to JIS and then looks up the JIS conversion in **JIS.DAT**. This table must be present for Shift-JIS to function.
- c. Supports ASCII transparency for Asian encodings. 7F and less are treated as single byte characters. 80 to FE is treated as the first byte of a 2 byte character 8000 to FEFF in the encoding table for Unicode.
- d. The ^{^CI}17 command has been deprecated, along with the ^{^F}8 and ^{^F}16 commands that are required for the ^{^CI}17 command to function. The recommended replacement is the ^{^CI}28-30 commands.

Parameters	Details
<p>a = desired character set (continued)</p> <p>.14† Values 28 to 30 are only supported in firmware version V60.14.x, V50.14.x, or later.</p> <p>.16† Values 31 to 36 are only supported in firmware version x.16.x or later.</p>	<p>11 = Single Byte Encoding - Miscellaneous Character Set</p> <p>12 = Single Byte Encoding - Japan (ASCII with Yen symbol) Character Set</p> <p>13 = Zebra Code Page 850 (see page 1194)</p> <p>14 = Double Byte Asian Encodings^a</p> <p>15 = Shift-JIS^b</p> <p>16 = EUC-JP and EUC-CN^a</p> <p>17 = Deprecated - UCS-2 Big Endian^d</p> <p>18 to 23 = Reserved</p> <p>24 = Single Byte Asian Encodings^a</p> <p>25 = Reserved</p> <p>26 = Multibyte Asian Encodings with ASCII Transparency^a and ^c</p> <p>27 = Zebra Code Page 1252 (see page 1198)</p> <p>28 = Unicode (UTF-8 encoding) - Unicode Character Set</p> <p>29 = Unicode (UTF-16 Big-Endian encoding) - Unicode Character Set</p> <p>30 = Unicode (UTF-16 Little-Endian encoding) - Unicode Character Set</p> <p>31 = Zebra Code Page 1250 (see page 1196) is supported for scalable fonts, such as Font 0, or a downloaded TrueType font. Bitmapped fonts (including fonts A-H) do not fully support Zebra Code Page 1250. This value is supported only on Zebra G-Series™ printers.</p> <p>33 = Code Page 1251</p> <p>34 = Code page 1253</p> <p>35 = Code Page 1254</p> <p>36 = Code Page 1255</p> <p><i>Initial Value at power-up: 0</i></p>
s1 = source 1 (character output image)	<i>Accepted Values:</i> decimals 0 to 255
d1 = destination 1 (character input)	<i>Accepted Values:</i> decimals 0 to 255
s2 = source 2 (character output image)	<i>Accepted Values:</i> decimals 0 to 255
d2 = destination 2 (character input)	<i>Accepted Values:</i> decimals 0 to 255
<p>a. The encoding is controlled by the conversion table (*.DAT). The correct table must be present for the conversion to function. The table generated by ZTools™ is the TrueType fonts internal encoding (Unicode).</p> <p>b. Shift-JIS encoding converts Shift-JIS to JIS and then looks up the JIS conversion in JIS.DAT. This table must be present for Shift-JIS to function.</p> <p>c. Supports ASCII transparency for Asian encodings. 7F and less are treated as single byte characters. 80 to FE is treated as the first byte of a 2 byte character 8000 to FEFF in the encoding table for Unicode.</p> <p>d. The ^CI17 command has been deprecated, along with the ^F8 and ^F16 commands that are required for the ^CI17 command to function. The recommended replacement is the ^CI28-30 commands.</p>	

Parameters	Details
... = continuation of pattern	Up to 256 source and destination pairs can be entered in this command.

a. The encoding is controlled by the conversion table (* .DAT). The correct table must be present for the conversion to function. The table generated by ZTools™ is the TrueType fonts internal encoding (Unicode).

b. Shift-JIS encoding converts Shift-JIS to JIS and then looks up the JIS conversion in JIS .DAT. This table must be present for Shift-JIS to function.

c. Supports ASCII transparency for Asian encodings. 7F and less are treated as single byte characters. 80 to FE is treated as the first byte of a 2 byte character 8000 to FEFF in the encoding table for Unicode.

d. The ^CI17 command has been deprecated, along with the ^F8 and ^F16 commands that are required for the ^CI17 command to function. The recommended replacement is the ^CI28-30 commands.



80 to FF could mean quad byte in GB18030. The ^CI26 command can also be used to support the GB 18030 and Big5 HKSCS encodings. The GB 18030 uses the GB18030.DAT encoding table and BIG5 HKSCS uses the BIG5HK.DAT encoding table.



The ^CI17 command has been deprecated, along with the ^F8 and ^F16 commands that are required for the ^CI17 command to function. The recommended replacement is the ^CI28-30 commands.



We recommend that a ^CI command (or Unicode BOM) is included at the beginning of each ZPL script. This is important when ZPL scripts with different encodings are being sent to a single printer. To assist in the interleaving of encoding schemes, the printer maintains two encoding states (^CI0 - 28 and ^CI29 - 30). It automatically acknowledges when it should switch encoding states, allowing it to distinguish between encodings, and maintains a ^CI for each, but endianness is shared.



Example • This example remaps the Euro symbol (21) decimal to the dollar sign value (36) decimal. When the dollar sign character is sent to the printer, the Euro symbol prints:

ZPL II CODE	GENERATED LABEL
<pre> ^XA ^CI0,21,36 ^FO100,200^A0N50,50^FD\$0123^FS ^XZ </pre>	

The font selected determines the shape and resolution of the printed symbol.

International Character Sets

Hex	2	3	4	5	5	5	5	6	7	7	7	7
	3	0	0	B	C	D	E	0	B	C	D	E
CI0	#	0	@	[Φ]	^	'	{		}	~
CI1	#	0	@	¼	Φ	¾	^	'	¼	½	¾	~
CI2	£	0	@	[Φ]	^	'	{		}	~
CI3	f	0	§	[U]	^	'	{	ij	}	~
CI4	#	0	@	Æ	Ø	Å	^	'	æ	ø	å	~
CI5	Ü	0	É	Ä	Ö	À	Ü	é	ä	ö	à	ü
CI6	#	0	§	Ä	Ö	Ü	^	'	ä	ö	ü	ß
CI7	£	0	à	[ç]	^	'	é	ì	ù	è
CI8	#	0	à	â	ç	ê	î	ô	é	ù	è	û
CI9	£	0	§	[ç	é	^	ù	à	ò	è	ì
CI10	#	0	§	ì	Ñ	¿	^	'	{	ñ	ç	~
CI11	£	0	É	Ä	Ö	Ü	^	'	ä	ë	ï	ö
CI12	#	0	@	[¥]	^	'	{		}	~
CI13	#	0	@	[\]	^	'	{		}	~



Note • ^CI 13 = US keyboard

Comments The *space* character cannot be remapped for any font.

^CM – Change Memory Letter Designation

Description The ^CM command allows you to reassign a letter designation to the printer's memory devices. If a format already exists, you can reassign the memory device to the corresponding letter without forcing, altering, or recreating the format itself.

Using this command affects every subsequent command that refers to specific memory locations.

Format ^CMa,b,c,d

Parameters	Details
a = memory alias for B:	Accepted Values: B:, E:,R:, A:, and NONE Default Value: B:
b = memory alias for E:	Accepted Values: B:, E:,R:, A:, and NONE Default Value: E:
c = memory alias for R:	Accepted Values: B:, E:,R:, A:, and NONE Default Value: R:
d = memory alias for A:	Accepted Values: B:, E:,R:, A:, and NONE Default Value: A:
e = multiple alias	Accepted Values: M, or no value Default Value: no value <ul style="list-style-type: none"> • This parameter is supported on Xi4 and ZM400/ZM600 printers using firmware V53.17.7Z or later. • This parameter is supported on G-Series printers using firmware versions v56.17.7Z and v61.17.7Z or later. • This parameter is supported on printers using firmware V60.17.7Z or later.

Comments Unless the e (multiple alias) parameter is used, when two or more parameters specify the same letter designator, all letter designators are set to their default values.

It is recommended that after entering the ^CM command, ^JUS is entered to save changes to EEPROM. Any duplicate parameters entered will reset the letter designations back to the default.

If any of the parameters are out of specification, the command is ignored.



Example 1 • This example designates letter E: to point to the B: memory device, and the letter B: to point to the E:memory device.

```
^XA
^CME,B,R,A
^JUS
^XZ
```



Example 2 • This example designates that content sent to, or read from the B: or E: memory locations will be sent to or read from the E: memory location.

```
^XA  
^CME, E, R, A, M  
^JUS  
^XZ
```



Example 3 • This example designates that content sent to, or read from the A: or E: memory locations will be sent to or read from the E: memory location.

```
^XA  
^CMB, E, R, E, M  
^JUS  
^XZ
```



Example 4 • This example designates that content sent to, or read from the A:, B: or E: memory locations will be sent to or read from the E: memory location.

```
^XA  
^CME, E, R, E, M  
^JUS  
^XZ
```



Note • Examples 2, 3 and 4 are the only valid uses of the multiple alias parameter.

^CN – Cut Now

Description The ^CN causes the printer to cycle the media cutter.



Important • This command works only when the printer is in Print Mode Kiosk (^MMk). If the printer is not in Print Mode Kiosk, then using this command has no effect. See ^MM on page 303.

Supported Devices

- KR403

Format ^CNa

Parameters	Details
a = Cut Mode Override	<p><i>Accepted Values:</i></p> <ul style="list-style-type: none">0 = Use the “kiosk cut amount” setting from ^KV1 = Ignore “kiosk cut amount” from ^KV and do a full cut <p><i>Default Value:</i> none</p> <p>The command is ignored if parameters are missing or invalid.</p>

^CO – Cache On

Description The ^CO command is used to change the size of the character cache. By definition, a *character cache* (referred to as cache) is a portion of the DRAM reserved for storing scalable characters. All printers have a default 40K cache that is always turned on. The maximum single character size that can be stored, without changing the size of the cache, is 450 dots by 450 dots.

There are two types of fonts used in Zebra printers: bitmapped and scalable. Letters, numbers, and symbols in a bitmapped font have a fixed size (for example: 10 points, 12 points, 14 points). By comparison, scalable fonts are not fixed in size.

Because their size is fixed, bitmapped fonts can be moved quickly to the label. In contrast, scalable fonts are much slower because each character is built on an as-needed basis before it is moved to the label. By storing scaled characters in a cache, they can be recalled at a much faster speed.

The number of characters that can be stored in the cache depends on two factors: the size of the cache (memory) and the size of the character (in points) being saved. The larger the point size, the more space in the cache it uses. The default cache stores every scalable character that is requested for use on a label. If the same character, with the same rotation and size is used again, it is quickly retrieved from cache.

It is possible that after a while the print cache could become full. Once the cache is full, space for new characters is obtained by eliminating an existing character from the print cache. Existing characters are eliminated by determining how often they have been used. This is done automatically. For example, a 28-point *Q* that was used only once would be a good candidate for elimination from the cache.

Maximum size of a single print cache character is 1500 dots by 1500 dots. This would require a cache of 274K. When the cache is too small for the desired style, smaller characters might appear but larger characters do not. If possible, increase the size of the cache.

Format ^COa,b,c

Parameters	Details
a = cache on	<p><i>Accepted Values:</i></p> <p>N = no Y = yes</p> <p><i>Default Value:</i> Y</p>
b = amount of additional memory to be added to cache (in K)	<p><i>Accepted Values:</i> 1 to 9999</p> <p><i>Default Value:</i> 40</p>
c = cache type	<p><i>Accepted Values:</i></p> <p>0 = cache buffer (normal fonts) 1 = internal buffer (recommended for Asian fonts)</p> <p><i>Default Value:</i> 0</p>



Example • To resize the print cache to 62K, assuming a 22K existing cache:

```
^COY,40
```

To resize the print cache to 100K, assuming a 22K existing cache:

```
^COY,78
```

Print Cache Performance

For printing large characters, memory added to the cache by the ^CO command is not physically added to the 22K cache already in the printer. In the second example above, the resulting 100K cache is actually two separate blocks of memory, 22K and 78K.

Because large characters need contiguous blocks of memory, a character requiring a cache of 90K would not be completely stored because neither portion of the 100K cache is big enough. Therefore, if large characters are needed, the ^CO command should reflect the actual size of the cache you need.

Increasing the size of the cache improves the performance in printing scalable fonts. However, the performance decreases if the size of the cache becomes large and contains too many characters. The performance gained is lost because of the time involved searching the cache for each character.

Comments The cache can be resized as often as needed. Any characters in the cache when it is resized are lost. Memory used for the cache reduces the space available for label bitmaps, graphic, and fonts.

Some Asian fonts require an internal working buffer that is much larger than the normal cache. Since most fonts do not require this larger buffer, it is now a selectable configuration option. Printing with the Asian fonts greatly reduces the printer memory available for labels, graphics, fonts, formats, and label bitmaps.



Note • If you have firmware x.12 or greater this command is not required because the printer firmware automatically expands the size of the character cache as needed.

^CP – Remove Label

Description The ^CP command causes the printer to move a printed label out of the presenter area in one of several ways.

Supported Devices

- KR403

Format ^CPa

Parameters	Details
a = kiosk present mode	<p><i>Accepted Values:</i></p> <p>0 = Eject presented page</p> <p>1 = Retracts presented page</p> <p>2 = Takes the action defined by c parameter of ^KV command.</p> <p><i>Default Value:</i> none</p> <p>The command is ignored if parameters are missing or invalid.</p>

^CT ~CT - Change Tilde

Description The ^CT and ~CT commands are used to change the control command prefix. The default prefix is the tilde (~).

Format ^CTa or ~CTa

Parameters	Details
a = change control command character	<i>Accepted Values:</i> any ASCII character <i>Default Value:</i> a parameter is required. If a parameter is not entered, the next character received is the new control command character.



Example • This is an example of how to change the control command prefix from a ^ to a +:

```
^XA  
^CT+  
^XZ  
+HS
```

^CV – Code Validation

Description The ^CV command acts as a switch to turn the code validation function on and off. When this command is turned on, all bar code data is checked for these error conditions:

- character not in character set
- check-digit incorrect
- data field too long (too many characters)
- data field too short (too few characters)
- parameter string contains incorrect data or missing parameter

When invalid data is detected, an error message and code is printed in reverse image in place of the bar code. The message reads **INVALID - X** where **X** is one of these error codes:

- C** = character not in character set
- E** = check-digit incorrect
- L** = data field too long
- S** = data field too short
- P** = parameter string contains incorrect data
(occurs only on select bar codes)

Once turned on, the ^CV command remains active from format to format until turned off by another ^CV command or the printer is turned off. The command is not permanently saved.

Format ^CVa

Parameters	Details
a = code validation	<i>Accepted Values:</i> N = no Y = yes <i>Default Value:</i> N



Example • The examples below show the error labels `^CVY` generates when incorrect field data is entered. Compare the letter following *INVALID* – to the listing on the previous page.

ZPL II CODE	GENERATED LABEL
<pre> ^XA ^CVY ^FO50,50 ^BEN,100,Y,N ^FD97823456 890^FS ^XZ </pre>	
<pre> ^XA ^CVY ^FO50,50 ^BEN,100,Y,N ^FD9782345678907^FS ^XZ </pre>	
<pre> ^XA ^CVY ^FO50,50 ^BEN,100,Y,N ^FD97823456789081^FS ^XZ </pre>	
<pre> ^XA ^CVY ^FO50,50 ^BEN,100,Y,N ^FD97823456789^FS ^XZ </pre>	
<pre> ^XA ^CVY ^FO50,50 ^BQN2,3 ^FDHM,BQRCODE-22^FS ^XZ </pre>	

Comments If more than one error exists, the first error detected is the one displayed.

The `^CV` command tests the integrity of the data encoded into the bar code. It is not used for (or to be confused with) testing the scan-integrity of an image or bar code.

^CW – Font Identifier

Description All built-in fonts are referenced using a one-character identifier. The ^CW command assigns a single alphanumeric character to a font stored in DRAM, memory card, EPROM, or Flash.

If the assigned character is the same as that of a built-in font, the downloaded font is used in place of the built-in font. The new font is printed on the label wherever the format calls for the built-in font. If used in place of a built-in font, the change is in effect only until power is turned off.

If the assigned character is different, the downloaded font is used as an additional font. The assignment remains in effect until a new command is issued or the printer is turned off.

Format ^Cwa,d:o.x

Parameters	Details
a = letter of existing font to be substituted, or new font to be added	<i>Accepted Values:</i> A through Z and 0 to 9 <i>Default Value:</i> a one-character entry is required
d = device to store font in (optional)	<i>Accepted Values:</i> R:, E:, B:, and A: <i>Default Value:</i> R:
o = name of the downloaded font to be substituted for the built-in, or as an additional font	<i>Accepted Values:</i> any name up to 8 characters <i>Default Value:</i> if a name is not specified, UNKNOWN is used
x = extension  .TTE is only supported in firmware version V60.14.x, V50.14.x, or later.	<i>Accepted Values:</i> <ul style="list-style-type: none"> .FNT = Font .TTF = TrueType Font .TTE = TrueType Extension



Example • These examples show how to use:

- MYFONT.FNT stored in DRAM whenever a format calls for Font A:
 ^XA
 ^CWA,R:MYFONT.FNT
 ^XZ
- MYFONT.FNT stored in DRAM additionally as Font Q:
 ^XA
 ^CWQ,R:MYFONT.FNT
 ^XZ
- NEWFONT.FNT stored in DRAM whenever a format calls for font F:
 ^XA
 ^CWF,R:NEWFONT.FNT
 ^XZ

DIRECTORY OF R:*. *	
R:NEWFONT.FNT	65268
R:MYFONT.FNT	65268
582164 BYTES FREE R:	

Label Listing Before Assignment

DIRECTORY OF R:*. *	
F R:NEWFONT.FNT	65268
AQ R:MYFONT.FNT	65268
582164 BYTES FREE R:	

Label Listing After Assignment

~DB – Download Bitmap Font

Description The ~DB command sets the printer to receive a downloaded bitmap font and defines native cell size, baseline, space size, and copyright.

This command consists of two portions, a ZPL II command defining the font and a structured data segment that defines each character of the font.

Format ~DBd:o.x,a,h,w,base,space,#char,®,data

Parameters	Details
d = drive to store font	<i>Accepted Values:</i> R:, E:, B:, and A: <i>Default Value:</i> R:
o = name of font	<i>Accepted Values:</i> 1 to 8 alphanumeric characters <i>Default Value:</i> if a name is not specified, UNKNOWN is used
x = extension	<i>Format:</i> .FNT
a = orientation of native font	<i>Fixed Value:</i> normal
h = maximum height of cell (in dots)	<i>Accepted Values:</i> 1 to 32000 <i>Default Value:</i> a value must be specified
w = maximum width of cell (in dots)	<i>Accepted Values:</i> 1 to 32000 <i>Default Value:</i> a value must be specified
base = dots from top of cell to character baseline	<i>Accepted Values:</i> 1 to 32000 <i>Default Value:</i> a value must be specified
space = width of space or non-existent characters	<i>Accepted Values:</i> 1 to 32000 <i>Default Value:</i> a value must be specified
#char = number of characters in font	<i>Accepted Values:</i> 1 to 256 (must match the characters being downloaded) <i>Default Value:</i> a value must be specified
® = copyright holder	<i>Accepted Values:</i> 1 to 63 alphanumeric characters <i>Default Value:</i> a value must be specified

Parameters	Details
<code>data</code> = structured ASCII data that defines each character in the font	<p>The # symbol signifies character code parameters, which are separated with periods. The character code is from 1 to 4 characters to allow for large international character sets to be downloaded to the printer.</p> <p>The data structure is:</p> <pre>#xxx.h.w.x.y.i.data</pre> <p>#xxx = character code</p> <p>h = bitmap height (in dot rows)</p> <p>w = bitmap width (in dot rows)</p> <p>x = x-offset (in dots)</p> <p>y = y-offset (in dots)</p> <p>i = typesetting motion displacement (width, including inter character gap of a particular character in the font)</p> <p><code>data</code> = hexadecimal bitmap description</p>



Example • This is an example of how to use the ~DB command. It shows the first two characters of a font being downloaded to DRAM.

```
~DBR:TIMES.FNT,N,5,24,3,10,2,ZEBRA 1992,
#0025.5.16.2.5.18.
00FF
00FF
FF00
FF00
FFFF
#0037.4.24.3.6.26.
00FF00
0F00F0
0F00F0
00FF00
```

~DE - Download Encoding

Description The standard encoding for TrueType Windows® fonts is always Unicode. The ZPL II field data must be converted from some other encoding to Unicode that the Zebra printer understands. The required translation tables are provided with font packs. Some tables can be downloaded from www.zebra.com.

Format ~DEd:o.x,s,data

Parameters	Details
d = location of table	<i>Accepted Values:</i> R:, E:, B:, and A: <i>Default Value:</i> R:
o = name of table	<i>Accepted Values:</i> any valid name, up to 8 characters <i>Default Value:</i> if a name is not specified, UNKNOWN is used
x = extension	<i>Format:</i> .DAT
s = table size	<i>Accepted Values:</i> the number of memory bytes required to hold the Zebra downloadable format of the font <i>Default Value:</i> if an incorrect value or no value is entered, the command is ignored
data = data string	<i>Accepted Values:</i> a string of ASCII hexadecimal values <i>Default Value:</i> if no data is entered, the command is ignored



Example • This is an example of how to download the required translation table:

```
~DER:JIS.DAT,27848,300021213001...
```

(27848 two-digit hexadecimal values)

Comments For more information on ZTools or ZebraNet Bridge, see the program documentation included with the software.

For assistance with editing or adding mappings to .DAT tables, ZebraNet Bridge includes a .DAT table editor in the font wizard.

Encoding scheme for the data sent to the printer is the second four character and the encoding scheme for the font is the first four characters throughout the .DAT file. The data must be ordered by the second four characters (the encoding table).



Example • This is an example of a .DAT table. The table below the example identifies the elements:

```
~DEE: EXAMPLE .DAT, 16,  
00310041 ←———— 1  
00320042 ←———— 2  
00330043 ←———— 3  
00340044 ←———— 4
```

1	Input stream with 0041 will be mapped to 0031. The printer prints "1".
2	Input stream with 0042 will be mapped to 0032. The printer prints "2".
3	Input stream with 0043 will be mapped to 0033. The printer prints "3".
4	Input stream with 0044 will be mapped to 0034. The printer prints "4".

Data must have 0041, 0042, 0043, and 0044 in order. Multiple pairs can be on the same line.

^DF – Download Format

Description The ^DF command saves ZPL II format commands as text strings to be later merged using ^XF with variable data. The format to be stored might contain field number (^FN) commands to be referenced when recalled.

While use of stored formats reduces transmission time, no formatting time is saved—this command saves ZPL II as text strings formatted at print time.

Enter the ^DF stored format command immediately after the ^XA command, then enter the format commands to be saved.

Format ^DFd:o.x

Parameters	Details
d = device to store image	<i>Accepted Values:</i> R:, E:, B:, and A: <i>Default Value:</i> R:
o = image name	<i>Accepted Values:</i> 1 to 8 alphanumeric characters <i>Default Value:</i> if a name is not specified, UNKNOWN is used
x = extension	<i>Format:</i> .ZPL

For a complete example of the ^DF and ^XF command, see [^DF and ^XF — Download format and recall format on page 56](#).



Example • This example is generated using the ^XF command to recall this format:

ZPL II CODE	GENERATED LABEL
<pre> ^XA ^DFR:STOREFMT.ZPL^FS ^FO25,25 ^AD,36,20^FN1^FS ^FO165,25 ^AD,36,20^FN2^FS ^FO25,75 ^AB,22,14^FDBUILT BY^FS ^FO25,125 ^AE,28,15^FN1 ^XZ ^XA ^XFR:STOREFMT.ZPL^FS ^FN1^FDZEBRA^FS ^XZ </pre>	<div style="border: 1px solid black; padding: 10px; text-align: center;"> <p>ZEBRA PRINTER</p> <p>BUILT BY</p> <p>ZEBRA</p> </div>

~DG – Download Graphics

Description The ~DG command downloads an ASCII Hex representation of a graphic image. If .GRF is not the specified file extension, .GRF is automatically appended.

For more saving and loading options when downloading files, see ~DY on page 180.

Format ~DGd:o.x,t,w,data

Parameters	Details
d = device to store image	<i>Accepted Values:</i> R:, E:, B:, and A: <i>Default Value:</i> R:
o = image name	<i>Accepted Values:</i> 1 to 8 alphanumeric characters <i>Default Value:</i> if a name is not specified, UNKNOWN is used
x = extension	<i>Format:</i> .GRF
t = total number of bytes in graphic	See the formula in the examples below.
w = number of bytes per row	See the formula in the examples below.
data = ASCII hexadecimal string defining image	The data string defines the image and is an ASCII hexadecimal representation of the image. Each character represents a horizontal nibble of four dots.

This is the key for the examples that follow:

- x = width of the graphic in millimeters
- y = height of the graphic in millimeters
- z = dots/mm = print density of the printer being programmed
- 8 = bits/byte



Examples • These are some example related to the ~DG command:

To determine the **t** parameter use this formula:

$$\frac{xz}{8} \times yz = \text{totalbytes}$$

To determine the correct **t** parameter for a graphic 8 mm wide, 16 mm high, and a print density of 8 dots/mm, use this formula:

$$8 \times 128 = 1024$$

$$t = 1024$$

Raise any portion of a byte to the next whole byte.

To determine the **w** parameter (the width in terms of bytes per row) use this formula:

$$\frac{xz}{8} = (\text{totalbytes})/(\text{row})$$

$$w = 8$$

To determine the correct **w** parameter for a graphic 8 mm wide and a print density of 8 dots/mm, use this formula:

$$\frac{8 \times 8}{8} = 8 \text{ bytes}$$

$$w = 8$$

Raise any portion of a byte to the next whole byte.

Parameter **w** is the first value in the **t** calculation.

The data parameter is a string of hexadecimal numbers sent as a representation of the graphic image. Each hexadecimal character represents a horizontal nibble of four dots. For example, if the first four dots of the graphic image are white and the next four black, the dot-by-dot binary code is 00001111. The hexadecimal representation of this binary value is 0F. The entire graphic image is coded in this way, and the complete graphic image is sent as one continuous string of hexadecimal values.

This is an example of using the ~DG command to load a checkerboard pattern into DRAM. The name used to store the graphic is SAMPLE.GRF:

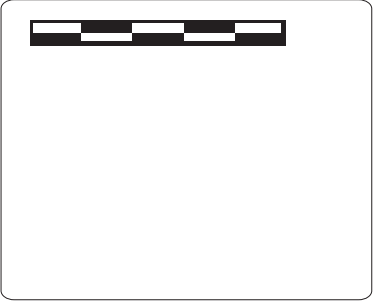
ZPL II CODE	GENERATED LABEL
<pre>~DGR: SAMPLE.GRF, 00080, 010, FFFFFFFFFFFFFFFFFFFF 8000FFFF0000FFFF0001 8000FFFF0000FFFF0001 8000FFFF0000FFFF0001 FFFF0000FFFF0000FFFF FFFF0000FFFF0000FFFF FFFF0000FFFF0000FFFF FFFFFFFFFFFFFFFFFFFF ^XA ^F020, 20^XGR: SAMPLE.GRF, 1, 1^FS ^XZ</pre>	

Comments Do not use spaces or periods when naming your graphics. Always use different names for different graphics.

If two graphics with the same name are sent to the printer, the first graphic is erased and replaced by the second graphic.

~DN – Abort Download Graphic

Description After decoding and printing the number of bytes in parameter **t** of the ~DG command, the printer returns to normal Print Mode. Graphics Mode can be aborted and normal printer operation resumed by using the ~DN command.

Format ~DN

Comments If you need to stop a graphic from downloading, you should abort the transmission from the host device. To clear the ~DG command, however, you must send a ~DN command.

~DS – Download Intellifont (Scalable Font)

Description The ~DS command is used to set the printer to receive a downloadable scalable font and defines the size of the font in bytes.

The ~DS command, and its associated parameters, is the result of converting a vendor-supplied font for use on a Zebra printer. To convert this font use the ZTools utility.

Format ~DSd:o.x,s,data

Parameters	Details
d = device to store image	<i>Accepted Values:</i> R:, E:, B:, and A: <i>Default Value:</i> R:
o = image name	<i>Accepted Values:</i> 1 to 8 alphanumeric characters <i>Default Value:</i> if a name is not specified, UNKNOWN is used
x = extension	<i>Fixed Value:</i> .FNT
s = size of font in bytes	<i>Fixed Value:</i> this number is generated by ZTools and should not be changed
data = ASCII hexadecimal string that defines font	<i>Fixed Value:</i> this number is generated by ZTools and should not be changed



Example • This example shows the first three lines of a scalable font that was converted using the ZTools program and is ready to be downloaded to the printer. If necessary, the destination and object name can be changed.

```
~DSB:CGTIMES.FNT,37080,  
00FF00FF00FF00FF  
FF0AECB28FF00FF
```

Comments Downloaded scalable fonts are not checked for integrity. If they are corrupt, they cause unpredictable results at the printer.



If you are using a TrueType font use these commands: ~DT, ~DU, and ~DY. To determine when to use the noted commands, see ~DT on page 178, ~DU on page 179, and ~DY on page 180.

~DT – Download Bounded TrueType Font

Description Use ZTools to convert a TrueType font to a Zebra-downloadable format. that has less than 256 characters in it. To convert a font that has more than 256 characters, see [~DU on page 179](#). ZTools creates a downloadable file that includes a ~DT command. For information on converting and downloading Intellifont information, see [~DS on page 177](#).

Format ~DTd:o,x,s,data

Parameters	Details
d = font location	<i>Accepted Values:</i> R:, E:, B:, and A: <i>Default Value:</i> R:
o = font name	<i>Accepted Values:</i> any valid TrueType name, up to 8 characters <i>Default Value:</i> if a name is not specified, UNKNOWN is used
x = extension	<i>Fixed Value:</i> .DAT
s = font size	<i>Accepted Values:</i> the number of memory bytes required to hold the Zebra-downloadable format of the font <i>Default Value:</i> if an incorrect value or no value is entered, the command is ignored
data = data string	<i>Accepted Values:</i> a string of ASCII hexadecimal values (two hexadecimal digits/byte). The total number of two-digit values must match parameter s. <i>Default Value:</i> if no data is entered, the command is ignored



Example • This is an example of how to download a true type font:

```
~DTR:FONT,52010,00AF01B0C65E...
```

(52010 two-digit hexadecimal values)

~DU – Download Unbounded TrueType Font

Description Some international fonts, such as Asian fonts, have more than 256 printable characters. These fonts are supported as *large TrueType fonts* and are downloaded to the printer with the ~DU command. Use ZTools to convert the large TrueType fonts to a Zebra-downloadable format.

The Field Block (^FB) command cannot support the large TrueType fonts.

Format ~DUd:o.x,s,data

Parameters	Details
d = font location	<i>Accepted Values:</i> R:, E:, B:, and A: <i>Default:</i> R:
o = font name	<i>Accepted Values:</i> 1 to 8 alphanumeric characters <i>Default Value:</i> if a name is not specified, UNKNOWN is used
x = extension	<i>Format:</i> .FNT
s = font size	<i>Accepted Values:</i> the number of memory bytes required to hold the Zebra-downloadable format of the font <i>Default Value:</i> if no data is entered, the command is ignored
data = data string	<i>Accepted Values:</i> a string of ASCII hexadecimal values (two hexadecimal digits/byte). The total number of two-digit values must match parameter s. <i>Default Value:</i> if no data is entered, the command is ignored



Example • This is an example of how to download an unbounded true type font:

```
~DUR:KANJI,86753,60CA017B0CE7...
```

(86753 two-digit hexadecimal values)

For similar commands, see [~DS on page 177](#), [~DT on page 178](#), and [~DY on page 180](#).

~DY – Download Objects

Description The ~DY command downloads to the printer graphic objects or fonts in any supported format. This command can be used in place of ~DG for more saving and loading options. ~DY is the preferred command to download TrueType fonts on printers with firmware later than X.13. It is faster than ~DU. The ~DY command also supports downloading wireless certificate files.





Note • When using certificate files, your printer supports:

- Using Privacy Enhanced Mail (PEM) formatted certificate files.
- Using the client certificate and private key as two files, each downloaded separately.
- Using exportable PAC files for EAP-FAST.
- Zebra recommends using Linear style memory devices for storing larger objects.

Format ~DYd:f,b,x,t,w,data

Parameters	Details
<p>d = file location</p> <p>.15↑</p> <p>.NRD and .PAC files reside on E: in firmware versions V60.15.x, V50.15.x, or later.</p>	<p><i>Accepted Values:</i> R:, E:, B:, and A:</p> <p><i>Default Value:</i> R:</p>
<p>f = file name</p>	<p><i>Accepted Values:</i> 1 to 8 alphanumeric characters</p> <p><i>Default Value:</i> if a name is not specified, UNKNOWN is used</p>
<p>b = format downloaded in data field</p> <p>.14↑</p> <p>.TTE and .TTF are only supported in firmware versions V60.14.x, V50.14.x, or later.</p>	<p><i>Accepted Values:</i></p> <p>A = uncompressed (ZB64, ASCII)</p> <p>B = uncompressed (.TTE, .TTF, binary)</p> <p>C = AR-compressed (used only by Zebra’s BAR-ONE® v5)</p> <p>P = portable network graphic (.PNG) - ZB64 encoded</p> <p><i>Default Value:</i> a value must be specified</p>

Parameters	Details
<p><code>x</code> = extension of stored file</p> <p>.14† .TTE and .OTF are only supported in firmware versions V60.14.x, V50.14.x, or later.</p> <p>.15† .NRD and .PAC are only supported in firmware versions V60.15.x, V50.15.x, or later.</p>	<p><i>Accepted Values:</i></p> <ul style="list-style-type: none"> B = bitmap E = TrueType Extension (.TTE) G = raw bitmap (.GRF) P = store as compressed (.PNG) T = TrueType (.TTF) or OpenType (.OTF) X = Paintbrush (.PCX) NRD = Non Readable File (.NRD) PAC = Protected Access Credential (.PAC) C = User defined menu file (WML) F = User defined webpage file (HTM) H = Printer feedback file (GET) <p><i>Default Value:</i> a value other than the accepted values defaults to .GRF</p>
<p><code>t</code> = total number of bytes in file</p> <p>.14† .TTE is only supported in firmware versions V60.14.x, V50.14.x, or later.</p>	<p><i>Accepted Values:</i></p> <ul style="list-style-type: none"> .BMP This parameter refers to the actual size of the file, not the amount of disk space. .GRF images: the size after decompression into memory This parameter refers to the actual size of the file, not the amount of disk space. .PCX This parameter refers to the actual size of the file, not the amount of disk space. .PNG images: This parameter refers to the actual size of the file, not the amount of disk space. .TTF This parameter refers to the actual size of the file, not the amount of disk space. .TTE This parameter refers to the actual size of the file, not the amount of disk space.

Parameters	Details
<p><code>w</code> = total number of bytes per row</p> <p> <code>.TTE</code> is only supported in firmware version V60.14.x, V50.14.x, or later.</p> <p> <code>.NRD</code> and <code>.PAC</code> files are supported in firmware version V60.15.x, V50.15.x, or later.</p>	<p><i>Accepted Values:</i></p> <ul style="list-style-type: none"> <code>.GRF</code> images: number of bytes per row <code>.PNG</code> images: value ignored <code>.TTF</code> images: value ignored <code>.TTE</code> images: value ignored <code>.NRD</code> images: value ignored <code>.PAC</code> images: value ignored
<p><code>data</code> = data</p>	<p>ASCII hexadecimal encoding, ZB64, or binary data, depending on <code>b</code>.</p> <ul style="list-style-type: none"> <code>A, P</code> = ASCII hexadecimal or ZB64 <code>B, C</code> = binary <p>When binary data is sent, all control prefixes and flow control characters are ignored until the total number of bytes needed for the graphic format is received.</p>



Note • When transmitting fonts or graphics, the `~DY` command and the binary content can be sent as two separate data streams. In cases where the `~DY` command and data content are sent separately, the connection to the printer must be maintained until both the command and data content have been sent. If the command and data content are sent separately, the data light on the printer will remain lit until it receives all the data called for in the `~DY` command. The download will be considered complete when the number of bytes called out in the `~DY` command have been received.

For best results, graphic files must be monochrome (black and white) or dithered.



Example • This is an example of how to download a binary TrueType Font file of `Size` bytes using the name `fontfile.ttf` and storing it to permanent flash memory on the printer:

```
~DYE:FONTFILE.TTF,B,T,SIZE,,
```



Examples • These examples show:

- that when the `^IM` command is used with the `^FO` command, the `^IM` command (see [^IM on page 247](#)) moves the `logo.png` file from a storage area to the 0,0 position on the label. This is the ZPL code:

```
^XA
^FO0,0^IMR:LOGO.PNG^FS
^XZ
```

- that when the `^IL` command (see [^IL on page 246](#)) is used at the beginning of a label format, it loads a stored image (`logo.png`) of a format and merges it with additional data. It is automatically positioned at the 0,0 position of the label and does not require the `^FO` command. This is the ZPL code:

```
^XA
^ILR:LOGO.PNG
^XZ
```

Comments For more information on ZB64 encoding and compression, see [ZB64 Encoding and Compression on page 1237](#).



These are some important things to know about this command in firmware version V60.14.x, V50.14.x, or later:

- ZebraNet Bridge can be used to download fonts and graphics with this command.
- OpenType tables are only supported when downloading the font with this command
- OpenType fonts (`.OTF`) are supported if they are downloaded as a TrueType font. In the printer `.OTF` fonts have the `.TTF` extension.

~EG – Erase Download Graphics

See [^ID](#) on page 244.

^FB – Field Block

Description The ^FB command allows you to print text into a defined *block type* format. This command formats an ^FD or ^SN string into a block of text using the origin, font, and rotation specified for the text string. The ^FB command also contains an automatic word-wrap function.

Format ^FBa,b,c,d,e

Parameters	Details
a = width of text block line (in dots)	<i>Accepted Values:</i> 0 to the width of the label <i>Default Value:</i> 0 If the value is less than font width or not specified, text does not print.
b = maximum number of lines in text block	<i>Accepted Values:</i> 1 to 9999 <i>Default Value:</i> 1 Text exceeding the maximum number of lines overwrites the last line. Changing the font size automatically increases or decreases the size of the block.
c = add or delete space between lines (in dots)	<i>Accepted Values:</i> -9999 to 9999 <i>Default Value:</i> 0 Numbers are considered to be positive unless preceded by a minus sign. Positive values add space; negative values delete space.
d = text justification	<i>Accepted Values:</i> L = left C = center R = right J = justified <i>Default Value:</i> L If J is used the last line is left-justified.
e = hanging indent (in dots) of the second and remaining lines	<i>Accepted Values:</i> 0 to 9999 <i>Default Value:</i> 0



Example • These are examples of how the ^FB command affects field data.

ZPL II CODE	GENERATED LABEL
<pre> ^XA ^CF0,30,30^FO25,50 ^FB250,4,, ^FDFD command that IS\& preceded by an FB \&command. ^FS ^XZ </pre>	<p>FD command that IS preceded by an FB command.</p>
<pre> ^XA ^CF0,30,30^FO25,50 ^FDFD command that IS NOT preceded by an FB command.^FS ^XZ </pre>	<p>FD command that IS NOT preceded by an FB cor</p>

Comments

This scheme can be used to facilitate special functions:

- \& = carriage return/line feed
- \(*) = soft hyphen (word break with a dash)
- \\ = backslash (\)

Item 1: ^CI13 must be selected to print a backslash (\).

Item 2: If a soft hyphen escape sequence is placed near the end of a line, the hyphen is printed. If it is not placed near the end of the line, it is ignored.

(*) = any alphanumeric character

- If a word is too long to print on one line by itself (and no soft hyphen is specified), a hyphen is automatically placed in the word at the right edge of the block. The remainder of the word is on the next line. The position of the hyphen depends on word length, not a syllable boundary. Use a soft hyphen within a word to control where the hyphenation occurs.
- Maximum data-string length is 3K, including control characters, carriage returns, and line feeds.
- Normal carriage returns, line feeds, and *word spaces* at line breaks are discarded.
- When using ^FT (Field Typeset), ^FT uses the baseline origin of the last possible line of text. Increasing the font size causes the text block to increase in size from bottom to top. This could cause a label to print past its top margin.
- When using ^FO (Field Origin), increasing the font size causes the text block to increase in size from top to bottom.
- ^FS terminates an ^FB command. Each block requires its own ^FB command.



While the **^FB** command has a text justification parameter that defines the justification of the text within the block, it also interacts with the justification of **^FO** and **^FT** that define the justification of the origin.

The **^FB** command does not support soft hyphens as a potential line break point. However, soft hyphen characters are always printed as if they were a hyphen.

The **^FB** command does not support complex text. For complex text support, use **^TB**.

^FC – Field Clock

Description The ^FC command is used to set the clock-indicators (delimiters) and the clock mode for use with the Real-Time Clock hardware. This command must be included within each label field command string each time the Real-Time Clock values are required within the field.

Format ^FCa,b,c

Parameters	Details
a = primary clock indicator character	<i>Accepted Values:</i> any ASCII character <i>Default Value:</i> %
b = secondary clock indicator character	<i>Accepted Values:</i> any ASCII character <i>Default Value:</i> none—this value cannot be the same as a or c
c = third clock indicator character	<i>Accepted Values:</i> any ASCII character <i>Default Value:</i> none—this value cannot be the same as a or b



Example • Entering these ZPL commands sets the primary clock indicator to %, the secondary clock indicator to {, and the third clock indicator to #. The results are printed on a label with Primary, Secondary, and Third as field data.

ZPL II CODE	GENERATED LABEL
<pre> ^XA ^FO10,100^A0N,50,50 ^FC%,{,# ^FDPrimary: %m/%d/%y^FS ^FO10,200^A0N,50,50 ^FC%,{,# ^FDSecondary: {m/{d/{y^FS ^FO10,300^A0N,50,50 ^FC%,{,# ^FDThird: #m/#d/#y^FS ^XZ </pre>	<div style="border: 1px solid black; padding: 10px; text-align: center;"> <p>Primary: 00/00/00</p> <p>Secondary: 01/01/00</p> <p>Third: 01/01/00</p> </div>

Comments The ^FC command is ignored if the Real Time Clock hardware is not present. As of V60.13.0.10, (^SN) functions with (^FC) capabilities.

For more details on the Real Time Clock, see [Real Time Clock on page 1249](#).

^FD – Field Data

Description The ^FD command defines the data string for a field. The field data can be any printable character except those used as command prefixes (^ and ~).

In RFID printers, it can also be used to specify passwords to write to tags.

Format ^FDa

Parameters	Details
a = <ul style="list-style-type: none">• data to be printed (all printers), or• a password to be written to a RFID tag (rfid printers)	<i>Accepted Values:</i> any data string up to 3072 bytes <i>Default Value:</i> none—a string of characters must be entered

Comments The ^ and ~ characters can be printed by changing the prefix characters—see [^CD ~CD on page 151](#) and [^CT ~CT on page 163](#). The new prefix characters cannot be printed.

Characters with codes above 127, or the ^ and ~ characters, can be printed using the ^FH and ^FD commands.

- ^CI13 must be selected to print a backslash (\).

For information on using soft hyphens, see [Comments on the ^FB command on page 186](#).

^FH – Field Hexadecimal Indicator

Description The ^FH command allows you to enter the hexadecimal value for any character directly into the ^FD statement. The ^FH command must precede each ^FD command that uses hexadecimals in its field.

Within the ^FD statement, the hexadecimal indicator must precede each hexadecimal value. The default hexadecimal indicator is _ (underscore). There must be a minimum of two characters designated to follow the underscore. The a parameter can be added when a different hexadecimal indicator is needed.

This command can be used with any of the commands that have field data (that is ^FD, ^FV (Field Variable), and ^SN (Serialized Data)).

Valid hexadecimal characters are:

0 1 2 3 4 5 6 7 8 9 A B C D E F a b c d e f

Format ^FH*a*

Parameters	Details
a = hexadecimal indicator	<p><i>Accepted Values:</i> any character except current format and control prefix (^ and ~ by default)</p> <p><i>Default Value:</i> _ (underscore)</p>



Example • This is an example of how to enter a hexadecimal value directly into a ^FD statement: This is an example for ascii data using ^CI0.

ZPL II CODE	GENERATED LABEL
<pre>^XA ^FO100,100 ^AD^FH ^FDTilde _7e used for HEX^FS ^XZ</pre>	<div style="border: 1px solid black; padding: 5px; text-align: center;"> Tilde ~ used for HEX </div>
<pre>^XA ^FO100,100 ^AD^FH\ ^FDTilde \7E used for HEX^FS ^XZ</pre>	<div style="border: 1px solid black; padding: 5px; text-align: center;"> Tilde ~ used for HEX </div>



Examples • These are examples of how ^FH works with UTF-8 and UTF-16BE:

UTF-8

ZPL II CODE	GENERATED LABEL
<pre> ^XA ^CI28 ^LL500 ^FO100,100 ^AA,20,20 ^FH^FDU+00A1 in UTF8 = _C2_A1^FS ^XZ </pre>	<pre> U+00A1 in UTF8 = i </pre>

UTF-16BE

ZPL II CODE	GENERATED LABEL
<pre> ^XA ^CI29 ^LL500 ^FO100,100 ^AA,20,20 ^FH^FDU+00A1 in UTF16BE = _00_A1^FS ^XZ </pre>	<pre> U+00A1 in UTF16BE = i </pre>

^FL – Font Linking



This command is available only for printers with firmware versions V60.14.x, V50.14.x, or later.

Description The ^FL command provides the ability to link any TrueType font, including private character fonts, to associated fonts.

If the base font does not have a glyph for the required character, the printer looks to the linked fonts for the glyph. The font links are user-definable. The font linking remains until the link is broken or the printer is turned off. To permanently save the font linking, use the ^JUS command.



Note • For assistance in setting up the font links, please use the font wizard in ZebraNet Bridge.

Format ^FL<ext>,<base>,<link>

Parameters	Details
<ext>	<p>This is the fully-qualified filename of the extension. This file name does not accept wildcards.</p> <p>The supported extensions for this parameter are: .TTF and .TTE. The format for this parameter is the memory device followed by the font name with the extension, as follows:</p> <p style="text-align: center;">E:SWISS721.TTF</p>
<base>	<p>This is the filename of the base font(s) to which <ext> is associated. This can be partially or fully wild carded; all files that match the wildcard specification will have this extension associated with it.</p> <p>The filename does not have to match a file that is currently defined on the printer. A specification of *.TTF results in all *.TTF font files loaded on the printer currently or in the future to be associated with the specified <ext> font extension.</p>
<link>	<p>This is an indicator that determines if the extension is to be linked with the base, or unlinked from the base, as follows:</p> <p><i>Accepted Values:</i></p> <p style="padding-left: 20px;">0 = <ext> is to be unlinked (disassociated) from the file(s) specified in <base></p> <p style="padding-left: 20px;">1 = <ext> is to be linked (associated) with the file(s) specified by <base></p> <p><i>Default Value:</i> must be an accepted value or it is ignored</p>

Comments A font can have up to five fonts linked to it. The printer resident font, **0.FNT** is always the last font in the list of font links, but is not included in the five link maximum. It can also be placed anywhere in the font links list.

The default glyph prints when a glyph cannot be found in any of the fonts in the link list. The advanced layout command ^PA determines if the default glyph is a space character or the default glyph of the base font, which is typically a hollow box.

The list of font links can be printed by using the ^LF command or retrieved with the ^HT command.



Examples • These examples show the code and output for no font linking and for font linking:

No Font Linking

In the no font linking example, the Swiss721 font does not have the Asian glyphs, which is why Asian glyphs do not print.

ZPL II CODE	GENERATED LABEL
<pre> ^XA^LL1200^CW1, E: SWISS721. TTF^CW2, E: ANMDJ. TTF^CI28^FS ^FO100, 100^A0, 50, 50^FDNO FONT LINKING^FS ^FO100, 300^A1, 50, 50^FDTEST WITH SWISS721^FS ^FO100, 400^A1, 50, 50^FDDRAGONFLY 蜻蜓^FS ^FO100, 600^A2, 50, 50^FDTEST WITH ANMDJ^FS ^FO100, 700^A2, 50, 50^FDDRAGONFLY 蜻蜓^FS ^XZ </pre>	<div style="border: 1px solid black; padding: 10px;"> <p>NO FONT LINKING</p> <p>TEST WITH SWISS721</p> <p>DRAGONFLY</p> <p>TEST WITH ANMDJ</p> <p>DRAGONFLY 蜻蜓</p> </div>

Font Linking

In the font linking example, this code is sent down to link the **ANMDJ.TTF** font to **SWISS721.TTF** font:

```
^XA
^FLE:ANMDJ.TTF,E:SWISS721.TTF,1^FS
^XZ
```

When the label reprints, the Asian characters are printed using the **ANMDJ.TTF** font, rather than the **SWISS721.TTF** font.

ZPL II CODE	GENERATED LABEL
<pre>^XA^LL1200^CW1,E:SWISS721.TTF^CW2,E:ANMDJ.TTF^CI28^FS ^FO100,100^A0,50,50^DFONT LINKING^FS ^FO100,300^A1,50,50^DTEST WITH SWISS721^FS ^FO100,400^A1,50,50^DDRAGONFLY 蜻蜓^FS ^FO100,600^A2,50,50^DTEST WITH ANMDJ^FS ^FO100,700^A2,50,50^DDRAGONFLY 蜻蜓^FS ^XZ</pre>	<div style="border: 1px solid black; padding: 10px;"> <p>FONT LINKING</p> <p>TEST WITH SWISS721</p> <p>DRAGONFLY 蜻蜓</p> <p>TEST WITH ANMDJ</p> <p>DRAGONFLY 蜻蜓</p> </div>

^FM – Multiple Field Origin Locations

Description The ^FM command allows you to control the placement of bar code symbols.

It designates field locations for the PDF417 (^B7) and MicroPDF417 (^BF) bar codes when the structured append capabilities are used. This allows printing multiple bar codes from the same set of text information.

The structured append capability is a way of extending the text printing capacity of both bar codes. If a string extends beyond what the data limitations of the bar code are, it can be printed as a series: 1 of 3, 2 of 3, 3 of 3. Scanners read the information and reconcile it into the original, unsegmented text.

The ^FM command triggers multiple bar code printing on the same label with ^B7 and ^BF only. When used with any other commands, it is ignored.

Format ^FMx1,y1,x2,y2,...

Parameters	Details
x1 = x-axis location of first symbol (in dots)	<p><i>Accepted Values:</i> 0 to 32000 e = exclude this bar code from printing</p> <p><i>Default Value:</i> a value must be specified</p>
y1 = y-axis location of first symbol (in dots)	<p><i>Accepted Values:</i> 0 to 32000 e = exclude this bar code from printing</p> <p><i>Default Value:</i> a value must be specified</p>
x2 = x-axis location of second symbol (in dots)	<p><i>Accepted Values:</i> 0 to 32000 e = exclude this bar code from printing</p> <p><i>Default Value:</i> a value must be specified</p>
y2 = y-axis location of second symbol (in dots)	<p><i>Accepted Values:</i> 0 to 32000 e = exclude this bar code from printing</p> <p><i>Default Value:</i> a value must be specified</p>
... = continuation of X,Y pairs	<i>Maximum number of pairs:</i> 60

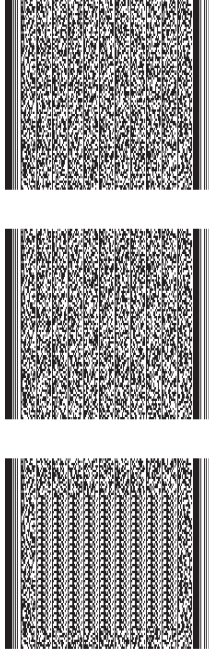

Example • This example shows you how to generate three bar codes with the text “Zebra Technologies Corporation strives to be...” would need to be repeated seven times, which includes 2870 characters of data (including spaces) between ^FD and ^FS:

ZPL II CODE	GENERATED LABEL
<pre> ^XA ^FM100,100,100,600,100,1200 ^BY2,3 ^B7N,5,5,9,83,N ^FDZebra Technologies Corporation strives to be the expert supplier of innovative solutions to specialty demand labeling and ticketing problems of business and government. We will attract and retain the best people who will understand our customer's needs and provide them with systems, hardware, software, consumables and service offering the best value, high quality, and reliable performance, all delivered in a timely manner ... ^FS^XZ </pre>	

1

1	The ellipse is not part of the code. It indicates that the text needs to be repeated seven times, as mentioned in the example description.
---	--



Example • This example assumes a maximum of three bar codes, with bar code 2 of 3 omitted:

ZPL II CODE	GENERATED LABEL
<pre> ^XA ^FM100,100,e,e,100,1200 ^BY2,3 ^B7N,5,5,9,83,N ^FDZebra Technologies Corporation strives to be the expert supplier of innovative solutions to specialty demand labeling and ticketing problems of business and government. We will attract and retain the best people who will understand our customer's needs and provide them with systems, hardware, software, consumables and service offering the best value, high quality, and reliable performance, all delivered in a timely manner ... ^FS^XZ </pre> <p style="text-align: right; margin-right: 20px;">1</p>	

1 The ellipse is not part of the code. It indicates that the text needs to be repeated seven times, as mentioned in the example description.

Comments Subsequent bar codes print once the data limitations of the previous bar code have been exceeded. For example, bar code 2 of 3 prints once 1 of 3 has reached the maximum amount of data it can hold. Specifying three fields does not ensure that three bar codes print; enough field data to fill three bar code fields has to be provided.

The number of the *x, y* pairs can exceed the number of bar codes generated. However, if too few are designated, no symbols print.

^FN – Field Number

Description The ^FN command numbers the data fields. This command is used in both ^DF (Store Format) and ^XF (Recall Format) commands.

In a stored format, use the ^FN command where you would normally use the ^FD (Field Data) command. In recalling the stored format, use ^FN in conjunction with the ^FD command.

The optional "a" parameter can be used with the KDU Plus to cause prompts to be displayed on the KDU unit. Also, when the Print on Label link is selected on the Directory page of ZebraLink enabled printers the field prompt displays.

The number of fields and data that can be stored is dependent in the available printer memory.



Note • The maximum number of ^FN commands that can be used depends on the amount of data that is placed in the fields on the label. It is recommended to use 400 or fewer fields.

Format ^FN#"a"

Parameters	Details
# = number to be assigned to the field	<i>Accepted Values:</i> 0 to 9999 <i>Default Value:</i> 0
"a" = optional parameter*	<i>Accepted Values:</i> 255 alphanumeric characters maximum (a-z,A-Z,1-9 and space) <i>Default Value:</i> optional parameter

* This parameter is only available on printers with firmware V50.13.2, V53.15.5Z, V60.13.0.1, or later. For a complete example of the ^DF and ^XF command, see [^DF and ^XF — Download format and recall format on page 56](#).

Comments

- The same ^FN value can be stored with several different fields.
- If a label format contains a field with ^FN and ^FD, the data in that field prints for any other field containing the same ^FN value.
- For the "a" parameter to function as a prompt the characters used in the "a" parameter must be surrounded by double quotes (see example).



Example • The ^FN1"Name" would result in "Name" being used as the prompt on the KDU unit.

^FO – Field Origin

Description The ^FO command sets a field origin, relative to the label home (^LH) position. ^FO sets the upper-left corner of the field area by defining points along the x-axis and y-axis independent of the rotation.

Format ^FO x,y,z

Parameters	Details
x = x-axis location (in dots)	<i>Accepted Values:</i> 0 to 32000 <i>Default Value:</i> 0
y = y-axis location (in dots)	<i>Accepted Values:</i> 0 to 32000 <i>Default Value:</i> 0
z = justification  The z parameter is only supported in firmware versions V60.14.x, V50.14.x, or later.	<i>Accepted Values:</i> 0 = left justification 1 = right justification 2 = auto justification (script dependent) <i>Default Value:</i> last accepted ^FW value or ^FW default

Comments If the value entered for the x or y parameter is too high, it could position the field origin completely off the label.



This command interacts with the field direction parameter of ^FP and with the rotation parameter of ^A. For output and examples, see [Field Interactions on page 1243](#).

The auto justification option might cause unexpected results if variable fields or bidirectional text are used with ^FO. For the best results with bidirectional text and/or variable fields, use either the left or right justification option.

^FP – Field Parameter

Description The ^FP command allows vertical and reverse formatting of the font field, commonly used for printing Asian fonts.

Format ^FPd,g

Parameters	Details
d = direction	<p><i>Accepted Values:</i></p> <ul style="list-style-type: none"> H = horizontal printing (left to right) V = vertical printing (top to bottom) R = reverse printing (right to left) <p><i>Default Value:</i> H</p>
g = additional inter-character gap (in dots)	<p><i>Accepted Values:</i> 0 to 9999</p> <p><i>Default Value:</i> 0 if no value is entered</p>



Example • This is an example of how to implement reverse and vertical print:

ZPL II CODE	GENERATED LABEL
<pre> ^XA ^FO100,50 ^FPV,10 ^AV ^FDvertical^FS ^XZ </pre>	
<pre> ^XA ^FO350,50 ^FPR,10 ^AV ^FDreverse^FS ^XZ </pre>	



For vertical and reverse printing directions, combining semantic clusters are used to place characters.

This command interacts with the justification parameters of ^FO and ^FT and with the rotation parameter of ^A. For output and examples, see [Field Interactions on page 1243](#).

^FR – Field Reverse Print

Description The ^FR command allows a field to appear as white over black or black over white. When printing a field and the ^FR command has been used, the color of the output is the reverse of its background.

Format ^FR

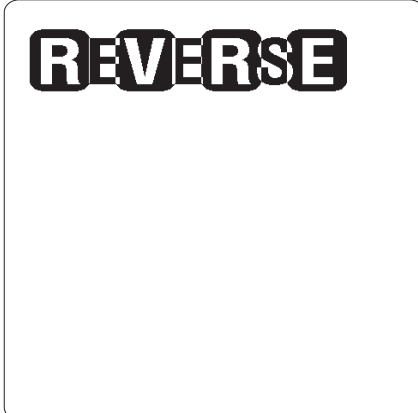

Example • In this example, the ^GB command creates areas of black allowing the printing to appear white:

ZPL II CODE	GENERATED LABEL
<pre>^XA ^PR1 ^FO100,100 ^GB70,70,70,,3^FS ^FO200,100 ^GB70,70,70,,3^FS ^FO300,100 ^GB70,70,70,,3^FS ^FO400,100 ^GB70,70,70,,3^FS ^FO107,110^CF0,70,93 ^FR^FDREVERSE^FS ^XZ</pre>	

Comments The ^FR command applies to only one field and has to be specified each time. When multiple ^FR commands are going to be used, it might be more convenient to use the ^LR command.

^FS – Field Separator

Description The ^FS command denotes the end of the field definition. Alternatively, ^FS command can also be issued as a single ASCII control code SI (Control-O, hexadecimal 0F).

Format ^FS

[^]FT – Field Typeset

Description The [^]FT command sets the field position, relative to the home position of the label designated by the [^]LH command. The typesetting origin of the field is fixed with respect to the contents of the field and does not change with rotation.



Note • The [^]FT command is capable of concatenation of fields.

Format [^]FT x,y,z

Parameters	Details
x = x-axis location (in dots)	<i>Accepted Values:</i> 0 to 32000 <i>Default Value:</i> position after last formatted text field
y = y-axis location (in dots)	<i>Accepted Values:</i> 0 to 32000 <i>Default Value:</i> position after last formatted text field
z = justification	<i>Accepted Values:</i> 0 = left justification 1 = right justification 2 = auto justification (script dependent) <i>Default Value:</i> last accepted [^] FW value or [^] FW default The auto justification option may cause unexpected results if variable fields or bidirectional text are used with [^] FT. For best results with bidirectional text and/or variable fields, use either the left or right justification options.

.141

The z parameter is only supported in firmware version V60.14.x, V50.14.x, or later.

Table 12 • Typeset Justification

Left Justified	Text	For examples, see Field Interactions on page 1243 .
	Bar Codes	Origin is base of bar code, at left edge
	Graphic Boxes	Origin is bottom-left corner of the box
	Images	Origin is bottom-left corner of the image area
Right Justified	Text	For examples, see Field Interactions on page 1243 .
	Bar Codes	Origin is base of bar code, at right edge
	Graphic Boxes	Origin is bottom-right corner of the box
	Images	Origin is bottom-right corner of the image area



Example • This is an example of the ^FT command and concatenation:

ZPL II CODE	GENERATED LABEL
<pre> ^XA ^FT10,200^A0N,30,20^FDACME ^FS ^FT^GS^FDC^FS ^FT^A0N,30,20^FDSummer ^FS ^FT^A0N,60,50^FDClearance ^FS ^FT^A0N,120,100^FDSale ^FS ^XZ </pre>	

When a coordinate is missing, the position following the last formatted field is assumed. This *remembering* simplifies field positioning with respect to other fields. Once the first field is positioned, other fields follow automatically.

There are several instances where using the ^FT command without specifying *x* and *y* parameters is not recommended:

- when positioning the first field in a label format
- at any time with the ^FN (Field Number) command
- following an ^SN (Serialization Data) command
- variable data
- bidirectional text



The right typeset justified is available only for printers with firmware version V60.14.x, V50.14.x, or later.

This command interacts with the field direction parameters of ^FP and with the rotation parameter of ^A. For output and code examples, see [Field Interactions on page 1243](#)

[^]FV – Field Variable

Description [^]FV replaces the [^]FD (field data) command in a label format when the field is variable.

Format [^]FVa

Parameters	Details
a = variable field data to be printed	Accepted Values: 0 to 3072 byte string Default Value: if no data is entered, the command is ignored



Example • This is an example of how to use the [^]MC and [^]FV command:

ZPL II CODE	GENERATED LABEL
<pre> [^]XA [^]FO40,40 [^]GB300,203,8[^]FS [^]FO55,60[^]CF0,25 [^]FVVARIABLE DATA #1[^]FS [^]FO80,150 [^]FDFIXED DATA[^]FS [^]MCN [^]XZ </pre>	
<pre> [^]XA [^]FO55,60[^]CF0,25 [^]FVVARIABLE DATA #2[^]FS [^]MCY [^]XZ </pre>	

Comments [^]FV fields are always cleared after the label is printed. [^]FD fields are not cleared.

^FW – Field Orientation

Description The ^FW command sets the default orientation for all command fields that have an orientation (rotation) parameter (and in x.14 sets the default justification for all commands with a justification parameter). Fields can be rotated 0, 90, 180, or 270 degrees clockwise by using this command. In x.14, justification can be left, right, or auto.

The ^FW command affects only fields that follow it. Once you have issued a ^FW command, the setting is retained until you turn off the printer or send a new ^FW command to the printer.

Format ^Fwr,z

Parameters	Details
r = rotate field	<p><i>Accepted Values:</i></p> <ul style="list-style-type: none"> N = normal R = rotated 90 degrees I = inverted 180 degrees B = bottom-up 270 degrees, read from bottom up <p><i>Initial Value at Power-up: N</i></p>
z = justification .141 The z parameter is available only with printers with firmware version V60.14.x, V50.14.x, or later.	<p><i>Accepted Values:</i></p> <ul style="list-style-type: none"> 0 = left justification 1 = right justification 2 = auto justification (script dependent) <p><i>Default Value:</i> auto for ^TB and left for all other commands</p>



Example • This example shows how ^FW rotation works in conjunction with ^FO. In this example, note that:

- the fields using A0N print the field in normal rotation
- the fields with no rotation indicated (A0) follow the rotation used in the ^FW command (^FWR).

ZPL II CODE	GENERATED LABEL
<pre> ^XA ^FWR ^FO150,90^A0N,25,20^FDZebra Technologies^FS ^FO115,75^A0,25,20^FD0123456789^FS ^FO150,115^A0N,25,20^FD333 Corporate Woods Parkway^FS ^FO400,75^A0,25,20^FDXXXXXXXXXX^FS ^XZ </pre>	

Comments ^FW affects only the orientation in commands where the rotation parameter has not been specifically set. If a command has a specific rotation parameter, that value is used.



^FW affects only the justification in commands where the parameter has not been set. If a command has a specific justification parameter that value is used .

^FX - Comment

Description The ^FX command is useful when you want to add *non-printing* informational comments or statements within a label format. Any data after the ^FX command up to the next caret (^) or tilde (~) command does not have any effect on the label format. Therefore, you should avoid using the caret (^) or tilde (~) commands within the ^FX statement.

Format ^FXc

Parameters	Details
c = non printing comment	Creates a non-printable comment.



Example • This is an example of how to use the ^FX command effectively:

ZPL II CODE	GENERATED LABEL
<pre> ^XA ^LH100,100^FS ^FXSHIPPING LABEL^FS ^FO10,10^GB470,280,4^FS ^FO10,190^GB470,4,4^FS ^FO10,80^GB240,2,2^FS ^FO250,10^GB2,100,2^FS ^FO250,110^GB226,2,2^FS ^FO250,60^GB226,2,2^FS ^FO156,190^GB2,95,2^FS ^FO312,190^GB2,95,2^FS ^XZ </pre>	

Comments Correct usage of the ^FX command includes following it with the ^FS command.

^GB – Graphic Box

Description The ^GB command is used to draw boxes and lines as part of a label format. Boxes and lines are used to highlight important information, divide labels into distinct areas, or to improve the appearance of a label. The same format command is used for drawing either boxes or lines.

Format ^GBw,h,t,c,r

Parameters	Details
w = box width (in dots)	<i>Accepted Values:</i> value of t to 32000 <i>Default Value:</i> value used for thickness (t) or 1
h = box height (in dots)	<i>Accepted Values:</i> value of t to 32000 <i>Default Value:</i> value used for thickness (t) or 1
t = border thickness (in dots)	<i>Accepted Values:</i> 1 to 32000 <i>Default Value:</i> 1
c = line color	<i>Accepted Values:</i> B = black W = white <i>Default Value:</i> B
r = degree of corner-rounding	<i>Accepted Values:</i> 0 (no rounding) to 8 (heaviest rounding) <i>Default Value:</i> 0

For the **w** and **h** parameters, keep in mind that printers have a default of 6, 8, 12, or 24 dots/millimeter. This comes out to 153, 203, 300, or 600 dots per inch. To determine the values for **w** and **h**, calculate the dimensions in millimeters and multiply by 6, 8, 12, or 24.

If the width and height are not specified, you get a solid box with its width and height as specified by value **t**.

The roundness-index is used to determine a rounding-radius for each box. Formula:

$$\text{rounding-radius} = (\text{rounding-index} / 8) * (\text{shorter side} / 2)$$

where the shorter side is the lesser of the width and height (after adjusting for minimum and default values).



Examples • Here are a few examples of graphic boxes:

Width: 1.5 inch; Height: 1 inch; Thickness: 10; Color: default; Rounding: default

ZPL II CODE	GENERATED LABEL
<pre> ^XA ^FO50,50 ^GB300,200,10^FS ^XZ </pre>	

Width: 0 inch; Height: 1 inch; Thickness: 20; Color: default; Rounding: default:

ZPL II CODE	GENERATED LABEL
<pre> ^XA ^FO50,50 ^GB0,203,20^FS ^XZ </pre>	

Width: 1 inch; Height: 0 inch; Thickness: 30; Color: default; Rounding: default

ZPL II CODE	GENERATED LABEL
<pre> ^XA ^FO50,50 ^GB203,0,20^FS ^XZ </pre>	

Width: 1.5 inch; Height: 1 inch; Thickness: 10; Color: default; Rounding: 5

ZPL II CODE	GENERATED LABEL
<pre> ^XA ^FO50,50 ^GB300,200,10,,5^FS ^XZ </pre>	

^GC – Graphic Circle

Description The ^GC command produces a circle on the printed label. The command parameters specify the diameter (width) of the circle, outline thickness, and color. Thickness extends inward from the outline.

Format ^GCd,t,c

Parameters	Details
d = circle diameter (in dots)	<i>Accepted Values: 3 to 4095</i> (larger values are replaced with 4095) <i>Default Value: 3</i>
t = border thickness (in dots)	<i>Accepted Values: 2 to 4095</i> <i>Default Value: 1</i>
c = line color	<i>Accepted Values:</i> B = black W = white <i>Default Value: B</i>



Example • This is an example of how to create a circle on the printed label:

ZPL II CODE	GENERATED LABEL
<pre> ^XA ^FO50,50 ^GC250,10,B^FS ^XZ </pre>	

^GD – Graphic Diagonal Line

Description The ^GD command produces a straight diagonal line on a label. This can be used in conjunction with other graphic commands to create a more complex figure.

Format ^GDw,h,t,c,o

Parameters	Details
w = box width (in dots)	<i>Accepted Values:</i> 3 to 32000 <i>Default Value:</i> value of t (thickness) or 3
h = box height (in dots)	<i>Accepted Values:</i> 3 to 32000 <i>Default Value:</i> value of t (thickness) or 3
t = border thickness (in dots)	<i>Accepted Values:</i> 1 to 32000 <i>Default Value:</i> 1
c = line color	<i>Accepted Values:</i> B = black W = white <i>Default Value:</i> B
o = orientation (direction of the diagonal)	<i>Accepted Values:</i> R (or /) = right-leaning diagonal L (or \) = left-leaning diagonal <i>Default Value:</i> R



Example • This is an example of how to create a diagonal line connecting one corner with the opposite corner of a box on a printed label:

ZPL II CODE	GENERATED LABEL
<pre> ^XA ^FO150,100 ^GB350,203,10^FS ^FO155,110 ^GD330,183,10,,R^FS ^XZ </pre>	

^GE – Graphic Ellipse

Description The ^GE command produces an ellipse in the label format.

Format ^GEw,h,t,c

Parameters	Details
w = ellipse width (in dots)	<i>Accepted Values:</i> 3 to 4095 (larger values are replaced with 4095) <i>Default Value:</i> value used for thickness (t) or 1
h = ellipse height (in dots)	<i>Accepted Values:</i> 3 to 4095 <i>Default Value:</i> value used for thickness (t) or 1
t = border thickness (in dots)	<i>Accepted Values:</i> 2 to 4095 <i>Default Value:</i> 1
c = line color	<i>Accepted Values:</i> B = black W = white <i>Default Value:</i> B



Example • This is an example of how to create an ellipse on a printed label:

ZPL II CODE	GENERATED LABEL
<pre> ^XA ^FO100,100 ^GE300,100,10,B^FS ^XZ </pre>	

^GF – Graphic Field

Description The ^GF command allows you to download graphic field data directly into the printer’s bitmap storage area. This command follows the conventions for any other field, meaning a field orientation is included. The graphic field data can be placed at any location within the bitmap space.

Format ^GFa,b,c,d,data

Parameters	Details
a = compression type	<p><i>Accepted Values:</i></p> <ul style="list-style-type: none"> A = ASCII hexadecimal (follows the format for other download commands) B = binary (data sent after the c parameter is strictly binary) C = compressed binary (data sent after the c parameter is in compressed binary format. The data is compressed on the host side using Zebra’s compression algorithm. The data is then decompressed and placed directly into the bitmap.) <p><i>Default Value:</i> A</p>
b = binary byte count	<p><i>Accepted Values:</i> 1 to 99999</p> <p>This is the total number of bytes to be transmitted for the total image or the total number of bytes that follow parameter d. For ASCII download, the parameter should match parameter c. Out-of-range values are set to the nearest limit.</p> <p><i>Default Value:</i> command is ignored if a value is not specified</p>
c = graphic field count	<p><i>Accepted Values:</i> 1 to 99999</p> <p>This is the total number of bytes comprising the graphic format (width x height), which is sent as parameter d. Count divided by bytes per row gives the number of lines in the image. This number represents the size of the image, not necessarily the size of the data stream (see d).</p> <p><i>Default Value:</i> command is ignored if a value is not specified</p>
d = bytes per row	<p><i>Accepted Values:</i> 1 to 99999</p> <p>This is the number of bytes in the downloaded data that comprise one row of the image.</p> <p><i>Default Value:</i> command is ignored if a value is not specified</p>
data = data	<p><i>Accepted Values:</i></p> <p>ASCII hexadecimal data: 00 to FF</p> <p>A string of ASCII hexadecimal numbers, two digits per image byte. CR and LF can be inserted as needed for readability. The number of two-digit number pairs must match the above count. Any numbers sent after count is satisfied are ignored. A comma in the data pads the current line with 00 (white space), minimizing the data sent. ~DN or any caret or tilde character prematurely aborts the download.</p> <p>Binary data: Strictly binary data is sent from the host. All control prefixes are ignored until the total number of bytes needed for the graphic format is sent.</p>

→ **Example** • This example downloads 8,000 total bytes of data and places the graphic data at location 100,100 of the bitmap. The data sent to the printer is in ASCII form.

```
^F0100,100^GFA,8000,8000,80,ASCII data
```

→ **Example** • This example downloads 8,000 total bytes of data and places the graphic data at location 100,100 of the bitmap. The data sent to the printer is in binary form.

```
^F0100,100^GFB,8000,8000,80,Binary data
```

^GS – Graphic Symbol

Description The ^GS command enables you to generate the registered trademark, copyright symbol, and other symbols.

Format ^GS_{o,h,w}

Parameters	Details
o = field orientation	<p><i>Accepted Values:</i></p> <ul style="list-style-type: none"> N = normal R = rotate 90 degrees clockwise I = inverted 180 degrees B = bottom-up, 270 degrees <p><i>Default Value:</i> N or last ^FW value</p>
h = character height proportional to width (in dots)	<p><i>Accepted Values:</i> 0 to 32000</p> <p><i>Default Value:</i> last ^CF value</p>
w = character width proportional to height (in dots)	<p><i>Accepted Values:</i> 0 to 32000</p> <p><i>Default Value:</i> last ^CF value</p>

➔ **Example** • Use the ^GS command followed by ^FD and the appropriate character (A through E) within the field data to generate the desired character:

ZPL II CODE	GENERATED LABEL
<pre> ^XA^CFD ^FO50,50 ^FDZEBRA PROGRAMMING^FS ^FO50,75 ^FDLANGUAGE II (ZPL II)^FS ^FO280,75 ^GS^FDC^FS ^XZ </pre>	<p>ZEBRA PROGRAMMING LANGUAGE II (ZPL IITM)</p>

A = ® (Registered Trade Mark)

B = © (Copyright)

C = ™ (Trade Mark)

D =  (Underwriters Laboratories approval)

E =  (Canadian Standards Association approval)

~HB – Battery Status

Description When the ~HB command is sent to the printer, a data string is sent back to the host. The string starts with an <STX> control code sequence and terminates by an <ETX><CR><LF> control code sequence.



Important • This command only responds to mobile printers.

Format ~HB

Parameters: when the printer receives the command, it returns:

<STX>bb.bb, hh.hh, bt<ETX><CR><LF>

<STX>	=	ASCII start-of-text character
bb.bb	=	current battery voltage reading to the nearest 1/4 volt
hh.hh	=	current head voltage reading to the nearest 1/4 volt
bt	=	battery temperature in Celsius
<ETX>	=	ASCII end-of-text character
<CR>	=	ASCII carriage return
<LF>	=	ASCII line feed character

Comments This command is used for the power-supply battery of the printer and should not be confused with the battery backed-up RAM.

~HD - Head Diagnostic

Description The ~HD command echoes printer status information that includes the power supply and head temperature using the terminal emulator.

Format ~HD



Example • This is an example of the ~HD command:

```
Head Temp = 29
Ambient Temp = 00
Head Test = Passed
Darkness Adjust = 23
Print Speed = 2
Slew Speed = 6
Backfeed Speed = 2
Static_pitch_length = 0521
Dynamic_pitch_length = 0540
Max_dynamic_pitch_length = 0540
Min_dynamic_pitch_length = 0537
COMMAND PFX = ~ : FORMAT PFX = ^ : DELIMITER = ,
P30 INTERFACE = None
P31 INTERFACE = None
P32 INTERFACE = Front Panel           Revision 5
P33 INTERFACE = None
P34 INTERFACE = None
P35 INTERFACE = None
Dynamic_top_position = 0008
No ribbon A/D = 0000
```

^HF – Host Format

Description The ^HF command sends stored formats to the host.

Format ^HFd,o,x

Parameters	Details
d = device to recall image	<i>Accepted Values:</i> R:, E:, B:, and A: <i>Default Value:</i> R:
o = image name	<i>Accepted Values:</i> 1 to 8 alphanumeric characters <i>Default Value:</i> if a name is not specified, UNKNOWN is used
x = extension	<i>Fixed Value:</i> .ZPL



Example • This example shows the sequence and results.

Using a terminal emulator, you download this code to the printer:

```

^XA
^DFB:FILE1.ZPL
^F0100,100^A0,100
^FDTEST^FS
^XZ

```

Then you send this code to the printer:

```

^XA
^HFB:FILE1.ZPL
^XZ

```

The terminal emulator returns this code:

```

^XA^DFFILE1,
^F0100,100^A0,100^FDTEST^FS
^XZ

```

^HG – Host Graphic

Description The ^HG command is used to upload graphics to the host. The graphic image can be stored for future use, or it can be downloaded to any Zebra printer.

Format ^HGd:o.x

Parameters	Details
d = device location of object	<i>Accepted Values:</i> R:, E:, B:, and A: <i>Default Value:</i> search priority
o = object name	<i>Accepted Values:</i> 1 to 8 alphanumeric characters <i>Default Value:</i> if a name is not specified, UNKNOWN is used
x = extension	<i>Fixed Value:</i> .GRF

Comments For more information on uploading graphics, see [^HY on page 241](#).

^HH - Configuration Label Return

Description The ^HH command echoes printer configuration back to the host, using a terminal emulator.

Format ^HH



Example • This is an example of what is returned to the host when ^XA^HH^XZ is sent to the printer:

```

+10          DARKNESS
+000         TEAR OFF
TEAR OFF    PRINT MODE
NON-CONTINUOUS MEDIA TYPE
WEB         SENSOR TYPE
DIRECT-THERMAL PRINT METHOD
050 6/8 MM  PRINT WIDTH
0622       LABEL LENGTH
22.0IN    557MM  MAXIMUM LENGTH
9600      BAUD
8 BITS    DATA BITS
NONE      PARITY
XON/XOFF  HOST HANDSHAKE
NONE      PROTOCOL
000       NETWORK ID
NORMAL MODE COMMUNICATIONS
<^> 7EH   CONTROL PREFIX
<^> 5EH   FORMAT PREFIX
<.> 2CH   DELIMITER CHAR
ZPL II     ZPL MODE
NO MOTION  MEDIA POWER UP
NO MOTION  HEAD CLOSE
DEFAULT    BACKFEED
+000       LABEL TOP
+0000      LEFT POSITION
026        WEB S.
068        MEDIA S.
050        MARK S.
001        MARK MED S.
CS         MODES ENABLED
..         MODES DISABLED
864 8/MM FULL RESOLUTION
U32.10.2 <-  FIRMWARE
U2.2.6.98.A  HARDWARE ID
CUSTOMIZED  CONFIGURATION
1024.....R: RAM
8192.....B: MEMORY CARD
0768.....E: ONBOARD FLASH
NONE       FORMAT CONVERT
NONE       OPTION
05/14/03   RTC DATE
02:23     RTC TIME
DYNAMIC    IP RESOLUTION
ALL        IP PROTOCOL
010.003.005.090 IP ADDRESS
255.255.255.000 SUBNET MASK
010.003.005.001 DEFAULT GATEWAY

```

~HI - Host Identification

Description The ~HI command is designed to be sent from the host to the Zebra printer to retrieve information. Upon receipt, the printer responds with information on the model, software version, dots-per-millimeter setting, memory size, and any detected options.

Format ~HI

When the printer receives this command, it returns:

XXXXXX,V1.0.0,dpm,000KB,X

XXXXXX = model of Zebra printer

V1.0.0 = version of software

dpm = dots/mm

6, 8, 12, or 24 dots/mm printheads

000KB = memory

512KB = 1/2 MB

1024KB = 1 MB

2048KB = 2 MB

4096KB = 4 MB

8192KB = 8 MB

x = recognizable options

only options specific to printer are shown (cutter, options, et cetera.)

~HQ – Host Query

Description The ~HQ command group causes the printer to send information back to the host.

Supported Devices

- Xi4, RXi4
- ZM400/ZM600 with v53.17.1Z or later, RZ400/RZ600
- S4M with v53.17.1Z or later
- G-Series with v56.16.5 or later
or
G-Series with v61.16.5 or later

Format ~HQquery-type

Parameter	Details
query-type	<p>For detailed examples of these parameters, see ~HQ Examples on page 227.</p> <p><i>Accepted Values:</i></p> <ul style="list-style-type: none"> ES = requests the printer’s status - see Table 13 on page 225 and Table 14 on page 226 HA = hardware address of the internal wired print server JT = requests a summary of the printer’s printhead test results MA = maintenance alert settings MI = maintenance information OD = odometer PH = printhead life history PP = printer’s Plug and Play string SN = printer’s serial number UI = USB product ID and BDC release version <p><i>Default Value:</i> must be an accepted value or the command is ignored</p>

Comments The response to the ~HQ command starts with STX, a CR LF is inserted between each line, and the response ends with ETX.

Table 13 • Error Flags (~HQES)

Error Flags	Flag	Group 2	Group 1 (X = Value can be any hexadecimal number [0-9, A-F])							
		Nibbles16 -9	Nibble 8	Nibble 7	Nibble 6	Nibble 5	Nibble 4	Nibble 3	Nibble 2	Nibble 1
No Error	0	00000000	0	0	0	0	0	0	0	0
Error Present	1	00000000	X	X	X	X	X	X	X	X
Printhead Thermistor Open	1	00000000	X	X	X	X	X	2	X	X
Invalid Firmware Config.	1	00000000	X	X	X	X	X	1	X	X
Printhead Detection Error	1	00000000	X	X	X	X	X	X	8	X
Bad Printhead Element	1	00000000	X	X	X	X	X	X	4	X
Motor Over Temperature	1	00000000	X	X	X	X	X	X	2	X
Printhead Over Temperature	1	00000000	X	X	X	X	X	X	1	X
Cutter Fault	1	00000000	X	X	X	X	X	X	X	8
Head Open	1	00000000	X	X	X	X	X	X	X	4
Ribbon Out	1	00000000	X	X	X	X	X	X	X	2
Media Out	1	00000000	X	X	X	X	X	X	X	1
Clear Paper Path Failed ^a	1 ^a	00000000	X	X	X	X	8 ^a	X	X	X
Paper Feed Error ^a	1 ^a	00000000	X	X	X	X	4 ^a	X	X	X
Presenter Not Running ^a	1 ^a	00000000	X	X	X	X	2 ^a	X	X	X
Paper Jam during Retract ^a	1 ^a	00000000	X	X	X	X	1 ^a	X	X	X
Black Mark not Found ^a	1 ^a	00000000	X	X	X	8 ^a	X	X	X	X
Black Mark Calabrate Error ^a	1 ^a	00000000	X	X	X	4 ^a	X	X	X	X
Retract Function timed out ^a	1 ^a	00000000	X	X	X	2 ^a	X	X	X	X
Paused ^a	1 ^a	00000000	X	X	X	1 ^a	X	X	X	X

a. This error flag is supported only on KR403 printers.

Table 14 • Warning Flags (~HQES)

Error Flags	Flag	Group 2	Group 1 (X = Value can be any hexadecimal number [0-9, A-F])								
		Nibbles16 -9	Nibble 8	Nibble 7	Nibble 6	Nibble 5	Nibble 4	Nibble 3	Nibble 2	Nibble 1	
No Warning	0	00000000	0	0	0	0	0	0	0	0	0
Warning Present	1	00000000	X	X	X	X	X	X	X	X	X
Paper-near-end Sensor ^b	1 ^b	00000000	X	X	X	X	X	X	X	X	8 ^b
Replace Printhead	1	00000000	X	X	X	X	X	X	X	X	4
Clean Printhead	1	00000000	X	X	X	X	X	X	X	X	2
Need to Calibrate Media	1	00000000	X	X	X	X	X	X	X	X	1
Sensor 1 (Paper before head) ^b	1 ^b	00000000	X	X	X	X	X	X	X	1 ^b	X
Sensor 2 (Black mark) ^b	1 ^b	00000000	X	X	X	X	X	X	X	2 ^b	X
Sensor 3 (Paper after head) ^b	1 ^b	00000000	X	X	X	X	X	X	X	4 ^b	X
Sensor 4 (loop ready) ^b	1 ^b	00000000	X	X	X	X	X	X	X	8 ^b	X
Sensor 5 (presenter) ^b	1 ^b	00000000	X	X	X	X	X	X	1 ^b	X	X
Sensor 6 (retract ready) ^b	1 ^b	00000000	X	X	X	X	X	X	2 ^b	X	X
Sensor 7 (in retract) ^b	1 ^b	00000000	X	X	X	X	X	X	4 ^b	X	X
Sensor 8 (at bin) ^b	1 ^b	00000000	X	X	X	X	X	X	8 ^b	X	X

b. This error flag is supported only on KR403 printers.

~HQ Examples

This section provides detail examples of all the available parameters.



Example 1 • This example shows how to request the printer's status.

- a. To request the printer's status, type `~HQES`
The printer responds with data similar to this:

```
PRINTER STATUS
  ERRORS:          1 00000000 00000005
  WARNINGS:        1 00000000 00000002
```

In this example, the Printer Status resolves to these conditions:

- The cover/printhead is open (value = 4).
- Media is out or not loaded into the printer (value = 1).
- The printhead needs to be cleaned (value = 2).
- Error nibble 1 is equal to 5 when the error status values are added together (4 + 1).

This illustration identifies the printer status definitions:

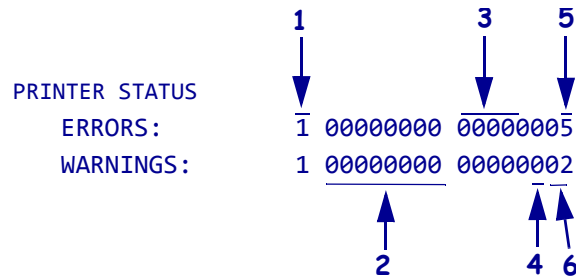

1	Flag
2	Nibble 16-9
3	Nibble 8-4
4	Nibble 3
5	Nibble 2
6	Nibble 1



Example 2 • This example shows how the printer responds when the printer receives the ~HQES command:

- a. To see how the printer responds, type ~HQES

The printer responds with data similar to this:

```
PRINTER STATUS
  ERRORS:   1 00000000 0000000B
  WARNINGS: 0 00000000 00000000
```

In this example, the printer status resolves to the following conditions:

- The cutter has a fault (value = 8).
- Ribbon is out or not loaded into the printer (value = 2).
- Media is out or not loaded into the printer (value = 1).
- Error byte 1 is equal to B when the error status values are added together (8 + 2 + 1 = hexadecimal B).



Example 3 • This is an example of how to retrieve the hardware address of the internal wired print server.

- a. To get the hardware address of the internal wired print server, type ~HQHA

The printer responds with data similar to this:

```
MAC ADDRESS
00:07:4d:2c:e0:7a
```



Example 4 • This is an example of how to request a summary of the printer's printhead test results.

The ^JT command is used to initiate printhead testing, set the testing interval, and set the element range to be tested. For more details see, [^JT on page 276](#).

- a. To request a summary of the printer's printhead test, type ~HQJT

The printer responds with data similar to this:

```
PRINT HEAD TEST RESULTS
0,A,0000,0000,0000
```

When the printer has printed enough labels to trigger a printhead test, the initial data changes.

- b. To request a summary of the printer's printhead test, type ~HQJT

The printer responds with data similar to this:

```
PRINT HEAD TEST RESULTS:
0,A,0015,0367,0000
```

This illustration identifies the printhead test field definitions:

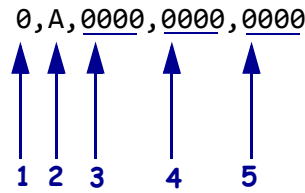

1	Element failure
2	Manual (M) or automatic (A) range
3	First test element
4	Last test element
5	Failure count



Example 5 • This is an example of how to use the maintenance alert query for the ~HQ command.

- a. To get the current settings, type ~HQMA
The printer responds with data similar to this:

```
~HQMA
MAINTENANCE ALERT SETTINGS
HEAD REPLACEMENT INTERVAL:      1 km
HEAD REPLACEMENT FREQUENCY:     0 M
HEAD CLEANING INTERVAL:         0 M
HEAD CLEANING FREQUENCY:        0 M
PRINT REPLACEMENT ALERT:        NO
PRINT CLEANING ALERT:           NO
UNITS:                           C
```



Example 6 • This is an example of how to use the maintenance information query for the ~HQ command. Note that the message is controlled by the ^MI command.

- a. To get the current settings, type ~HQMI
The printer responds with data similar to this:

```
MAINTENANCE ALERT MESSAGES ← 1
CLEAN: PLEASE CLEAN PRINT HEAD |
REPLACE: PLEASE REPLACE PRINT HEAD | ← 2
```



Example 7 • This is an example of how to use the odometer query for the ~HQ command. Note that the units of measure are controlled by the ^MA command. Also, if the "Early Warning Maintenance State" is turned "ON" the printer response would also list LAST CLEANED and CURRENT PRINTHEAD LIFE counters.

- a. To get the current settings, type ~HQOD

The printer responds with data similar to this:

```
PRINT METERS
TOTAL NONRESETTABLE:      8560 "
USER RESETTABLE CNTR1:    9 "
USER RESETTABLE CNTR2:    8560 "
```

The units of measure are set to inches.

- b. To change the units of measure to centimeters, type:

```
^XA^MA,,,C
^XZ
```

The units of measure are set to centimeters.

- c. To check the settings, type ~HQOD

The printer responds with data similar to this:

```
PRINT METERS
TOTAL NONRESETTABLE:      21744 cm
USER RESETTABLE CNTR1:    24 cm
USER RESETTABLE CNTR2:    21744 cm
```



Example 8 • This is an example of how to use the printhead life query for the ~HQ command. Note that the units of measure are controlled by the ^MA command.

- a. To get the current settings, type ~HQPH

The printer responds with data similar to this:

```
LAST CLEANED: 257 "
HEAD LIFE HISTORY
#  DISTANCE
1:    257 "
2:   1489 "
3:   7070 "
```

1	The current life of the print head.
2	Line items 2 through 10 (the example only shows 2 through 3) tracks the measurement for each time the print head is changed.

→ **Example 9** • This is an example of how to request the printer's Plug and Play string.

- a. To request the printer's Plug and Play string, type `~HQPP`

The printer responds with data similar to this:

```
PLUG AND PLAY MESSAGES
MFG: Zebra Technologies
CMD: ZPL
MDL: GX420t
```

→ **Example 10** • This is an example of how to retrieve the printer's serial number.

- a. To get the printer's serial number, type `~HQSN`

The printer responds with data similar to this:

```
SERIAL NUMBER
41A06440023
```

→ **Example 11** • This is an example of how to retrieve the printer's USB product ID and BCD release version.

- a. To get the printer's USB product ID and BCD release version, type `~HQUI`

The printer responds with data similar to this:

```
USB INFORMATION
PID: 0085
RELEASE VERSION: 15.01
```

~HS – Host Status Return

Description When the host sends ~HS to the printer, the printer sends three data strings back. Each string starts with an <STX> control code and is terminated by an <ETX><CR><LF> control code sequence. To avoid confusion, the host prints each string on a separate line.



Note • When a ~HS command is sent the printer will not send a response to the host if the printer is in one of these conditions:

- MEDIA OUT
- RIBBON OUT
- HEAD OPEN
- REWINDER FULL
- HEAD OVER-TEMPERATURE

String 1 <STX>aaa,b,c,dddd,eee,f,g,h,iii,j,k,l<ETX><CR><LF>

aaa	=	communication (interface) settings ^a
b	=	paper out flag (1 = paper out)
c	=	pause flag (1 = pause active)
dddd	=	label length (value in number of dots)
eee	=	number of formats in receive buffer
f	=	<i>buffer full</i> flag (1 = receive buffer full)
g	=	<i>communications diagnostic mode</i> flag (1 = diagnostic mode active)
h	=	<i>partial format</i> flag (1 = partial format in progress)
iii	=	unused (always 000)
j	=	<i>corrupt RAM</i> flag (1 = configuration data lost)
k	=	temperature range (1 = under temperature)
l	=	temperature range (1 = over temperature)

- a.** This string specifies the printer's baud rate, number of data bits, number of stop bits, parity setting, and type of handshaking. This value is a three-digit decimal representation of an eight-bit binary number. To evaluate this parameter, first convert the decimal number to a binary number.

The nine-digit binary number is read according to this table:

aaa = a ⁸ a ⁷ a ⁶ a ⁵ a ⁴ a ³ a ² a ¹ a ⁰	
a ⁷ = Handshake 0 = Xon/Xoff 1 = DTR	a ⁸ a ² a ¹ a ⁰ = Baud 0 000 = 110 0 001 = 300 0 010 = 600 0 011 = 1200 0 100 = 2400 0 101 = 4800 0 110 = 9600 0 111 = 19200
a ⁶ = Parity Odd/Even 0 = Odd 1 = Even	1 000 = 28800 <i>(available only on certain printer models)</i> 1 001 = 38400 <i>(available only on certain printer models)</i> 1 010 = 57600 <i>(available only on certain printer models)</i> 1 011 = 14400
a ⁵ = Disable/Enable 0 = Disable 1 = Enable	
a ⁴ = Stop Bits 0 = 2 Bits 1 = 1 Bit	
a ³ = Data Bits 0 = 7 Bits 1 = 8 Bits	

String 2 <STX>mmm,n,o,p,q,r,s,t,uuuuuuuu,v,www<ETX><CR><LF>

mmm	=	function settings ^b
n	=	unused
o	=	<i>head up</i> flag (1 = head in up position)
p	=	<i>ribbon out</i> flag (1 = ribbon out)
q	=	<i>thermal transfer mode</i> flag (1 = Thermal Transfer Mode selected)
r	=	Print Mode
		0 = Rewind
		1 = Peel-Off
		2 = Tear-Off
		3 = Cutter
		4 = Applicator
		5 = Delayed cut
		6 = Linerless Peel
		7 = Linerless Rewind
		8 = Partial Cutter
		9 = RFID
		K = Kiosk
		S = Stream
s	=	print width mode
t	=	<i>label waiting</i> flag (1 = label waiting in Peel-off Mode)
uuuuuuuu	=	labels remaining in batch
v	=	<i>format while printing</i> flag (always 1)
www	=	number of graphic images stored in memory



Values 4 to 5 are only supported in firmware version V60.14.x, V50.14.x, V53.15.x, or later.

- b.** This string specifies the printer's media type, sensor profile status, and communication diagnostics status. As in String 1, this is a three-digit decimal representation of an eight-bit binary number. First, convert the decimal number to a binary number.
- c.** These values are only supported on the ZE500, Xi4, RXi4, ZM400/ZM600, and RZ400/RZ600 printers.

The eight-digit binary number is read according to this table:

mmm = m7 m6 m5 m4 m3 m2 m1 m0							
m7 = Media Type 0 = Die-Cut 1 = Continuous				m4 m3 m2 m1 = Unused 0 = Off 1 = On			
m6 = Sensor Profile 0 = Off				m0 = Print Mode 0 = Direct Thermal 1 = Thermal Transfer			
m5 = Communications Diagnostics 0 = Off 1 = On							

String 3 <STX>xxxx,y<ETX><CR><LF>

xxxx = password

y = 0 (static RAM not installed)

1 (static RAM installed)

^HT – Host Linked Fonts List



This command is available only for printers with firmware version V60.14.x, V50.14.x, or later.

Description The ^HT command receives the complete list of font links over a communication port.



Example • The `SWISS.721.TTF` is the base font, `ANMDJ.TTF` is the first linked font, and `MSGOTHIC.TTF` is the second linked font:

ZPL II CODE	DATA RETURNED
<pre> ^XA ^HT ^XZ </pre>	<pre> LIST OF FONT LINKS E:SWISS721.TTF E:ANMDJ.TTF E:MSGOTHIC.TTF </pre>

This is the code that was used to establish the font links:

```

^XA
^FLE:ANMDJ.TTF,E:SWISS721.TTF,1^FS
^FLE:MSGOTHIC.TTF,E:SWISS721.TTF,1^FS
^XZ
    
```

~HU – Return ZebraNet Alert Configuration

Description This command returns the table of configured ZebraNet Alert settings to the host.

Format ~HU



Example • If the ~HU command is sent to the printer with existing Alert messages set to go to e-mail and SNMP traps, the data returned would look something like the information below. See [^SX on page 356](#) for complete information on the individual parameter settings.

```
B,C,Y,Y,ADMIN@COMPANY.COM,0
J,F,Y,Y,,0
C,F,Y,Y,,0
D,F,Y,Y,,0
E,F,Y,N,,0
F,F,Y,N,,0
H,C,Y,N,ADMIN@COMPANY.COM,0
N,C,Y,Y,ADMIN@COMPANY.COM,0
O,C,Y,Y,ADMIN@COMPANY.COM,0
P,C,Y,Y,ADMIN@COMPANY.COM,0
```



Important • If there are no ^SX (alerts) set, the printer will not respond to the ~HU command.

The first line indicates that condition B (ribbon out) is routed to destination C (e-mail address).

The next two characters, Y and Y, indicate that the *condition set* and *condition clear* options have been set to **yes**.

The following entry is the destination that the Alert e-mail should be sent to; in this example it is **admin@company.com**.

The last figure seen in the first line is 0, which is the port number.

Each line shows the settings for a different Alert condition as defined in the ^SX command.

^HV – Host Verification

Description Use this command to return data from specified fields, along with an optional ASCII header, to the host computer. You can use this command with any field that has been assigned a number with the ^RT command or with the ^FN and ^RF commands.

Format ^HV#,n,h,t,a

This table identifies the parameters for this format:

Parameters	Details
# = field number specified with another command	The value assigned to this parameter should be the same as the one used in another command. <i>Accepted Values:</i> 0 to 9999 <i>Default Value:</i> 0
n = number of bytes to be returned	<i>Accepted Values:</i> 1 to 256 <i>Default Value:</i> 64
h = header to be returned with the data	Delimiter characters terminate the string. This field is Field Hex (^FH) capable. <i>Accepted Values:</i> 0 to 3072 bytes <i>Default Value:</i> no header
t = termination	This field is Field Hex (^FH) capable. <i>Accepted Values:</i> 0 to 3072 characters
a = command applies to	When ^PQ is greater than 1 or if a void label occurs, send one response for a label format or one for every label printed. <i>Accepted Values:</i> F = Format L = Label <i>Default Value:</i> F



Example • The following code:

```
^XA
.
.
.
^FH_ ^HV0,8,EPC[, ]_0D_0A,L^FS
^PQ2
^XZ
```

Would return data such as this:

```
EPC[12345678]
EPC[55554444]
```

^HW – Host Directory List

Description ^HW is used to transmit a directory listing of objects in a specific memory area (storage device) back to the host device. This command returns a formatted ASCII string of object names to the host.

Each object is listed on a line and has a fixed length. The total length of a line is also fixed. Each line listing an object begins with the asterisk (*) followed by a blank space. There are eight spaces for the object name, followed by a period and three spaces for the extension. The extension is followed by two blank spaces, six spaces for the object size, two blank spaces, and three spaces for option flags (reserved for future use). The format looks like this:

```
<STX><CR><LF>
DIR R: <CR><LF>
*Name.ext(2sp.)(6 obj. sz.)(2sp.)(3 option flags)
*Name.ext(2sp.)(6 obj. sz.)(2sp.)(3 option flags)
<CR><LF>
-xxxxxxx bytes free
<CR><LF>
<ETX>
<STX> = start of text
<CR><LR> = carriage return/line feed
<ETX> = end on text
```

The command might be used in a stand-alone file to be issued to the printer at any time. The printer returns the directory listing as soon as possible, based on other tasks it might be performing when the command is received.

This command, like all ^ (caret) commands, is processed in the order that it is received by the printer.

Format ^HWd:o.x

Parameters	Details
d = location to retrieve object listing	<i>Accepted Values:</i> R:, E:, B:, A: and Z: <i>Default Value:</i> R:
o = object name	<i>Accepted Values:</i> 1 to 8 alphanumeric characters <i>Default Value:</i> asterisk (*). A question mark (?) can also be used.
x = extension	<i>Accepted Values:</i> any extension conforming to Zebra conventions <i>Default Value:</i> asterisk (*). A question mark (?) can also be used.

Parameters	Details
<p>f = format</p> <div data-bbox="204 373 266 436" style="border: 1px solid black; padding: 2px; width: fit-content; margin: 10px 0;">.16†</div> <p>The f parameter is only supported in firmware version V60.16.0Z and V53.16.0Z or later.</p>	<p><i>Accepted Values:</i></p> <ul style="list-style-type: none"> c = column format d = default format <p><i>Default Value:</i> d</p>

➔ **Example** • Listed is an example of the ^HW command to retrieve from information R:

```
^XA
^HWR:*. *
^XZ
```

➔ **Example** • The printer returned this information as the Host Directory Listing: -DIR R:*. *

```
*R:ARIALN1.FNT 49140
*R:ARIALN2.FNT 49140
*R:ARIALN3.FNT 49140
*R:ARIALN4.FNT 49140
*R:ARIALN.FNT 49140
*R:ZEBRA.GRF 8420
-794292 bytes free R:RAM
```

^HY – Upload Graphics

Description The ^HY command is an extension of the ^HG command. ^HY is used to upload graphic objects from the printer in any supported format.

Format ^HYd:o.x

Parameters	Details
d = location of object	<i>Accepted Values:</i> R:, E:, B:, and A: <i>Default Value:</i> search priority
o = object name	<i>Accepted Values:</i> 1 to 8 alphanumeric characters <i>Default Value:</i> an object name must be specified
x = extension	<i>Accepted Values:</i> G = .GRF (raw bitmap format) P = .PNG (compressed bitmap format) <i>Default Value:</i> format of stored image

Comments The image is uploaded in the form of a ~DY command. The data field of the returned ~DY command is always encoded in the ZB64 format.

^HZ – Display Description Information

Description The ^HZ command is used for returning printer description information in XML format. The printer returns information on format parameters, object directories, individual object data, and print status information.

Format ^HZb

Parameters	Details
b = display description to return	<p><i>Accepted Values:</i></p> <ul style="list-style-type: none">a = display all informationf = display printer format setting informationl = display object directory listing informationo = display individual object data informationr = display printer status information <p><i>Default Value:</i> if the value is missing or invalid, the command is ignored</p>

Format ^HZO,d:o.x,1

Parameters	Details
d = location of stored object	<i>Accepted Values:</i> R:, E:, B:, and A: <i>Default Value:</i> R:
o = object name	<i>Accepted Values:</i> 1 to 8, or 1 to 16 alphanumeric characters based on parameter 1. <i>Default Value:</i> if a name is not specified, UNKNOWN is used.
x = extension	Supported extensions for objects (parameter o) include: <ul style="list-style-type: none"> .FNT — font .GRF — graphic .PNG — compressed graphic .ZPL — stored format .DAT — encoding table .ZOB — downloadable object .STO — Alert data file
1 = long filename support	<i>Accepted Values:</i> <ul style="list-style-type: none"> Y = Yes If Y, the object data stores the filename as 16 characters. The data is only compatible with firmware version V60.13.0.5, or later. N = No If N, the object data stores the filename as 8 characters. The data is forward and backward compatible with all versions of firmware. <i>Default Value:</i> N



Example • This example shows the object data information for the object `SAMPLE.GRF` located on R:

```
^XA
^HZO,R:SAMPLE.GRF
^XZ
```

^ID - Object Delete

Description The ^ID command deletes objects, graphics, fonts, and stored formats from storage areas. Objects can be deleted selectively or in groups. This command can be used within a printing format to delete objects before saving new ones, or in a stand-alone format to delete objects.

The image name and extension support the use of the asterisk (*) as a wild card. This allows you to easily delete a selected groups of objects.

Format ^IDd:o.x

Parameters	Details
d = location of stored object	<i>Accepted Values:</i> R:, E:, B:, and A: <i>Default Value:</i> R:
o = object name	<i>Accepted Values:</i> any 1 to 8 character name <i>Default Value:</i> if a name is not specified, UNKNOWN is used
x = extension	<i>Accepted Values:</i> any extension conforming to Zebra conventions <i>Default Value:</i> .GRF

➔ **Example 1** • To delete stored formats from DRAM:

```
^XA
^IDR:*.ZPL^FS
^XZ
```

➔ **Example 2** • To delete formats and images named SAMPLE from DRAM, regardless of the extension:

```
^XA
^IDR:SAMPLE.*^FS
^XZ
```

➔ **Example 3** • To delete the image SAMPLE1.GRF prior to storing SAMPLE2.GRF:

```
^XA
^F025,25^AD,18,10
^FDDelete^FS
^F025,45^AD,18,10
^FDthen Save^FS
^IDR:SAMPLE1.GRF^FS
^ISR:SAMPLE2.GRF^FS^XZ
```



Example 4 • In this the * is a wild card, indicating that all objects with the .GRF extension are deleted:

```
^XA  
^IDR:*.GRF^FS  
^XZ
```

Comments When an object is deleted from **R:**, the object can no longer be used and memory is available for storage. This applies only to **R:** memory. With the other memory types (**A:**, **B:**, **E:**) the deleted object is no longer available. The memory space recovers when an automatic defragmentation or initialization occurs.

The **^ID** command also frees up the uncompressed version of the object in DRAM.

If the name is specified as ***.ZOB**, all downloaded bar code fonts (or other objects) are deleted.

If the named downloadable object cannot be found in the **R:**, **E:**, **B:**, and **A:** device, the **^ID** command is ignored.

^IL - Image Load

Description The ^IL command is used at the beginning of a label format to load a stored image of a format and merge it with additional data. The image is always positioned at ^F00,0.



Important • See ^IS on page 248.

Using this technique to overlay the image of constant information with variable data greatly increases the throughput of the label format.

Format ^ILd:o.x

Parameters	Details
d = location of stored object	<i>Accepted Values:</i> R:, E:, B:, and A: <i>Default Value:</i> R:
o = object name	<i>Accepted Values:</i> 1 to 8 alphanumeric characters <i>Default Value:</i> if a name is not specified, UNKNOWN is used
x = extension	<i>Fixed Value:</i> .GRF, .PNG



Example • This example recalls the stored image **SAMPLE2.GRF** from DRAM and overlays it with the additional data. The graphic was stored using the ^IS command. For the stored label format, see the ^IS on page 248 command.

ZPL II CODE	GENERATED LABEL
<pre> ^XA ^ILR:SAMPLE2.GRF^FS ^CFD,36,20 ^FO15,210 ^FD900123^FS ^FO218,210 ^FDLINE 12^FS ^FO15,360^AD ^FDZEBRA THERMAL^FS ^FO15,400^AD ^FDTRANSFER PRINTER^FS ^FO15,540 ^FD54321^FS ^FO220,530 ^FDZ58643^FS ^FO15,670^A0,27,18 ^FDTesting Stored Graphic^FS ^FO15,700^A0,27,18 ^FDLabel Formats!!^FS ^XZ </pre>	

^IM – Image Move

Description The ^IM command performs a direct move of an image from storage area into the bitmap. The command is identical to the ^XG command (Recall Graphic), except there are no sizing parameters.

Format ^IMd:o.x

Parameters	Details
d = location of stored object	<i>Accepted Values:</i> R:, E:, B:, and A: <i>Default Value:</i> search priority
o = object name	<i>Accepted Values:</i> 1 to 8 alphanumeric characters <i>Default Value:</i> if a name is not specified, UNKNOWN is used
x = extension	<i>Fixed Value:</i> .GRF, .PNG



Example • This example moves the image SAMPLE.GRF from DRAM and prints it in several locations in its original size.

```
^XA
^F0100,100^IMR:SAMPLE.GRF^FS
^F0100,200^IMR:SAMPLE.GRF^FS
^F0100,300^IMR:SAMPLE.GRF^FS
^F0100,400^IMR:SAMPLE.GRF^FS
^F0100,500^IMR:SAMPLE.GRF^FS
^XZ
```

Comments By using the ^FO command, the graphic image can be positioned anywhere on the label.

The difference between ^IM and ^XG: ^IM does not have magnification, and therefore might require less formatting time. However, to take advantage of this, the image must be at a 8-, 16-, or 32-bit boundary.

^IS – Image Save

Description The ^IS command is used within a label format to save that format as a graphic image, rather than as a ZPL II script. It is typically used toward the end of a script. The saved image can later be recalled with virtually no formatting time and overlaid with variable data to form a complete label.

Using this technique to overlay the image of constant information with the variable data greatly increases the throughput of the label format.



Important • See [^IL](#) on page 246.

Format ^ISd:o.x,p

Parameters	Details
d = location of stored object	<i>Accepted Values:</i> R:, E:, B:, and A: <i>Default Value:</i> R:
o = object name	<i>Accepted Values:</i> 1 to 8 alphanumeric characters <i>Default Value:</i> if a name is not specified, UNKNOWN is used
x = extension	<i>Accepted Values:</i> .GRF or .PNG <i>Default Value:</i> .GRF
p = print image after storing	<i>Accepted Values:</i> N = no Y = yes <i>Default Value:</i> Y



Example • This is an example of using the ^IS command to save a label format to DRAM. The name used to store the graphic is **SAMPLE2.GRF**.

ZPL II CODE	GENERATED LABEL
<pre> ^XA ^LH10,15^FWN^BY3,3,85^CFD,36 ^GB430,750,4^FS ^FO10,170^GB200,144,2^FS ^FO10,318^GB410,174,2^FS ^FO212,170^GB206,144,2^FS ^FO10,498^GB200,120,2^FSR ^FO212,498^GB209,120,2^FS ^FO4,150^GB422,10,10^FS ^FO135,20^A0,70,60 ^FDZEBRA^FS ^FO80,100^A0,40,30 ^FDTECHNOLOGIES CORP^FS ^FO15,180^CFD,18,10^FS ^FDARTICLE#^FS ^FO218,180 ^FDLOCATION^FS ^FO15,328 ^FDDESCRIPTION^FS ^FO15,508 ^FDREQ.NO.^FS ^FO220,508 ^FDWORK NUMBER^FS ^FO15,630^AD,36,20 ^FDCOMMENTS:^FS ^ISR:SAMPLE2.GRF,Y ^XZ </pre>	<p>The generated label is a rectangular graphic with a white background and a black border. At the top, it features the Zebra logo: 'ZEBRA' in a large, bold, sans-serif font, with 'TECHNOLOGIES CORP' in a smaller, bold, sans-serif font directly below it. Below the logo, the label is divided into several sections:</p> <ul style="list-style-type: none"> A top section with two columns: 'ARTICLE#' on the left and 'LOCATION' on the right. A section labeled 'DESCRIPTION' spanning the width of the label. A section with two columns: 'REQ. NO.' on the left and 'WORK NUMBER' on the right. A bottom section labeled 'COMMENTS:' followed by a blank space for text.

~JA - Cancel All

Description The ~JA command cancels all format commands in the buffer. It also cancels any batches that are printing.

The printer stops after the current label is finished printing. All internal buffers are cleared of data and the DATA LED turn off.

Submitting this command to the printer scans the buffer and deletes only the data before the ~JA in the input buffer — it does not scan the remainder of the buffer for additional ~JA commands.

Format ~JA

^JB – Initialize Flash Memory

Description The ^JB command is used to initialize various types of Flash memory available in the Zebra printers.

Format ^JBa

Parameters	Details
a = device to initialize	<i>Acceptable Values:</i> A = Option Flash memory B = Flash card (PCMCIA) E = internal Flash memory <i>Default Value:</i> a device must be specified



Example • This is an example of initializing the different types of flash memory:

- ^JBA – initializes initial Compact Flash memory when installed in the printer.
- ^JBB – initializes the optional Flash card when installed in the printer.
- ^JBE – initializes the optional Flash memory when installed in the printer.



Note • Initializing memory can take several minutes. Be sure to allow sufficient time for the initialization to complete before power cycling the printer.

~JB - Reset Optional Memory

Description The ~JB command is used for these conditions:

- The ~JB command must be sent to the printer if the battery supplying power to the battery powered memory card fails and is replaced. A bad battery shows a *battery dead* condition on the Printer Configuration Label.
- The ~JB command can also be used to intentionally clear (reinitialize) the B: memory card. The card must **not** be write protected.

Format ~JB

Comments If the battery is replaced and this command is not sent to the printer, the memory card cannot function.

~JC - Set Media Sensor Calibration

Description The ~JC command is used to force a label length measurement and adjust the media and ribbon sensor values.

Format ~JC

Comments In Continuous Mode, only the media and ribbon sensors are calibrated.

This command is ignored on the HC100™ printer.

~JD - Enable Communications Diagnostics

Description The ~JD command initiates Diagnostic Mode, which produces an ASCII printout (using current label length and full width of printer) of all characters received by the printer. This printout includes the ASCII characters, the hexadecimal value, and any communication errors.

Format ~JD

~JE - Disable Diagnostics

Description The ~JE command cancels Diagnostic Mode and returns the printer to normal label printing.

Format ~JE

~JF – Set Battery Condition

Description There are two low battery voltage levels sensed by the *PA/PT400*TM printers. When battery voltage goes below the first level, the green LED begins flashing as a warning but printing continues. When this warning occurs, it is recommended to recharge the battery.

As printing continues, a second low voltage level is reached. At this point, both green and orange LEDs flash as a warning, and printing automatically pauses.

When pause on low voltage is active (**~JFY**) and the battery voltage level falls below the second *low voltage* level, printing pauses and an error condition is displayed as an indication that the printer should be plugged into the battery charger. By pressing **FEED**, printing continues on a label-by-label basis, but there is a high risk of losing label format information due to the continued decrease of battery voltage.

When pause on low voltage is not active (**~JFN**), and the battery voltage level falls below the second *low voltage* level, printing continues and the orange LED remains off. If the battery voltage continues to decrease, label information could be lost and cause the printer to stop operating. This option should be selected only when the printer is connected to the Car Battery Adapter. From time to time the printer might sense that battery voltage is below the first *low voltage* level, but due to the continuous recharging of the car battery, further loss of battery voltage is not a concern and printing continues.

If this option is not selected when using the Car Battery Adapter, you might need to press **FEED** to take the printer out of Pause Mode and print each label.

Format ~JFp

Parameters	Details
p = pause on low voltage	<p><i>Accepted Values:</i> Y (pause on low voltage) or N (do not pause)</p> <p>N is suggested when the printer is powered by the Car Battery Adapter.</p> <p><i>Default Value:</i> Y</p>

~JG - Graphing Sensor Calibration

Description The ~JG command prints a graph (media sensor profile) of the sensor values.

Format ~JG



Example • Sending the ~JG command to a printer configured for thermal transfer produces a series of labels resembling this image:

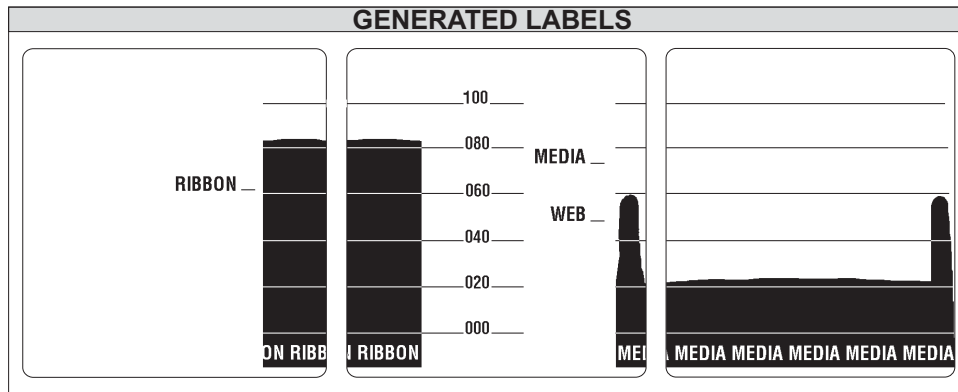

Comments The HC100™ printer does not perform a calibration, but does print a sensor profile label.

^JH – Early Warning Settings

Description The ^JH command configures the early warning messages that appear on the LCD.

Supported Devices

- ZE500 series
- XiIII, XiIIIPlus, Xi4, RXi4
- PAX3, PAX4
- ZM400, ZM600, RZ400, RZ600
- S4M
- G-Series (“f” parameter only)

Format ^JHa,b,c,d,e,f,g,h,i,j

Parameter	Details
a = early warning media	This parameter is for XiIIIPlus, Xi4, RXi4, PAX3, and PAX4 printers only.
a = supplies warning (Xi4 and RXi4 printers only)	<p><i>Accepted Values:</i></p> <p>E = enable D = disable</p> <p><i>Default Value: D</i></p>
b = labels per roll	<p>This parameter is for XiIIIPlus, PAX3, and PAX4 printers only.</p> <p><i>Accepted Values: 100 to 9999</i></p> <p><i>Default Value: 900</i></p>
c = media replaced	<p>This parameter is for XiIIIPlus, PAX3, and PAX4 printers only.</p> <p><i>Accepted Values:</i></p> <p>Y = yes N = no</p> <p><i>Default Value: N</i></p>

Parameter	Details																																				
d = ribbon length	<p>This parameter is for <i>XiIIIPlus</i>, <i>PAX3</i>, <i>PAX4</i>, and <i>ZE500</i> printers only.</p> <p><i>Accepted Values:</i></p> <p><i>XiIIIPlus</i> series printers:</p> <table> <tr> <td>N = 0M</td> <td></td> </tr> <tr> <td>0 = 100M</td> <td>4 = 300M</td> </tr> <tr> <td>1 = 150M</td> <td>5 = 350M</td> </tr> <tr> <td>2 = 200M</td> <td>6 = 400M</td> </tr> <tr> <td>3 = 250M</td> <td>7 = 450M</td> </tr> </table> <p>PAX series printers:</p> <table> <tr> <td>N = 0M</td> <td>7 = 450M</td> </tr> <tr> <td>0 = 100M</td> <td>10 = 600M</td> </tr> <tr> <td>1 = 150M</td> <td>11 = 650M</td> </tr> <tr> <td>2 = 200M</td> <td>12 = 700M</td> </tr> <tr> <td>3 = 250M</td> <td>13 = 750M</td> </tr> <tr> <td>4 = 300M</td> <td>14 = 800M</td> </tr> <tr> <td>5 = 350M</td> <td>15 = 850M</td> </tr> <tr> <td>6 = 400M</td> <td>16 = 900M</td> </tr> </table> <p>ZE500 series printers:</p> <table> <tr> <td>N = 0M</td> <td>4 = 300M</td> </tr> <tr> <td>0 = 100M</td> <td>5 = 350M</td> </tr> <tr> <td>1 = 150M</td> <td>6 = 400M</td> </tr> <tr> <td>2 = 200M</td> <td>7 = 450M</td> </tr> <tr> <td>3 = 250M</td> <td>10 = 600M</td> </tr> </table> <p><i>Default:</i></p> <p>1 - for 96<i>XiIIIPlus</i> 7 - for all other printers</p>	N = 0M		0 = 100M	4 = 300M	1 = 150M	5 = 350M	2 = 200M	6 = 400M	3 = 250M	7 = 450M	N = 0M	7 = 450M	0 = 100M	10 = 600M	1 = 150M	11 = 650M	2 = 200M	12 = 700M	3 = 250M	13 = 750M	4 = 300M	14 = 800M	5 = 350M	15 = 850M	6 = 400M	16 = 900M	N = 0M	4 = 300M	0 = 100M	5 = 350M	1 = 150M	6 = 400M	2 = 200M	7 = 450M	3 = 250M	10 = 600M
N = 0M																																					
0 = 100M	4 = 300M																																				
1 = 150M	5 = 350M																																				
2 = 200M	6 = 400M																																				
3 = 250M	7 = 450M																																				
N = 0M	7 = 450M																																				
0 = 100M	10 = 600M																																				
1 = 150M	11 = 650M																																				
2 = 200M	12 = 700M																																				
3 = 250M	13 = 750M																																				
4 = 300M	14 = 800M																																				
5 = 350M	15 = 850M																																				
6 = 400M	16 = 900M																																				
N = 0M	4 = 300M																																				
0 = 100M	5 = 350M																																				
1 = 150M	6 = 400M																																				
2 = 200M	7 = 450M																																				
3 = 250M	10 = 600M																																				
e = ribbon replaced	<p>This parameter is for <i>XiIIIPlus</i>, <i>PAX3</i>, and <i>PAX4</i> printers only.</p> <p><i>Accepted Values:</i></p> <p>Y = yes N = no</p> <p><i>Default Value:</i> N</p>																																				
f = early warning maintenance	<p>This parameter is for <i>Xi4</i>, <i>RXi4</i>, <i>PAX4</i>, <i>ZM400</i>, <i>ZM600</i>, <i>RZ400</i>, <i>RZ600</i>, and <i>S4M</i> printers only.</p> <p><i>Accepted Values:</i></p> <p>E = enabled D = disabled</p> <p><i>Default Value:</i> D</p> <p> Important • On G-Series printers, this parameter must be enabled for the ^MA driven system to work.</p>																																				

Parameter	Details																						
g = head cleaning interval	<p>Accepted value exceptions: accepted values for XiIII printer are 100M through 450M; accepted values for 600 dpi XiIII printers are 100M through 150M; accepted values for PAX4 series printers are up to 900M by increments of 50M; accepted values for ZM400/ZM600, RZ400/RZ600, and S4M printers are 0M through 450M.</p> <p><i>Accepted Values:</i></p> <table> <tr> <td>0 = 100M</td> <td>11 = 650M</td> </tr> <tr> <td>1 = 150M</td> <td>12 = 700M</td> </tr> <tr> <td>2 = 200M</td> <td>13 = 750M</td> </tr> <tr> <td>3 = 250M</td> <td>14 = 800M</td> </tr> <tr> <td>4 = 300M</td> <td>15 = 850M</td> </tr> <tr> <td>5 = 350M</td> <td>16 = 900M</td> </tr> <tr> <td>6 = 400M</td> <td></td> </tr> <tr> <td>7 = 450M</td> <td></td> </tr> <tr> <td>8 = 500M</td> <td></td> </tr> <tr> <td>9 = 550M</td> <td></td> </tr> <tr> <td>10 = 600M</td> <td></td> </tr> </table> <p><i>Default Value:</i> 1 - for 96XiIIIPlus 7 - for all other printers</p>	0 = 100M	11 = 650M	1 = 150M	12 = 700M	2 = 200M	13 = 750M	3 = 250M	14 = 800M	4 = 300M	15 = 850M	5 = 350M	16 = 900M	6 = 400M		7 = 450M		8 = 500M		9 = 550M		10 = 600M	
0 = 100M	11 = 650M																						
1 = 150M	12 = 700M																						
2 = 200M	13 = 750M																						
3 = 250M	14 = 800M																						
4 = 300M	15 = 850M																						
5 = 350M	16 = 900M																						
6 = 400M																							
7 = 450M																							
8 = 500M																							
9 = 550M																							
10 = 600M																							
h = head clean	<p><i>Accepted Values:</i> N = No Y = Yes</p> <p><i>Default Value: N</i></p>																						
i = head life threshold	<p><i>Accepted Values:</i> 0 – 0 in or off 100-3500000 in</p> <p><i>Default Value: 1000000</i></p>																						
j = head replaced	<p><i>Accepted Values:</i> N = no Y = yes</p> <p><i>Default Value: N</i></p>																						

Comments To permanently save the changes to the ^JH command, send ^XA^JUS^XZ.

^JI – Start ZBI (Zebra BASIC Interpreter)



Identifies features that are available in printers with firmware version V60.16.2Z, V53.16.2Z, or later.

Description ^JI works much like the ~JI command. Both commands are sent to the printer to initialize the Zebra BASIC Interpreter.

In interactive mode, ^JI can be sent through one of the communication ports (serial, parallel, or Ethernet) to initialize the printer to receive ZBI commands. This command can be sent from one of the Zebra software utilities, such as ZTools, or from a terminal emulation program.

When the command is received, the printer responds by sending a ZBI header back to the console, along with the program version number. This indicates that the interpreter is active.

Format ^JIid:o.x,b,c,d

Parameters	Details
d = location of program to run after initialization	<i>Acceptable Values:</i> R:, E:, B:, and A: <i>Default Value:</i> location must be specified
o = name of program to run after initialization	<i>Accepted Values:</i> any valid program name <i>Default Value:</i> name must be specified
x = extension of program to run after initialization	<i>Fixed Value:</i> .BAS, .BAE  .BAE is only supported in firmware version V60.16.0Z or later
b = console control	<i>Accepted Values:</i> Y = console on N = console off <i>Default Value:</i> Y
c = echoing control	<i>Accepted Values:</i> Y = echo on N = echo off <i>Default Value:</i> Y
d = memory allocation for ZBI *	<i>Accepted Values:</i> 20K to 1024K <i>Default Value:</i> 50K

* This parameter is only available on printers with firmware V60.12.0.x or earlier.

Comments When the printer is turned on, it can receive ZPL II commands and label formats. However, for the printer to recognize ZBI commands and programs, it must be initialized using ^JI or ~JI.

Only one ZBI interpreter can be active in the printer at a time. If a second ^JI or ~JI command is received while the interpreter is running, the command is ignored.

The interpreter is deactivated by entering one of two commands:

ZPL at the ZBI prompt

~JQ at an active ZPL port

~JI – Start ZBI (Zebra BASIC Interpreter)

.161

Identifies features that are available in printers with firmware version V60.16.2Z, V53.16.2Z, or later.

Description ~JI works much like the ^JI command. Both commands are sent to the printer to initialize the Zebra BASIC Interpreter.

In interactive mode, ~JI can be sent through one of the communication ports (serial, parallel, or Ethernet) to initialize the printer to receive ZBI commands. This command can be sent from one of the Zebra software utilities, such as ZTools, or from a standard PC program, such as Hyper terminal.

When the command is received, the printer responds by sending a ZBI header back to the console, along with the program version number. This indicates that the interpreter is active.

Format ~JI

Comments While receiving commands, the printer *echoes* the received characters back to the source. This can be toggled on and off with the ZBI ECHO command.

When the printer is turned on, it can receive ZPL II commands and label formats. However, for the printer to recognize ZBI commands and formats, it must be initialized using ^JI or ~JI.

Only one ZBI interpreter can be active in the printer at a time. If a second ~JI or ^JI command is received while the interpreter is running, the command is ignored.

The interpreter is deactivated by entering one of these commands:

- ZPL at the ZBI prompt

- ~JQ at an active ZPL port

^JJ – Set Auxiliary Port

Description The ^JJ command allows you to control an online verifier or applicator device.

Format ^JJa,b,c,d,e,f

Parameters	Details
a = operational mode for auxiliary port	<p><i>Accepted Values:</i></p> <ul style="list-style-type: none"> 0 = off 1 = reprint on error—the printer stops on a label with a verification error. When PAUSE is pressed, the label reprints (if ^JZ is set to reprint). If a bar code is near the upper edge of a label, the label feeds out far enough for the bar code to be verified and then backfeeds to allow the next label to be printed and verified. 2 = maximum throughput—the printer stops when a verification error is detected. The printer starts printing the next label while the verifier is still checking the previous label. This mode provides maximum throughput, but does not allow the printer to stop immediately on a label with a verification error. <p><i>Default Value:</i> 0</p>
b = application mode	<p><i>Accepted Values:</i></p> <ul style="list-style-type: none"> 0 = off 1 = End Print signal normally high, and low only when the printer is moving the label forward. 2 = End Print signal normally low, and high only when the printer is moving the label forward. 3 = End Print signal normally high, and low for 20 ms when a label has been printed and positioned. 4 = End Print signal normally low, and high for 20 ms when a label has been printed and positioned. <p><i>Default Value:</i> 0</p> <p> Note • The Set/Get/Do command <i>device.appliator.end_print</i> on page 682 controls the same setting as the b parameter.</p>
c = application mode start signal print	<p><i>Accepted Values:</i></p> <ul style="list-style-type: none"> p = Pulse Mode – Start Print signal must be de-asserted before it can be asserted for the next label. 1 = Level Mode – Start Print signal does not need to be de-asserted to print the next label. As long as the Start Print signal is low and a label is formatted, a label prints. <p><i>Default Value:</i> 0</p>

Parameters	Details
d = application label error mode	<p><i>Accepted Values:</i></p> <ul style="list-style-type: none">e = error mode—the printer asserts the <i>Service Required</i> signal (svce_req - pin 10) on the application port, enters into Pause Mode, and displays an error message on the LCD.f = Feed Mode—a blank label prints when the web is not found where expected to sync the printer to the media. <p><i>Default Value: f</i></p>
e = reprint mode	<p><i>Accepted Values:</i></p> <ul style="list-style-type: none">e = enabled—the last label reprints after the signal is asserted. If a label is canceled, the label to be reprinted is also canceled. This mode consumes more memory because the last printed label is not released until it reprints.d = disabled—printer ignores the Reprint signal. <p><i>Default Value: d</i></p>
f = ribbon low mode	<p><i>Accepted Values:</i></p> <ul style="list-style-type: none">e = <i>enabled</i> – printer warning issued when ribbon low.d = <i>disabled</i> – printer warning not issued when ribbon low. <p><i>Default Value: e</i></p>

~JL - Set Label Length

Description The ~JL command is used to set the label length. Depending on the size of the label, the printer feeds one or more blank labels.

Format ~JL

[^]JM – Set Dots per Millimeter

Description The [^]JM command lowers the density of the print—24 dots/mm becomes 12, 12 dots/mm becomes 6, 8 dots/mm becomes 4, and 6 dots/mm becomes 3. [^]JM also affects the field origin ([^]FO) placement on the label (see example below).

When sent to the printer, the [^]JM command doubles the format size of the label. Depending on the printhead, normal dot-per-millimeter capabilities for a Zebra printer are 12 dots/mm (304 dots/inch), 8 dots/mm (203 dots/inch) or 6 dots/mm (153 dots/inch).

This command must be entered before the first [^]FS command in a format. The effects of [^]JM are persistent.

Format [^]JMn

Parameters	Details
n = set dots per millimeter	<p><i>Accepted Values:</i></p> <p>A = 24 dots/mm, 12 dots/mm, 8 dots/mm or 6 dots/mm</p> <p>B = 12 dots/mm, 6 dots/mm, 4 dots/mm or 3 dots/mm</p> <p><i>Default Value:</i> A</p>

➔ **Example** • This example of the affects of alternating the dots per millimeter:

ZPL II CODE	GENERATED LABEL
<pre> [^]XA [^]JMA[^]FS [^]FO100,100 [^]B2N,50,Y,N,N [^]FD1234567890[^]FS [^]XZ </pre>	
<pre> [^]XA [^]JMB[^]FS [^]FO100,100 [^]B2N,50,Y,N,N [^]FD1234567890[^]FS [^]XZ </pre>	

Comments If [^]JMB is used, the UPS MaxiCode bar code becomes out of specification.

~JN - Head Test Fatal

Description The ~JN command turns on the head test option. When activated, ~JN causes the printer to halt when a head test failure is encountered.

Once an error is encountered the printer remains in error mode until the head test is turned off (~J0) or power is cycled.

Format ~JN

Comments If the communications buffer is full, the printer is not able to receive data. In this condition, the ~J0 command is not received by the printer.

~JO - Head Test Non-Fatal

Description The ~JO command configures the printer to run the head test with error reporting enabled. When ~JO is used an error will be displayed and printing will stop if the head test fails. The user can push the PAUSE button on the printer to bypass the error. This command differs from the ~JN (Head Test Fatal) command in that a power cycle is not required in the event of a head test failure.

~JO is the default print head test condition. This setting is changed when the printer receives a ~JN (Head Test Fatal) command.

Format ~JO

~JP - Pause and Cancel Format

Description The ~JP command clears the format currently being processed and places the printer into Pause Mode.

The command clears the next format that would print, or the oldest format from the buffer. Each subsequent ~JP command clears the next buffered format until the buffer is empty. The DATA indicator turns off when the buffer is empty and no data is being transmitted.

Issuing the ~JP command is identical to using CANCEL on the printer, but the printer does not have to be in Pause Mode first.

Format ~JP

~JQ – Terminate Zebra BASIC Interpreter



Identifies features that are available in printers with firmware version V60.16.2Z, V53.16.2Z, or later.

Description The ~JQ command is used when Zebra BASIC Interpreter is active. Sending ~JQ to the printer terminates the ZBI session.

Format ~JQ

Comments Entering ZPL at the command prompt also terminates a ZBI session.

~JR - Power On Reset

Description The ~JR command resets all of the printer's internal software, performs a power-on self-test (POST), clears the buffer and DRAM, and resets communication parameters and default values. Issuing a ~JR command performs the same function as a manual power-on reset.

Format ~JR

^JS - Sensor Select

Format ^JSa



Note • This command is ignored on Zebra ZM400/ZM600 and RZ400/RZ600 printers. This command is only for use with the S4M and Z Series printers (with the exception of the ZM400/ZM600/RZ400/RZ600).

Parameters	Details
a = sensor selection	<i>Accepted Values:</i> A = auto select R = reflective sensor T = transmissive sensor <i>Default Value:</i> Z series = A S4M = R

~JS – Change Backfeed Sequence

Description The ~JS command is used to control the backfeed sequence. This command can be used on printers with or without built-in cutters.

These are the primary applications:

- to allow programming of the *rest point* of the cut edge of continuous media.
- provide immediate backfeed after peel-off when the printer is used in a print/apply application configuration.

This command stays in effect only until the printer is turned off, a new ~JS command is sent, or the setting is changed on the control panel. When a ~JS command is encountered, it overrides the current control panel setting for the Backfeed Sequence.

The most common way of eliminating backfeed is to operate in Rewind Mode. Rewind Mode does not backfeed at all. After a label prints, the leading edge of the next label is placed at the print line. This eliminates the need to backfeed and does not introduce a non printable area at the leading edge or bottom of the label. It also does not allow the label to be taken from the printer because it is not fed out from under the printhead.

Running in another mode with backfeed turned off allows the label to be removed and eliminates the time-reduction of the backfeed sequence.

Format ~JSb

Parameters	Details
b = backfeed order in relation to printing	<p><i>Accepted Values:</i></p> <p>A = 100 percent backfeed after printing and cutting</p> <p>B = 0 percent backfeed after printing and cutting, and 100 percent before printing the next label</p> <p>N = normal — 90 percent backfeed after label is printed</p> <p>O = off — turn backfeed off completely</p> <p>10 to 90 = percentage value</p> <p>The value entered must be a multiple of 10. Values not divisible by 10 are rounded to the nearest acceptable value. For example, ~JS55 is accepted as 50 percent backfeed.</p> <p><i>Default Value:</i> N</p>

Comments When using a specific value, the difference between the value entered and 100 percent is calculated before the next label is printed. For example, a value of 40 means 40 percent of the backfeed takes place after the label is cut or removed. The remaining 60 percent takes place before the next label is printed.

The value for this command is also reflected in the Backfeed parameter on the printer configuration label.

For **~JSN** — the Backfeed parameter is listed as DEFAULT

For **~JSA** — or 100% the Backfeed parameter is listed as AFTER

For **~JSB** — or 0% the Backfeed parameter is listed as BEFORE

For **~JS10** — 10% of the backfeed takes place after the label is cut or removed. The remaining 90% takes place before the next label is printed.

This command is ignored on the HC100™ printer.

^JT – Head Test Interval

Description The ^JT command allows you to change the printhead test interval from every 100 labels to any desired interval. With the ^JT command, the printer is allowed to run the test after printing a label. When a parameter is defined, the printer runs the test after printing a set amount of labels.

The printer's default head test state is off. Parameters for running the printhead test are defined by the user.

Format ^JT####,a,b,c

Parameters	Details
#### = four-digit number of labels printed between head tests	<i>Accepted Values:</i> 0000 to 9999 If a value greater than 9999 is entered, it is ignored. <i>Default Value:</i> 0000 (off)
a = manually select range of elements to test	<i>Accepted Values:</i> N = no Y = yes <i>Initial Value at Power-up:</i> N
b = first element to check when parameter a is Y	<i>Accepted Values:</i> 0 to 9999 <i>Initial Value at Power-up:</i> 0
c = last element to check when parameter a is Y	<i>Accepted Values:</i> 0 to 9999 <i>Initial Value at Power-up:</i> 9999

Comments The ^JT command supports testing a range of print elements. The printer automatically selects the test range by tracking which elements have been used since the previous test.

^JT also turns on Automatic Mode to specify the first and last elements for the head test. This makes it possible to select any specific area of the label or the entire print width.

If the last element selected is greater than the print width selected, the test stops at the selected print width.

Whenever the head test command is received, a head test is performed on the next label unless the count is set to 0 (zero).

^JU – Configuration Update

Description The ^JU command sets the active configuration for the printer.

Format ^JUa

Parameters	Details
a = active configuration	<p><i>Accepted Values:</i></p> <ul style="list-style-type: none">F = reload factory settingsN = reload factory network settings <p>These values are lost at power-off if not saved with ^JUS.</p> <ul style="list-style-type: none">R = recall last saved settingsS = save current settings <p>These values are used at power-on.</p> <p><i>Default Value:</i> a value must be specified</p>

[^]JW – Set Ribbon Tension

Description [^]JW sets the ribbon tension for the printer it is sent to.

Format [^]JWt

Parameters	Details
t = tension	<p><i>Accepted Values:</i></p> <ul style="list-style-type: none"> L = low M = medium H = high <p><i>Default Value:</i> a value must be specified</p>

Comments [^]JW is used only for PAX series printers.

~JX - Cancel Current Partially Input Format

Description The ~JX command cancels a format currently being sent to the printer. It does not affect any formats currently being printed, or any subsequent formats that might be sent.

Format ~JX

^JZ – Reprint After Error

Description The ^JZ command reprints a partially printed label caused by a **Ribbon Out**, **Media Out**, or **Head Open** error condition. The label is reprinted as soon as the error condition is corrected.

This command remains active until another ^JZ command is sent to the printer or the printer is turned off.

Format ^JZa

Parameters	Details
a = reprint after error	<i>Accepted Values:</i> N = no Y = yes <i>Initial Value at Power-up: Y</i>

Comments ^JZ sets the error mode for the printer. If ^JZ changes, only labels printed after the change are affected.

If the parameter is missing or incorrect, the command is ignored.

~KB – Kill Battery (Battery Discharge Mode)

Description To maintain performance of the rechargeable battery in the portable printers, the battery must be fully discharged and recharged regularly. The ~KB command places the printer in battery discharge mode. This allows the battery to be drained without actually printing.

Format ~KB

Comments While the printer is in Discharge Mode, the green power LED flashes in groups of three flashes.

Discharge Mode might be terminated by sending a printing format to the printer or by pressing either of the control panel keys.

If the battery charger is plugged into the printer, the battery is automatically recharged once the discharge process is completed.

^KD – Select Date and Time Format (for Real Time Clock)

Description The ^KD command selects the format that the Real-Time Clock's date and time information presents as on a configuration label. This is also displayed on the *Printer Idle* LCD control panel display, and displayed while setting the date and time.

Format ^KD*a*

Parameters	Details
a = value of date and time format	<p><i>Accepted Values:</i></p> <ul style="list-style-type: none"> 0 = normal, displays <i>Version Number</i> of firmware 1 = MM/DD/YY (24-hour clock) 2 = MM/DD/YY (12-hour clock) 3 = DD/MM/YY (24-hour clock) 4 = DD/MM/YY (12-hour clock) <p><i>Default Value:</i> 0</p>

Comments If the Real-Time Clock hardware is not present, Display Mode is set to 0 (Version Number).

If Display Mode is set to 0 (Version Number) and the Real-Time Clock hardware is present, the date and time format on the configuration label is presented in format 1.

If Display Mode is set to 0 (Version Number) and the Real-Time Clock hardware is present, the date and time format on the control panel display is presented in format 1.

For more details on select date and time format for the Real Time Clock, see [Real Time Clock on page 1249](#).

^KL - Define Language

Description The ^KL command selects the language displayed on the control panel.

Format ^KL*a*

Parameters	Details
<i>a</i> = language	<p><i>Accepted Values:</i></p> <ul style="list-style-type: none">1 = English2 = Spanish3 = French4 = German5 = Italian6 = Norwegian7 = Portuguese8 = Swedish9 = Danish10 = Spanish211 = Dutch12 = Finnish13 = Japanese14 = Korean ^a15 = Simplified Chinese ^a16 = Traditional Chinese ^a17 = Russian ^a18 = Polish ^a19 = Czech ^a20 = Romanian ^a <p><i>Default Value: 1</i></p>

a. These values are only supported on the ZT200 Series, ZE500 Series, Xi4, RXi4, ZM400/ ZM600, and RZ400/RZ600 printers.

^KN – Define Printer Name

Description The printer’s network name and description can be set using the ^KN command. ^KN is designed to make your Zebra printer easy for users to identify. The name the administrator designates is listed on the configuration label and on the Web page generated by the printer.

Format ^KNa,b

Parameters	Details
a = printer name	<p><i>Accepted Values:</i> up to 16 alphanumeric characters</p> <p><i>Default Value:</i> if a value is not entered, the current stored value is erased</p> <p>If more than 16 characters are entered, only the first 16 are used.</p>
b = printer description	<p><i>Accepted Values:</i> up to 35 alphanumeric characters</p> <p><i>Default Value:</i> if a value is not entered, the current stored value is erased</p> <p>If more than 35 characters are entered, only the first 35 are used.</p> <p>Note • The value of this parameter will be displayed on the printer’s web page in parentheses.</p>



Example • This is an example of how to change the printer’s network name and description:

This shows how a configuration looks before using this command and after using this command:

```
^XA
^KNZebra1,desk_printer
^XZ
```

Before using this command:

PRINTER CONFIGURATION	
Zebra Technologies ZTC 105SL-200dpi	
+18.....	DARKNESS
-016.....	TEAR OFF
TEAR OFF.....	PRINT MODE
NON-CONTINUOUS.....	MEDIA TYPE
WEB.....	SENSOR TYPE
THERMAL-TRANS.....	PRINT METHOD
101 4/8 MM.....	PRINT WIDTH
1233.....	LABEL LENGTH
7.0IN 177MM.....	MAXIMUM LENGTH
PARALLEL.....	PARALLEL COMM.
RS232.....	SERIAL COMM.
9600.....	BAUD
8 BITS.....	DATA BITS
NONE.....	PARITY
XON/XOFF.....	HOST HANDSHAKE
NONE.....	PROTOCOL
000.....	NETWORK
NORMAL MODE.....	COMM.
<~> 7EH.....	
<^>	

After using this command:

PRINTER CONFIGURATION	
Zebra Technologies ZTC 105SL-200dpi Zebra1 desk_printer	
+18.....	DARKNESS
-016.....	TEAR OFF
TEAR OFF.....	PRINT MODE
NON-CONTINUOUS.....	MEDIA TYPE
WEB.....	SENSOR TYPE
THERMAL-TRANS.....	PRINT METHOD
101 4/8 MM.....	PRINT WIDTH
1233.....	LABEL LENGTH
7.0IN 177MM.....	MAXIMUM LENGTH
PARALLEL.....	PARALLEL COMM.
RS232.....	SERIAL COMM.
9600.....	BAUD
8 BITS.....	DATA BITS
NONE.....	PARITY
XON/XOFF.....	HOST HANDSHAKE
NONE.....	PROTOCOL
000.....	NETWORK
NORMAL MODE.....	COMM.
<~> 7EH.....	
<^>	

^KP – Define Password

Description The ^KP command is used to define the password that must be entered to access the control panel switches and LCD Setup Mode.

Format ^KP*a*,*b*

Parameters	Details
<i>a</i> = mandatory four-digit password	<i>Accepted Values:</i> any four-digit numeric sequence <i>Default Value:</i> 1234
<i>b</i> = password level	<i>Accepted Values:</i> 1, 2, 3, 4 <i>Default Value:</i> 3 Note • The <i>b</i> parameter applies only to the S4M printers.

→ **Example 1** • This example shows how to set a new control panel password:

```
^XA  
^KP5678  
^XZ
```

→ **Example 2** • This example shows how to set a new control panel password (5678) at a specific password level (level 2) (applicable to the S4M printer only):

```
^XA  
^KP5678,2  
^XZ
```

Comments If you forget your password, the printer can be returned to a default Setup Mode and the default password 1234 is valid again. Caution should be used, however — this also sets the printer configuration values back to their defaults.

To return the printer to the default factory settings using ZPL, send this:

```
^XA  
^JUF  
^XZ
```

To return the printer to the default factory settings using the control panel keys, see your printer's User Guide for the procedure.

^KV – Kiosk Values

Description The ^KV command sets several parameters that affect the printers operation when ^MM is set to K - Kiosk mode

Supported Devices

- KR403

Format ^KV`a,b,c,d,e`

Parameters	Details
a = kiosk cut amount	<p><i>Accepted Values:</i></p> <p>0 = normal cut 10-60 = partial cut, value = mm of media left uncut</p> <p><i>Default Value:</i> 0</p> <p>This parameter is ignored if it is missing or invalid. The current value of the parameter remains unchanged.</p>
b = kiosk cut margin	<p><i>Accepted Values:</i></p> <p>2 - 9 = mm of distance</p> <p><i>Default Value:</i></p> <p>9 = mm of distance</p> <p>This parameter is ignored if it is missing or invalid. The current value of the parameter remains unchanged.</p>
c = kiosk present type	<p><i>Accepted Values:</i></p> <p>0 = Eject page when new page is printed 1 = Retract page when new page is printed 2 = Do nothing when new page is printed</p> <p><i>Default Value:</i> 0</p> <p>This parameter is ignored if it is missing or invalid. The current value of the parameter remains unchanged.</p>
d = kiosk present timeout	<p><i>Accepted Values:</i></p> <p>0-300 = If label is not taken, retract label when timeout expires. Timeout is in seconds. Zero (0) indicates that there is no timeout. The label will stay presented until removed manually or a new label is printed.</p> <p><i>Default Value:</i> 0</p> <p>This parameter is ignored if it is missing or invalid. The current value of the parameter remains unchanged.</p>

Parameters	Details
e = presenter loop length	<p><i>Accepted Values:</i></p> <p>0 = paper is fed straight through the presenter 3-1023 = loop length in mm.</p> <p><i>Default Value: 400</i></p> <p>400= gives a loop of approximately 400mm</p> <p>This parameter is ignored if it is missing or invalid. The current value of the parameter remains unchanged. . If this is greater than loop_length_max (see SGD media.present.loop_length_max) then it will be set equal to loop_length_max.</p>

Kiosk Printing Examples

The following examples demonstrate the use of the ^KV, ^CN, ^PN and ^CP commands with 80mm wide continuous media and the printer set to Kiosk Mode (^MMK).



Example 1 • In this example, the ^KV command is set to the following:

- Cut - Full Cut
- Cut Margin - 9 mm
- Present Type - Eject page when the next page is printed
- Present Timeout - 6 seconds after printing, if the document is not taken, it will be retracted
- Presenter Loop Length - No loop

```

^XA
^MMK
^KV0,9,0,6,0
^F050,50^A0N,50,50^FDZebra Technologies^FS
^CN1
^PN0
^XZ

```



Note • The ^CN1 command (Cut Now) is included to ensure that a full cut is done. The ^PN0 (Present Now) command is included to ensure that the media is ejected when the user pulls on the leading edge of the media. In this example, if the user does not pull on the leading edge of the second document, it will be retracted.



Example 2 • This example contains only one change from the Example 1 - the Presenter Loop Length is now 100mm, and two documents will be printed instead of one.

```

^XA
^MMK
^KV0,9,2,6,100
^F050,50^A0N,50,50^FDZebra Technologies^FS
^CN1^PN0
^PQ2
^XZ

```



Example 3 • In this example, two documents will be printed, each one will be ejected from the printer.

```
^XA
^MMK
^KV0,9,2,6,100
^F050,50^A0N,50,50^FDZebra Technologies^FS
^CN1^CP0
^PQ2
^XZ
```



Example 4 • In this example, two documents, with partial cuts, will be printed, and a third document, with a full cut, will be printed.

```
^XA
^MMK
^KV50,9,0,0,0
^F050,50^A0N,50,50^FDPartial Cut^FS
^CN0^PN0
^PQ2
^XZ
^XA
^MMK
^KV0,9,2,6,0
^F050,50^A0N,50,50^FDFull Cut^FS
^CN1^CP0
^XZ
```



Example 5 • In this example, four documents will be printed – three with a partial cut and the fourth with a full cut. Additionally, the document length is set to 406 dots and the Media Tracking mode is set to "Continuous Media, Variable Length". The third document contains fields that are positioned outside of the 406 dot length – however, because the printer is set to "Continuous Media, Variable Length" Media Tracking mode, the printer will automatically adjust the document length to compensate.

```
^XA
^MMK
^LL406
^KV20,9,0,0,0
^F050,50^A0N,50,50^FDPartial Cut^FS
^CN0^PN0
^PQ2
^XZ

^XA
^MMK
^MNV
^KV20,9,0,0,0
^F050,50^A0N,50,50^FDPartial Cut^FS
^F050,150^A0N,50,50^FDPrinting Line 1^FS
^F050,250^A0N,50,50^FDPrinting Line 2^FS
^F050,350^A0N,50,50^FDPrinting Line 3^FS
^F050,450^A0N,50,50^FDPrinting Line 4^FS
^F050,550^A0N,50,50^FDPrinting Line 5^FS
^F050,650^A0N,50,50^FDPrinting Line 6^FS
^F050,750^A0N,50,50^FDPrinting Line 7^FS
^F050,850^A0N,50,50^FDPrinting Line 8^FS
^F050,950^A0N,50,50^FDPrinting Line 9^FS
^F050,1050^A0N,50,50^FDPrinting Line 10^FS
^F050,1150^A0N,50,50^FDPrinting Line 11^FS
^F050,1250^A0N,50,50^FDPrinting Line 12^FS
^F050,1350^A0N,50,50^FDPrinting Line 13^FS
^F050,1450^A0N,50,50^FDPrinting Line 14^FS
^F050,1550^A0N,50,50^FDPrinting Line 15^FS
^CN0^PN0
^XZ

^XA
^MMK
^KV0,9,0,0,0
^F050,50^A0N,50,50^FDFull Cut^FS
^CN0^PN1^CP0
^PQ1
^XZ
```

[^]LF - List Font Links



This command is available only for printers with firmware version V60.14.x, V50.14.x, or later.

Description The [^]LF command prints out a list of the linked fonts.



Example • This example shows that **SWISS721.TTF** is the based font. **ANMDJ.TTF** is the first linked font, and **MSGOTHIC.TTF** is the second linked extension:

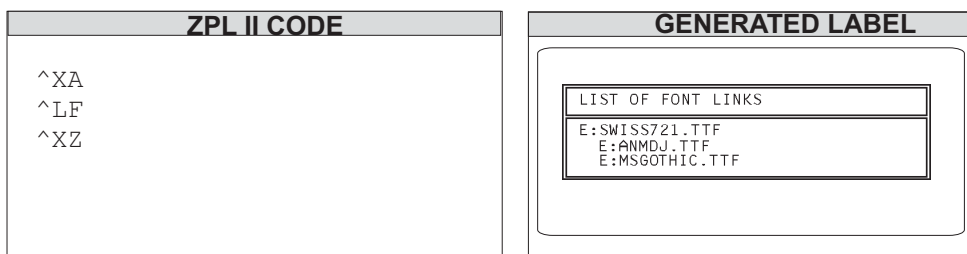

This is the code that established the font links:

```

^XA
^FLE:ANMDJ.TTF,E:SWISS721.TTF,1^FS
^FLE:MSGOTHIC.TTF,E:SWISS721.TTF,1^FS
^XZ
    
```

^LH – Label Home

Description The ^LH command sets the label home position.

The default home position of a label is the upper-left corner (position 0,0 along the x and y axis). This is the axis reference point for labels. Any area below and to the right of this point is available for printing. The ^LH command changes this reference point. For instance, when working with preprinted labels, use this command to move the reference point below the preprinted area.

This command affects only fields that come after it. It is recommended to use ^LH as one of the first commands in the label format.

Format ^LHx,y

Parameters	Details
x = x-axis position (in dots)	<i>Accepted Values:</i> 0 to 32000 <i>Initial Value at Power-up:</i> 0 or last permanently saved value
y = y-axis position (in dots)	<i>Accepted Values:</i> 0 to 32000 <i>Initial Value at Power-up:</i> 0 or last permanently saved value

Depending on the printhead used in your printer, use one of these when figuring the values for x and y:

- 6 dots = 1 mm, 152 dots = 1 inch
- 8 dots = 1 mm, 203 dots = 1 inch
- 11.8 dots = 1 mm, 300 dots = 1 inch
- 24 dots = 1 mm, 608 dots = 1 inch

Comments To be compatible with existing printers, this command must come before the first ^FS (Field Separator) command. Once you have issued an ^LH command, the setting is retained until you turn off the printer or send a new ^LH command to the printer.

^LL - Label Length

Description The ^LL command defines the length of the label. This command is necessary when using continuous media (media not divided into separate labels by gaps, spaces, notches, slots, or holes).

To affect the current label and be compatible with existing printers, ^LL must come before the first ^FS (Field Separator) command. Once you have issued ^LL, the setting is retained until you turn off the printer or send a new ^LL command.

Format ^LLy

Parameters	Details
y = y-axis position (in dots)	<p><i>Accepted Values:</i> 1 to 32000, not to exceed the maximum label size.</p> <p>While the printer accepts any value for this parameter, the amount of memory installed determines the maximum length of the label.</p> <p><i>Default Value:</i> typically set through the LCD (if applicable), or to the maximum label length capability of the printer.</p>

Comments These formulas can be used to determine the value of y:

For 6 dot/mm printheads...	Label length in inches x 152.4 (dots/inch) = y
For 8 dot/mm printheads...	Label length in inches x 203.2 (dots/inch) = y
For 12 dot/mm printheads...	Label length in inches x 304.8 (dots/inch) = y
For 24 dot/mm printheads...	Label length in inches x 609.6 (dots/inch) = y

Values for y depend on the memory size. If the entered value for y exceeds the acceptable limits, the bottom of the label is cut off. The label also shifts down from top to bottom.

If multiple ^LL commands are issued in the same label format, the last ^LL command affects the next label unless it is prior to the first ^FS.

This command is ignored on the HC100™ printer.

^LR - Label Reverse Print

Description The ^LR command reverses the printing of all fields in the label format. It allows a field to appear as white over black or black over white.

Using the ^LR is identical to placing an ^FR command in all current and subsequent fields.

Format ^LRa

Parameters	Details
a = reverse print all fields	<p><i>Accepted Values:</i></p> <p>N = no</p> <p>Y = yes</p> <p><i>Initial Value at Power-up:</i> N or last permanently saved value</p>



Example • This is an example that shows printing white over black and black over white. The ^GB command is used to create the black background.

ZPL II CODE	GENERATED LABEL
<pre> ^XA^LRY ^FO100,50 ^GB195,203,195^FS ^FO180,110^CFG ^FDLABEL^FS ^FO130,170 ^FDREVERSE^FS ^XZ </pre>	

Comments The ^LR setting remains active unless turned off by ^LRN or the printer is turned off.



Note • ^GB needs to be used together with ^LR.

Only fields following this command are affected.

^LS – Label Shift

Description The ^LS command allows for compatibility with Z-130 printer formats that are set for less than full label width. It is used to shift all field positions to the left so the same commands used on a Z-130 or Z-220 Printer can be used on other Zebra printers.

To determine the value for the ^LS command, use this formula:

$$\text{Z-130 and Z-220 values for } ^LHx + ^F0x \\ (\text{distance from edge of label}) = \text{printer value for } ^LSa$$

If the print position is less than 0, set ^LS to 0.

Format ^LSa



Important • The ability to save the ^LS command depends on the version of firmware.

Parameters	Details
a = shift left value (in dots)	<i>Accepted Values: -9999 to 9999</i> <i>Initial Value at Power-up: 0</i>

Comments When entering positive values, it is not necessary to use the + sign. The value is assumed to be positive unless preceded by a negative sign (-).

To be compatible with existing Zebra printers, this command must come before the first ^FS (Field Separator) command. Once you have issued an ^LS command, the setting is retained until you turn off the printer or send a new ^LS command to the printer.

^LT - Label Top

Description The ^LT command moves the entire label format a maximum of 120 dot rows up or down from its current position, in relation to the top edge of the label. A negative value moves the format towards the top of the label; a positive value moves the format away from the top of the label.

This command can be used to fine-tune the position of the finished label without having to change any of the existing parameters.



Important • For some printer models, it is possible to request a negative value large enough to cause the media to backup into the printer and become unthreaded from the platen. This condition can result in a printer error or unpredictable results.

Format ^LTx

Parameters	Details
x = label top (in dot rows)	<p><i>Accepted Values:</i></p> <p>HC100: 0 to 120</p> <p>XiIIIPlus 600dpi: -240 to 240</p> <p>All other Zebra printers: -120 to 120</p> <p><i>Default Value:</i> a value must be specified or the command is ignored</p>

Comments The Accepted Value range for x might be smaller depending on the printer platform.

The Label Top value shown on the front panel of the printer is double the value used in the ZPL format.

The ^LT command does not change the media rest position.

^MA – Set Maintenance Alerts



This command is available only for printers with firmware version V60.15.x, V50.15.x, or later.

Description The ^MA command controls how the printer issues printed maintenance alerts. Maintenance alerts are labels that print with a warning that indicates the printhead needs to be cleaned or changed.

Supported Devices

- Xi4, RXi4
- ZM400/ZM600, RZ400/RZ600
- S4M with v53.15.5Z or later
- G-Series



Important • ^MA settings do not impact or effect the functionality of the Xi4 Supplies Warning system.

Format ^MAtype,print,printlabel_threshold,frequency,units

Parameters	Details
type = type of alert	<p><i>Accepted Values:</i></p> <ul style="list-style-type: none"> R = head replacement C = head cleaning <p><i>Default Value:</i> This parameter must be specified as R or C for print, printlabel_threshold, and frequency to be saved. However, units will always be set.</p>
print = determines if the alert prints a label	<p><i>Accepted Values:</i></p> <ul style="list-style-type: none"> Y = print a label N = do not print label <p><i>Default Value:</i> N</p>
printlabel threshold= distance where the first alert occurs	<p><i>Accepted Values:</i></p> <ul style="list-style-type: none"> R = head replacement (unit of measurement for head is km with a range of 0 to 150 km) C = clean head (unit of measurement is 1 meter = 39.37 inches with a range of 0 to 2000 meters. The range for G-Series printers is 100 to 2000 meters. 0 = off (when set to 0, the selected alert is disabled; otherwise it is enabled). <p><i>Default Value:</i> R = 50 km (1,968,500 inches) and C = 0 (off).</p>
frequency = distance before reissuing the alert	<p>The unit of measurement is in meters. The range is 0 to 2000. The range for G-Series printers is 0 or 5 to 2000 meters. When set to 0, the alert label is only printed on power-up or when the printer is reset.</p> <p><i>Default Value:</i> 0 (print on power-up).</p>

Parameters	Details
<code>units</code> = odometer and printhead maintenance commands	<p>The <code>units</code> parameter reports units of the odometer and printhead maintenance commands, as follows: <code>~HQOD</code>, <code>~HQPH</code>, <code>~WQOD</code>, <code>~WQPH</code>.</p> <p><i>Accepted Values:</i></p> <ul style="list-style-type: none"><code>C</code> = centimeters (displays as: <code>cm</code>)<code>I</code> = inches (displays as: <code>"</code>)<code>M</code> = meters (displays as: <code>M</code>) <p><i>Default Value:</i> <code>I</code></p>



Example • This example sets the printed head cleaning message to print after five meters and to repeat every one meter after that until a `~ROC` command is issued.

The Early Warning Maintenance setting must be ON. To enable the maintenance alert system on the G-Series™ printer the `^JH` command is used; on other Zebra printers the front panel can also be used.

1. To set `^MA` to print out a label flagging the need to clean the head, type:

```
^XA^MAC,Y,5,1^XZ
```

When the threshold is met a label will print indicating that the head needs to be clean.

2. For this example, the message on the label looks like this:

PLEASE CLEAN PRINT HEAD

For details resetting the units of measure, see the `~HQ` examples on [page 227](#).

Comments Any values outside the specified range are ignored.

The intent of this command is to cause a label to print when the defined threshold is reached.

^MC – Map Clear

Description In normal operation, the bitmap is cleared after the format has been printed. The ^MC command is used to retain the current bitmap. This applies to current and subsequent labels until cleared with ^MCY.

Format ^MCa



Important • To produce a label template, ^MC must be used with ^FV.

Parameters	Details
a = map clear	<i>Accepted Values:</i> Y (clear bitmap) or N (do not clear bitmap) <i>Initial Value at Power-up:</i> Y

Comments The ^MC command retains the image of the current label after formatting. It appears in the background of the next label printed.

^MD – Media Darkness

Description The ^MD command adjusts the darkness relative to the current darkness setting.

Format ^MDa

Parameters	Details
a = media darkness level	<p><i>Accepted Values:</i> -30 to 30, depending on current value</p> <p><i>Initial Value at Power-up:</i> 0</p> <p>If no value is entered, this command is ignored.</p>



Example 1 • These examples show setting the printer to different darkness levels:

- If the current value (value on configuration label) is 16, entering the command ^MD-9 decreases the value to 7.
- If the current value (value on configuration label) is 1, entering the command ^MD15 increases the value to 16.
- If the current value (value on configuration label) is 25, entering the command ^MD10 increases only the value to 30, which is the maximum value allowed.

Each ^MD command is treated separately in relation to the current value as printed on the configuration label.



Note • On Zebra G-Series™ printers the value set with the ^MD command is persistent across power cycles.



Important • The darkness setting range for the XiIIIPlus, Xi4, and RXi4 is 0 to 30 in increments of 0.1.

The firmware is setup so that the ^MD and ~SD commands (ZPL darkness commands) accepts that range of settings.



Example 2 • These are examples of the XiIIIPlus, Xi4, and RXi4 Darkness Setting:

^MD8.3

~SD8.3



Example 3 • For example, this is what would happen if two ^MD commands were received:

Assume the current value is 15. An ^MD-6 command is received that changes the current value to 9. Another command, ^MD2, is received. The current value changes to 17.

The two ^MD commands are treated individually in relation to the current value of 15.

Comments The ~SD command value, if applicable, is added to the ^MD command.

^MF – Media Feed

Description The ^MF command dictates what happens to the media at power-up and at head-close after the error clears.

Format ^MFp,h

Parameters	Details
p = feed action at power-up	<p><i>Accepted Values:</i></p> <ul style="list-style-type: none"> F = feed to the first web after sensor C = (see ~JC on page 253 definition) L = (see ~JL on page 266 definition) N = no media feed S = short calibration ^a <p><i>Default Value: C</i></p>
h = feed action after closing printhead	<p><i>Accepted Values:</i></p> <ul style="list-style-type: none"> F = feed to the first web after sensor C = (see ~JC on page 253 definition) L = (see ~JL on page 266 definition) N = no media feed S = short calibration ^a <p><i>Default Value: C</i></p>

a. These values are supported only on Xi4, RXi4, *XiIIIPlus*, PAX, ZM400/ZM600, RZ400/RZ600, and S4M printers.

Comments It is important to remember that if you choose the N setting, the printer assumes that the media and its position relative to the printhead are the same as before power was turned off or the printhead was opened. Use the ^JU command to save changes.

^MI – Set Maintenance Information Message

.15†

This command is available only for printers with firmware version V60.15.x, V50.15.x, or later.

Description The ^MI command controls the content of maintenance alert messages, which are reminders printed by the printer to instruct the operator to clean or replace the printhead.

Supported Devices

- Xi4, RXi4
- ZM400/ZM600m RZ400/RZ600
- S4M with v53.15.5Z or later
- G-Series

Format ^MItype,message

Parameters	Details
type = identifies the type of alert	<p><i>Accepted Values:</i></p> <ul style="list-style-type: none"> R = head replacement C = head cleaning <p><i>Default Value:</i> R</p>
message = message that prints on the label when a maintenance alert occurs	<p>The maximum length of each message is 63 characters. All characters following the comma and preceding the next tilde (~) or carat (^) define the message string. Commas (,) are not allowed in the message.</p> <p><i>Default Value:</i></p> <ul style="list-style-type: none"> HEAD CLEANING = please clean printhead HEAD REPLACEMENT = please replace printhead



Example • This example sets the printhead (head) replacement warning message. Printing of this message is controlled by the ^MA command.

1. To customize the text of this label, type something like this:
^XA^MIR,PRINT HEAD NEEDS REPLACEMENT - CALL EXT 1000^XZ
The label prints whatever you program it to say.
2. For this example, the message on the label looks like this:

PRINT HEAD NEEDS REPLACEMENT - CALL EXT 1000

^ML – Maximum Label Length

Description The ^ML command lets you adjust the maximum label length.

Format ^MLa

Parameters	Details
a = maximum label length (in dot rows)	<i>Accepted Values:</i> 0 to maximum length of label <i>Default Value:</i> last permanently saved value

Comments For calibration to work properly, you must set the maximum label length equal to or greater than your actual label length.

This command is ignored on the HC100™ printer.

^MM – Print Mode

Description The ^MM command determines the action the printer takes after a label or group of labels has printed.



Note • Refer to the User Guide for your printer to determine which print modes are supported by your printer.

Format ^MMa,b

Parameters	Details
a = desired mode	<p><i>Accepted Values:</i></p> <ul style="list-style-type: none"> T = Tear-off ^a P = Peel-off (not available on S-300) ^a R = Rewind (depends on printer model) A = Applicator (depends on printer model) ^a C = Cutter (depends on printer model) D = Delayed cutter ^a F = RFID ^a L = Reserved ^{a, b} U = Reserved ^{a, b} K = Kiosk ^c <p><i>Default Value:</i></p> <p>The values available for parameter a depend on the printer being used and whether it supports the option.</p> <p>For RFID printers:</p> <ul style="list-style-type: none"> A = R110PAX4 print engines F = other RFID printers
b = prepeel select	<p><i>Accepted Values:</i></p> <ul style="list-style-type: none"> N = no Y = yes <p><i>Default Value: N</i></p> <p>The command is ignored if parameters are missing or invalid. The current value of the command remains unchanged.</p>

a. This value is not supported on the KR403 or ZD500R printer.

b. This value is supported only on the ZM400 and ZM600 printers.

c. This value is supported only the KR403 printer.

This list identifies the different modes of operation:

- Tear-off — after printing, the label advances so the web is over the tear bar. The label, with liner attached, can be torn off manually.
- Peel-off — after printing, the label moves forward and activates a Label Available Sensor. Printing stops until the label is manually removed from the printer.

Power Peel – liner automatically rewinds using an optional internal rewind spindle.

Value Peel – liner feeds down the front of the printer and is manually removed.

Prepeel – after each label is manually removed, the printer feeds the next label forward to prepeel a small portion of the label away from the liner material. The printer then backfeeds and prints the label. The prepeel feature assists in the proper peel operation of some media types.

- Rewind — the label and liner are rewound on an (optional) external rewind device. The next label is positioned under the printhead (no backfeed motion).
- Applicator — when used with an application device, the label move far enough forward to be removed by the applicator and applied to an item. This applies only to printers that have applicator ports and that are being used in a print-and-apply system.
- Cutter — after printing, the media feeds forward and is automatically cut into predetermined lengths.
- Delayed cutter — When the printer is in the Delayed Cut PRINT MODE, it will cut the label when it receives the ~JK (Delayed Cut) command. To activate the ~JK command, the printer's PRINT MODE must be set to Delayed Cut and there must be a label waiting to be cut. When the printer is not in the Delayed Cut PRINT MODE, the printer will not cut the label when it receives the ~JK command.



Note • Send ~JK in a separate file - it cannot be sent at the end of a set of commands.

The Delayed Cut feature can be activated:

- through PRINT MODE on the printer's control panel
- with a ^MMD command
- RFID — increases throughput time when printing batches of RFID labels by eliminating backfeed between labels.
- Kiosk — after printing, the media is moved in a presentation position, most applications maintain a loop of media in the printer.

Comments Be sure to select the appropriate value for the print mode being used to avoid unexpected results.

This command is ignored on the HC100™ printer.

^MN – Media Tracking

Description This command specifies the media type being used and the black mark offset in dots.

This bulleted list shows the types of media associated with this command:

- Continuous Media – this media has no physical characteristic (such as a web, notch, perforation, black mark) to separate labels. Label length is determined by the ^LL command.
- Continuous Media, variable length – same as Continuous Media, but if portions of the printed label fall outside of the defined label length, the label size will automatically be extended to contain them. This label length extension applies only to the current label. Note that ^MNV still requires the use of the ^LL command to define the initial desired label length.
- Non-continuous Media – this media has some type of physical characteristic (such as web, notch, perforation, black mark) to separate the labels.

Format ^MNa,b

Parameters	Details
a = media being used	<p><i>Accepted Values:</i></p> <ul style="list-style-type: none"> N = continuous media Y = non-continuous media web sensing ^{d, e} W = non-continuous media web sensing ^{d, e} M = non-continuous media mark sensing A = auto-detects the type of media during calibration ^{d, f} V = continuous media, variable length ^g <p><i>Default Value:</i> a value must be entered or the command is ignored</p>
b = black mark offset in dots	<p>This sets the expected location of the media mark relative to the point of separation between documents. If set to 0, the media mark is expected to be found at the point of separation. (i.e., the perforation, cut point, etc.)</p> <p>All values are listed in dots. This parameter is ignored unless the a parameter is set to M. If this parameter is missing, the default value is used.</p> <p><i>Accepted Values:</i></p> <ul style="list-style-type: none"> -80 to 283 for direct-thermal only printers -240 to 566 for 600 dpi printers -75 to 283 for KR403 printers -120 to 283 for all other printers <p><i>Default Value:</i> 0</p>

- d. Provides the same result.
- e. This value is not supported on the KR403 printer.
- f. This parameter is supported only on G-series printers.
- g. This parameter is supported only on the KR403 printer.

Comments This command is ignored on the HC100™ printer.

^MP – Mode Protection

Description The ^MP command is used to disable the various mode functions on the control panel. Once disabled, the settings for the particular mode function can no longer be changed and the LED associated with the function does not light.

Because this command has only one parameter, each mode must be disabled with an individual ^MP command.

Format ^MPa

Parameters	Details
a = mode to protect	<p><i>Accepted Values:</i></p> <ul style="list-style-type: none"> D = disable Darkness Mode P = disable Position Mode C = disable Calibration Mode E = enable all modes S = disable all mode saves (modes can be adjusted but values are not saved) W = disable Pause F = disable Feed X = disable Cancel M = disable menu changes <p><i>Default Value:</i> a value must be entered or the command is ignored</p>



Example • This example shows the ZPL code that disables modes D and C. It also shows the effects on the configuration label before and after the ZPL code is sent:

^XA
^MPD
^MPC
^XZ

Before

DPCSFXM..... MODES ENABLED
..... MODES DISABLED

After

.P.SWFXM..... MODES ENABLED
D.C..... MODES DISABLED

PRINTER CONFIGURATION	
Zebra Technologies	
ZTC 110X1111P1us-300dpi	
ZBR14629777	
10.2.....	DARKNESS
2 IPS.....	PRINT SPEED
+000.....	TEAR OFF
TEAR OFF.....	PRINT MODE
NON-CONTINUOUS.....	MEDIA TYPE
WEB.....	SENSOR TYPE
THERMAL-TRANS.....	PRINT METHOD
105 08/12 MM.....	PRINT WIDTH
1828.....	LABEL LENGTH
39.0IN 988PM.....	MAXIMUM LENGTH
MEDIA DISABLED.....	EARLY WARNING
PRINT OFF.....	EARLY WARNING
NOT CONNECTED.....	USB COMM.
BIDIRECTIONAL.....	PARALLEL COMM.
RS232.....	SERIAL COMM.
9600.....	BAUD
8 BITS.....	DATA BITS
NONE.....	PARITY
XON/XOFF.....	HOST HANDSHAKE
NONE.....	PROTOCOL
000.....	NETWORK ID
NORMAL MODE.....	COMMUNICATIONS
<> ZSH.....	CONTROL PREFIX
<> SEH.....	FORMAT PREFIX
<> ZSH.....	DELIMITER CHAR
ZPL II.....	ZPL MODE
NO MOTION.....	MEDIA POWER UP
NO MOTION.....	HEAD CLOSE
DEFAULT.....	BACKFEED
+000.....	LABEL TOP
+0000.....	LEFT POSITION
0000.....	HEAD TEST COUNT
1447.....	HEAD RESISTOR
OFF.....	VERIFIER PORT
OFF.....	APPLICATION PORT
ENABLED.....	ERROR ON PAUSE
PULSE MODE.....	START PRINT SIG
FEED MODE.....	RESYNCH MODE
DISABLED.....	REPRINT MODE
050.....	WEB S.
078.....	MEDIA S.
072.....	RIBBON S.
015.....	TAKE LABEL
055.....	MARK S.
000.....	MARK MED S.
073.....	MEDIA LED
033.....	RIBBON LED
028.....	MARK LED
+10.....	LED ADJUST
DPCSFXM.....	MODES ENABLED
.....	MODES DISABLED
1248 12/MM FULL.....	RESOLUTION
V60.15.12P07 <.....	FIRMWARE
V30 7888 S.....	HARDWARE ID
CUSTOMIZED.....	CONFIGURATION
NONE.....	COMPACT FLASH
11776k.....	RAM
2048k.....	ONBOARD FLASH
NONE.....	FORMAT CONVERT
005 DISPLAY.....	P32 INTERFACE
001 POWER SUPPLY.....	P35 INTERFACE
FW VERSION.....	TWINAX/COAX ID
11/16/06.....	IDLE DISPLAY
16:10.....	RTC DATE
NONE.....	RTC TIME
NONE.....	ZEBRA NET II
NO.....	RTD READY
15940 IN.....	NONRESET CNTR
15940 IN.....	RESET CNTR1
15940 IN.....	RESET CNTR2
39850 CH.....	NONRESET CNTR
39850 CH.....	RESET CNTR1
39850 CH.....	RESET CNTR2
4207 LABELS.....	NONRESET CNTR
4207 LABELS.....	RESET CNTR1
4207 LABELS.....	RESET CNTR2
OK 38850.0 S NYS07015.41008.07 VHL.....	
2006-06-14 16:30:23	TIME STAMP

FIRMWARE IN THIS PRINTER IS COPYRIGHTED

^MT – Media Type

Description The ^MT command selects the type of media being used in the printer.

These are the choices for this command:

- Thermal Transfer Media – this media uses a high-carbon black or colored ribbon. The ink on the ribbon is bonded to the media.
- Direct Thermal Media – this media is heat sensitive and requires no ribbon.

Format ^MTa

Parameters	Details
a = media type used	<i>Accepted Values:</i> T = thermal transfer media D = direct thermal media <i>Default Value:</i> a value must be entered or the command is ignored

Comments This command is ignored on the HC100™ printer.

^MU – Set Units of Measurement

Description The ^MU command sets the units of measurement the printer uses. ^MU works on a field-by-field basis. Once the mode of units is set, it carries over from field to field until a new mode of units is entered.

^MU also allows for printing at lower resolutions — 600 dpi printers are capable of printing at 300, 200, and 150 dpi; 300 dpi printers are capable of printing at 150 dpi.

Format ^MUa,b,c

Parameters	Details
a = units	<p><i>Accepted Values:</i></p> <p>D = dots I = inches M = millimeters</p> <p><i>Default Value:</i> D</p>
b = format base in dots per inch	<p><i>Accepted Values:</i> 150, 200, 300</p> <p><i>Default Value:</i> a value must be entered or the command is ignored</p>
c = desired dots-per-inch conversion	<p><i>Accepted Values:</i> 300, 600</p> <p><i>Default Value:</i> a value must be entered or the command is ignored</p>



Example 1 • This is an example of Setting Units:

Assume 8 dot/millimeter (203 dot/inch) printer.

Field based on dots:

```
^MUD^FO100,100^GB1024,128,128^FS
```

Field based on millimeters:

```
^MUM^FO12.5,12.5^GB128,16,16^FS
```

Field based on inches:

```
^MUI^FO.493,.493^GB5.044,.631,.631^FS
```



Example 2 • This is an example of Converting dpi Values.

Convert a 150 dpi format to a 300 dpi format with a base in dots:

```
^MUD,150,300
```

Convert a 150 dpi format to a 600 dpi format with a base in dots:

```
^MUD,150,600
```

Convert a 200 dpi format to a 600 dpi format with a base in dots:

```
^MUD,200,600
```

To reset the conversion factor to the original format, enter matching values for parameters b and c:

```
^MUD,150,150
```

```
^MUD,200,200
```

```
^MUD,300,300
```

```
^MUD,600,600
```

Comments This command should appear at the beginning of the label format to be in proper ZPL II format.

To turn the conversion off, enter matching values for parameter **b** and **c**.

^MW – Modify Head Cold Warning

Description The ^MW command allows you to set the head cold warning indicator based on the operating environment.

Format ^MWa

Parameters	Details
a = enable head cold warning	<i>Accepted Values:</i> Y = enable head cold warning N = disable head cold warning



Important • When a parameter is **not** given, the instruction is *ignored*.

^NC – Select the Primary Network Device

Description The ^NC command selects the wired or wireless print server as the primary network device.

Supported Devices

- Xi4, RXi4
- ZM400/ZM600, RZ400/RZ600

The Xi4, RXi4, ZM400/ZM600, and RZ400/RZ600 printers support the simultaneous installation of an internal, external, and a wireless print server. Even though all three print servers may be installed, only one is connected to the network and is the active print server. [Table 15](#) outlines priorities and identifies which device becomes the active print server when multiple print servers are installed.

Table 15 • Effect of Primary Network Setting on Active Print Server

If the Primary Network is set to:	Installed and Connected to a Live Ethernet Network			Then, the Active Print Server will be:
	Internal	External	Wireless ^a	
Wired	X	X	X	Internal
		X	X	External
			X	Wireless
Wireless	X	X	X	Wireless
	X	X		Internal
		X		External

a. A wireless option board must have an active radio that can properly associate to an access point.

Format ^NCa

Parameters	Details
a = primary network device	<p><i>Accepted Values:</i></p> <p>1 = wired primary</p> <p>2 = wireless primary</p> <p><i>Default Value: 1</i></p> <p>must be an accepted value or it is ignored</p>

~NC – Network Connect

Description The ~NC command is used to connect a particular printer to a network by calling up the printer's network ID number.

Format ~NC###

Parameters	Details
### = network ID number assigned (must be a three-digit entry)	<i>Accepted Values:</i> 001 to 999 <i>Default Value:</i> 000 (none)

Comments Use this command at the beginning of any label format to specify which printer on the network is going to be used. Once the printer is established, it continues to be used until it is changed by another ~NC command. This command must be included in the label format to *wake up the printer*.

The commands ^MW, ~NC, ^NI, ~NR, and ~NT are used only with RS-422/485 printer communications.

^ND – Change Network Settings

Description The ^ND command changes the network settings on supported printers.

For the external wired print server settings, the ^ND command is the same as the ^NS command. For the wireless print server settings, the ^ND command is the same as the ^WI command.

Supported Devices

- Xi4 with firmware V53.17.1Z or later
- RXi4
- RZ400/RZ600 with firmware R53.15.xZ or later
- ZM400/ZM600 with firmware V53.15.xZ or later
- G-Series

Format ^NDa,b,c,d,e,f,g,h,i,j

Parameters	Details
a = the device that is being modified	<p><i>Accepted Values:</i></p> <p>1 = external wired 2 = internal wired 3 = wireless</p>
b = IP resolution	<p><i>Accepted Values:</i></p> <p>A = All B = BOOTP C = DHCP and BOOTP D = DHCP G = Gleaning only (Not recommended when the Wireless Print Server or Wireless Plus Print Server is installed.) R = RARP P = Permanent</p> <p><i>Default Value: A</i></p>
c = IP address	<p><i>Accepted Values:</i> Any properly formatted IP address in the xxx.xxx.xxx.xxx format.</p>
d = subnet mask	<p><i>Accepted Values:</i> Any properly formatted subnet mask in the xxx.xxx.xxx.xxx format.</p>
e = default gateway	<p><i>Accepted Values:</i> Any properly formatted gateway in the xxx.xxx.xxx.xxx format.</p>
f = WINS server address	<p><i>Accepted Values:</i> Any properly formatted WINS server in the xxx.xxx.xxx.xxx format.</p>
g = connection timeout checking	<p><i>Accepted Values:</i></p> <p>Y = yes N = no</p> <p><i>Default Value: Y</i></p>

Parameters	Details
h = timeout value	Time, in seconds, before the connection times out. <i>Accepted Values:</i> 0 through 9999 <i>Default Value:</i> 300
i = ARP broadcast interval	Time, in minutes, that the broadcast is sent to update the device's ARP cache. <i>Accepted Values:</i> 0 through 30 <i>Default Value:</i> 0 (no ARP sent)
j = base raw port number	The port number that the printer should use for its RAW data. <i>Accepted Values:</i> 1 through 65535 <i>Default Value:</i> 9100

^NI – Network ID Number

Description The ^NI command is used to assign a network ID number to the printer. This must be done before the printer can be used in a network.

Format ^NI###

Parameters	Details
### = network ID number assigned (must be a three-digit entry)	<i>Accepted Values: 001 to 999</i> <i>Default Value: 000 (none)</i>

Comments The last network ID number set is the one recognized by the system.

The commands ~NC, ^NI, ~NR, and ~NT are used only with RS-485 printer communications.

~NR – Set All Network Printers Transparent

Description The ~NR command sets all printers in the network to be transparent, regardless of ID or current mode.

Format ~NR

Comments The commands ~NC, ^NI, ~NR, and ~NT are used only with RS-485 printer communications.

^NS – Change Wired Networking Settings

Description Use this command to change the wired print server network settings.

Format ^NSa,b,c,d,e,f,g,h,i

Parameters	Details
a = IP resolution	<p><i>Accepted Values:</i></p> <ul style="list-style-type: none"> A = ALL B = BOOTP C = DHCP AND BOOTP D = DHCP G = GLEANING ONLY R = RARP P = PERMANENT <p><i>Default Value:</i> A_</p> <p>Use of GLEANING ONLY is not recommended when the Wireless Print Server or Wireless Plus Print Server is installed.</p>
b = IP address	<p><i>Accepted Values:</i> Any properly formatted IP address in the xxx.xxx.xxx.xxx format.</p>
c = subnet mask	<p><i>Accepted Values:</i> Any properly formatted subnet mask in the xxx.xxx.xxx.xxx format.</p>
d = default gateway	<p><i>Accepted Values:</i> Any properly formatted gateway in the xxx.xxx.xxx.xxx format.</p>
e = WINS server address	<p><i>Accepted Values:</i> Any properly formatted WINS server in the xxx.xxx.xxx.xxx format.</p>
f = connection timeout checking	<p><i>Accepted Values:</i></p> <ul style="list-style-type: none"> Y = Yes N = No <p><i>Default Value:</i> Y</p>
g = timeout value	<p>Time, in seconds, before the connection times out.</p> <p><i>Accepted Values:</i> 0 through 9999</p> <p><i>Default Value:</i> 300</p>
h = ARP broadcast interval	<p>Time, in minutes, that the broadcast is sent to update the device's ARP cache.</p> <p><i>Accepted Values:</i> 0 through 30</p> <p><i>Default Value:</i> 0 (no ARP sent)</p>
i = base raw port number	<p>The port number that the printer should use for its RAW data.</p> <p><i>Accepted Values:</i> 1 through 65535</p> <p><i>Default Value:</i> 9100</p>

Comments For the Xi4, RXI4, ZM400/ZM600, and RZ400/RZ600 printers, Zebra recommends that you use the ^ND command instead of the ^NS command.



Example •

```
^XA  
^NSa,192.168.0.1,255.255.255.0,192.168.0.2  
^XZ
```

~NT – Set Currently Connected Printer Transparent

Description The ~NT command sets the currently connected network printer to be transparent.

Format ~NT

Comments With Z Series® printers, the ~NT command functions the same as the ~NR command. All Z Series printers on a network receive the transmission.

The commands ~NC, ^NI, ~NR, and ~NT are used only with RS-485 printer communications.

^PA – Advanced Text Properties



This command is available only for printers with firmware version V60.14.x, V50.14.x, or later.

Description The ^PA command is used to configure advanced text layout features.

Format ^PAa,b,c,d

Parameters	Details
a = default glyph	This determines whether the default glyph is a space character or the default glyph of the base font, which is typically a hollow box. <i>Accepted Values:</i> 0 = off (space as default glyph) 1 = on (default glyph of font is used, often a hollow box, but depends on the font.) <i>Default Value:</i> 0
b = bidirectional text layout	This determines whether the bidirectional text layout is turned on or off. <i>Accepted Values:</i> 0 = off 1 = on <i>Default Value:</i> 0
c = character shaping	This determines whether character shaping is turned on or off. <i>Accepted Values:</i> 0 = off 1 = on <i>Default Value:</i> 0
d = OpenType table support	This determines whether the OpenType support is turned on or off. <i>Accepted Values:</i> 0 = off 1 = on <i>Default Value:</i> 0

^PF – Slew Given Number of Dot Rows

Description The ^PF command causes the printer to slew labels (move labels at a high speed without printing) a specified number of dot rows from the bottom of the label. This allows faster printing when the bottom portion of a label is blank.

Format ^PF#

Parameters	Details
# = number of dots rows to slew	<i>Accepted Values:</i> 0 to 32000 <i>Default Value:</i> a value must be entered or the command is ignored

^PH ~PH – Slew to Home Position

Description The ^PH or ~PH command causes the printer to feed one blank label.

The ~PH command feeds one label after the format currently being printed is done or when the printer is placed in pause.

The ^PH command feeds one blank label after the current format prints.

Format ^PH or ~PH

~PL – Present Length Addition

Description The ~PL command adds an additional amount to how far the paper is ejected during a present cycle. A standard amount of 50mm is always added to clear the kiosk wall. This amount is added to that 50mm. The total amount of media ejected when a ^PN is executed, then, is 50mm + ~PL value + ^PN value.

Supported Devices

- KR403

Format ^PLa

Parameters	Details
a = additional eject length	<i>Accepted Values:</i> 000-255 = additional mm of media to eject <i>Default Value:</i> 000 The command is ignored if parameters are missing or invalid.

^PM – Printing Mirror Image of Label

Description The ^PM command prints the entire printable area of the label as a mirror image. This command flips the image from left to right.

Format ^PMa

Parameters	Details
a = print mirror image of entire label	<i>Accepted Values:</i> N = no Y = yes <i>Default Value:</i> N



Example • This is an example of printing a mirror image on a label:

ZPL II CODE	GENERATED LABEL
<pre>^XA^PMY ^FO100,100 ^CFG ^FDMIRROR^FS ^FO100,160 ^FDIMAGE^FS ^XZ</pre>	

Comments If the parameter is missing or invalid, the command is ignored. Once entered, the ^PM command remains active until ^PMN is received or the printer is turned off.

^PN – Present Now

Description The ^PN command causes the printer to run a Presenter cycle. The parameter defines the amount of media ejected. The total amount of media ejected when a ^PN is executed, then, is 50mm + ~PL value + ^PN value. (See [~PL on page 324](#)).

Supported Devices

- KR403

Format ^PNa

Parameters	Details
a = media eject length	<i>Accepted Values:</i> 0-255 = additional mm of media to eject <i>Default Value:</i> none The command is ignored if parameters are missing or invalid.

^PO – Print Orientation

Description The ^PO command inverts the label format 180 degrees. The label appears to be printed upside down. If the original label contains commands such as ^LL, ^LS, ^LT and ^PF, the inverted label output is affected differently.

Format ^POa

Parameters	Details
a = invert label 180 degrees	<p><i>Accepted Values:</i></p> <p>N = normal</p> <p>I = invert</p> <p><i>Default Value: N</i></p>



Example • This is an example of printing a label at 180 degrees:

ZPL II CODE	GENERATED LABEL
<pre> ^XA^CFD ^POI ^LH330,10 ^FO50,50 ^FDZEBRA TECHNOLOGIES^FS ^FO50,75 ^FDVernon Hills, IL^FS ^XZ </pre>	

The ^POI command inverts the x, y coordinates. All image placement is relative to these inverted coordinates. Therefore, a different ^LH (Label Home) can be used to move the print back onto the label.

Comments If multiple ^PO commands are issued in the same label format, only the last command sent to the printer is used.

Once the ^PO command is sent, the setting is retained until another ^PO command is received or the printer is turned off.

The N value for the a parameter is not supported on the HC100™ printer.

^PP ~PP – Programmable Pause

Description The ~PP command stops printing after the current label is complete (if one is printing) and places the printer in Pause Mode.

The ^PP command is not immediate. Therefore, several labels might print before a pause is performed. This command pauses the printer after the current format prints.

The operation is identical to pressing PAUSE on the control panel of the printer. The printer remains paused until PAUSE is pressed or a ~PS (Print Start) command is sent to the printer.

Format ^PP or ~PP

^PQ – Print Quantity

Description The ^PQ command gives control over several printing operations. It controls the number of labels to print, the number of labels printed before printer pauses, and the number of replications of each serial number.

Format ^PQq,p,r,o,e

Parameters	Details
q = total quantity of labels to print	<i>Accepted Value:</i> 1 to 99,999,999 <i>Default Value:</i> 1
p = pause and cut value (labels between pauses)	<i>Accepted Value:</i> 1 to 99,999,999 <i>Default Value:</i> 0 (no pause)
r = replicates of each serial number	<i>Accepted Value:</i> 0 to 99,999,999 replicates <i>Default Value:</i> 0 (no replicates)
o = override pause count	<i>Accepted Values:</i> N = no Y = yes <i>Default Value:</i> N
e = cut on error label (RFID void is an error label)	<i>Accepted Values:</i> N = no - if a cutter is installed, a cut will be made after a voided RIFD label ONLY if a cut would be made after the non-voided label and this was the last retry. Y = yes - if a cutter is installed, a cut will be made after ANY voided RFID label. <i>Default Value:</i> Y

If the o parameter is set to Y, the printer cuts but does not pause, and the printer does **not** pause after every group count of labels has been printed. With the o parameter set to N (default), the printer pauses after every group count of labels has been printed.



Example • This example shows the control over print operations:

^PQ50,10,1,Y: This example prints a total of 50 labels with one replicate of each serial number. It prints the total quantity in groups of 10, but does not pause after every group.

^PQ50,10,1,N: This example prints a total of 50 labels with one replicate of each serial number. It prints the total quantity in groups of 10, pausing after every group.

~PR – Applicator Reprint

Description If the ~PR command is enabled (see [^JJ on page 264](#)), the last label printed reprints, similar to the applicator asserting the Reprint signal on the applicator port. This command is similar to [device.applicator.reprint on page 686](#).

Supported Devices

- ZE500
- *XiIIIPlus*
- Xi4 with firmware V53.17.1Z or later
- *PAX2, PAX4*
- S4M
- ZM400/ZM600

Format ~PR

Comments Pressing PREVIOUS on the control panel also causes the last label to reprint.

^PR – Print Rate

Description The ^PR command determines the media and slew speed (feeding a blank label) during printing.

The printer operates with the selected speeds until the setting is reissued or the printer is turned off.

The print speed is application-specific. Because print quality is affected by media, ribbon, printing speeds, and printer operating modes, it is very important to run tests for your applications.



Important • Some models go to default print speed when power is turned off.

Format ^PRp,s,b

Parameters	Details
p = print speed	<p><i>Accepted Values:</i></p> <p>1 = 25.4 mm/sec. (1 inch/sec.)^a</p> <p>A or 2 = 50.8 mm/sec. (2 inches/sec.)</p> <p>B or 3 = 76.2 mm/sec. (3 inches/sec.)</p> <p>C or 4 = 101.6 mm/sec. (4 inches/sec.)</p> <p>5 = 127 mm/sec.(5 inches/sec.)</p> <p>D or 6 = 152.4 mm/sec. (6 inches/sec.)</p> <p>7 = 177.8 mm/sec. (7 inches/sec.)</p> <p>E or 8 = 203.2 mm/sec. (8 inches/sec.)</p> <p>9 = 220.5 mm/sec. 9 inches/sec.)</p> <p>10 = 245 mm/sec.(10 inches/sec.)</p> <p>11 = 269.5 mm/sec.(11 inches/sec.)</p> <p>12 = 304.8 mm/sec. 12 inches/sec.)</p> <p>13 = 13 in/sec^b</p> <p>14 = 14 in/sec^b</p> <p><i>Default Value: A</i></p>

a. This value is supported only on the 110Xi4-600dpi, 110XiIIIPlus-600dpi, and RXi printers.

b. This value is supported only on the Xi4 and RXi4 printers.

Parameters	Details
s = slew speed	<p><i>Accepted Values:</i></p> <p>A or 2 = 50.8 mm/sec. (2 inches/sec.) B or 3 = 76.2 mm/sec. (3 inches/sec.) C or 4 = 101.6 mm/sec. (4 inches/sec.) 5 = 127 mm/sec. 5 inches/sec.) D or 6 = 152.4 mm/sec. (6 inches/sec.) 7 = 177.8 mm/sec. (7 inches/sec.) E or 8 = 203.2 mm/sec. (8 inches/sec.) 9 = 220.5 mm/sec. (9 inches/sec.) 10 = 245 mm/sec. (10 inches/sec.) 11 = 269.5 mm/sec. 11 inches/sec.) 12 = 304.8 mm/sec. 12 inches/sec.) 13 = 13 in/sec^b 14 = 14 in/sec^b</p> <p><i>Default Value: D</i></p>
b = backfeed speed	<p><i>Accepted Values:</i></p> <p>A or 2 = 50.8 mm/sec. (2 inches/sec.) B or 3 = 76.2 mm/sec. (3 inches/sec.) C or 4 = 101.6 mm/sec. (4 inches/sec.) 5 = 127 mm/sec.(5 inches/sec.) D or 6 = 152.4 mm/sec. (6 inches/sec.) 7 = 177.8 mm/sec. (7 inches/sec.) E or 8 = 203.2 mm/sec. (8 inches/sec.) 9 = 220.5 mm/sec. 9 inches/sec.) 10 = 245 mm/sec. 10 inches/sec.) 11 = 269.5 mm/sec. 11 inches/sec.) 12 = 304.8 mm/sec. 12 inches/sec.) 13 = 13 in/sec^b 14 = 14 in/sec^b</p> <p><i>Default Value: A</i></p>

- a. This value is supported only on the 110Xi4-600dpi, 110XiIIIPlus-600dpi , and RXi printers.
- b. This value is supported only on the Xi4 and RXi4 printers.

Comments The speed setting for **p**, **s**, and **b** is dependent on the limitations of the printer. If a particular printer is limited to a rate of 6 ips (inches per second), a value of 12 can be entered but the printer performs only at a 6 ips rate. See your printer’s User Guide for specifics on performance.

This command is ignored on the HC100 printer.

~PS - Print Start

Description The ~PS command causes a printer in Pause Mode to resume printing. The operation is identical to pressing PAUSE on the control panel of the printer when the printer is already in Pause Mode.

Format ~PS

^PW – Print Width

Description The ^PW command allows you to set the print width.

Format ^PWa

Parameters	Details
a = label width (in dots)	<i>Accepted Values:</i> 2, to the width of the label If the value exceeds the width of the label, the width is set to the label's maximum size. <i>Default Value:</i> last permanently saved value

Comments This command is ignored on the HC100™ printer.

~RO – Reset Advanced Counters

Description The ~RO command resets the advanced counters used by the printer to monitor label generation in inches, centimeters, and number of labels.

Format ~ROc

Parameters	Details
c = counter number	<p><i>Accepted Values:</i></p> <ul style="list-style-type: none"> 1 = reset counter 1 2 = reset counter 2 3 = reset valid RFID label counter 4 = reset voided RFID label counter C = reset head cleaned counter^h R = reset head replaced counter and head cleaned counter^h <p><i>Default Value:</i> a value must be specified or the command is ignored</p>

h. These values are supported only on Xi4, RXi4, ZM400/ZM600, RZ400/RZ600, S4M, and G-Series printers.



Example 1 • This example shows how the counter portion of the printer configuration labels looks when counter 1 is reset by sending ~RO1.

Before

```

296862 IN..... NONRESET CNTR
296862 IN..... RESET CNTR1
296862 IN..... RESET CNTR2
753289 CM..... NONRESET CNTR
753289 CM..... RESET CNTR1
753289 CM..... RESET CNTR2
92928 LABLS..... NONRESET CNTR
92928 LABLS..... RESET CNTR1
92928 LABLS..... RESET CNTR2

```

After

```

296876 IN..... NONRESET CNTR
0 IN..... RESET CNTR1
296876 IN..... RESET CNTR2
753323 CM..... NONRESET CNTR
0 CM..... RESET CNTR1
753323 CM..... RESET CNTR2
92930 LABLS..... NONRESET CNTR
0 LABLS..... RESET CNTR1
92930 LABLS..... RESET CNTR2

```

^SC – Set Serial Communications

Description The ^SC command allows you to change the serial communications parameters you are using.

Format ^SCa,b,c,d,e,f

Parameters	Details
a = baud rate	<i>Accepted Values:</i> 110 ^a ; 300; 600; 1200; 2400; 4800; 9600; 14400; 19200; 28800; 38400; or 57600; 115200 <i>Default Value:</i> must be specified or the parameter is ignored
b = word length (in data bits)	<i>Accepted Values:</i> 7 or 8 <i>Default Value:</i> must be specified
c = parity	<i>Accepted Values:</i> N (none), E (even), or O (odd) <i>Default Value:</i> must be specified
d = stop bits	<i>Accepted Values:</i> 1 or 2 <i>Default Value:</i> must be specified
e = protocol mode	<i>Accepted Values:</i> X = XON/XOFF D = DTR/DSR R = RTS M = DTR/DSR XON/XOFF ^b <i>Default Value:</i> must be specified
f = Zebra protocol	<i>Accepted Values:</i> A = ACK/NAK N = none Z = Zebra <i>Default Value:</i> must be specified

a. This value is not supported on Xi4, RXi4, ZM400/ZM600, RZ400/RZ600, and S4M printers.

b. This parameter is supported only on G-Series printers. Using the DTR/DSR XON/XOFF mode will cause the printer to respond to either DTR/DSR or XON/XOFF, depending on which method is first received from the host device.

Comments If any of the parameters are missing, out of specification, not supported by a particular printer, or have a ZPL-override DIP switch set, the command is ignored.

A ^JUS command causes the changes in Communications Mode to persist through power-up and software resets.

~SD – Set Darkness

Description The ~SD command allows you to set the darkness of printing. ~SD is the equivalent of the darkness setting parameter on the control panel display.

Format ~SD##

Parameters	Details
## = desired darkness setting (two-digit number)	<i>Accepted Values:</i> 00 to 30 <i>Default Value:</i> last permanently saved value



Important • The darkness setting range for the *XiIIIPlus*, Xi4, and RXi4 is 0 to 30 in increments of 0.1. The firmware is setup so that the ^MD and ~SD commands (ZPL darkness commands) accept that range of settings.



Example • These are examples of the *XiIIIPlus*, Xi4, and RXi4 Darkness Setting:

^MD8.3

~SD8.3

Comments The ^MD command value, if applicable, is added to the ~SD command.

^SE – Select Encoding Table

Description The ^SE command is used to select the desired ZPL or ZPL II encoding table.

Format ^SEd:o.x

Parameters	Details
d = location of encoding table	<i>Accepted Values:</i> R:, E:, B:, and A: <i>Default Value:</i> R:
o = name of encoding table	<i>Accepted Value:</i> 1 to 8 alphanumeric characters <i>Default Value:</i> a value must be specified
x = extension	<i>Fixed Value:</i> .DAT

The encoding tables are provided with the font card or downloaded in flash with the font. The table appears as **XXXXXXX.DAT** in a directory label printed by the ZPL commands.

The most active encoding table is indicated by the * on the directory label.



Example •

```
^XA^WD*:*.*^XZ
```

^SF – Serialization Field (with a Standard ^FD String)

Description The ^SF command allows you to serialize a standard ^FD string. The maximum size of the mask and increment string is 3K combined.



In firmware version x.14 and later, strings are serialized from the last character in the backing store with regard to the alignment of the mask and increment strings. For combining semantic clusters that do not get incremented, the mask character % needs to be added to the increment string.

Format ^SFa,b

Parameters	Details
a = mask string	<p>The mask string sets the serialization scheme. The length of the string mask defines the number of characters (or in firmware version x.14 and later, combining semantic clusters) in the current ^FD string to be serialized. The mask is aligned to the characters (or in firmware version x.14 and later, combining semantic clusters) in the ^FD string starting with the right-most (or in firmware x.14 and later, last) in the backing store position.</p> <p><i>Mask String placeholders:</i></p> <ul style="list-style-type: none"> D or d – Decimal numeric 0–9 H or h – Hexadecimal 0–9 plus a-f or A-F O or o – Octal 0–7 A or a – Alphabetic A–Z or a–z N or n – Alphanumeric 0–9 plus A–Z or a–z % – Ignore character or skip
b = increment string	<p>The increment string is the value to be added to the field on each label. The default value is equivalent to a decimal value of one. The string is composed of any characters (or in firmware version x.14 and later, combining semantic clusters) defined in the serial string. Invalid characters (or in firmware version x.14 and later, combining semantic clusters) are assumed to be equal to a value of zero in that characters (or in firmware version x.14 and later, combining semantic clusters) position.</p> <p>The increment value for alphabetic strings start with ‘A’ or ‘a’ as the zero placeholder. This means to increment an alphabetic character (or in firmware version x.14 and later, combining semantic cluster) by one, a value of ‘B’ or ‘b’ must be in the increment string.</p>

For characters that do not get incremented, the % character needs to be added to the increment string.



Example 1 • This is an example of serializing a ^FD string. The ZPL II code generates three separate labels as seen in Generated Labels:

ZPL II CODE	GENERATED LABELS
<pre> ^XA ^FO100,100 ^CF0,100 ^FD12A^SFnnA,F^FS ^PQ3 ^XZ </pre>	<div style="border: 1px solid black; padding: 5px; text-align: center; font-size: 24pt; font-weight: bold;">12K</div> <div style="border: 1px solid black; padding: 5px; text-align: center; font-size: 24pt; font-weight: bold;">12F</div> <div style="border: 1px solid black; padding: 5px; text-align: center; font-size: 24pt; font-weight: bold;">12A</div>

This mask has the first characters (or in firmware version x.14 and later, the first combining semantic clusters) as alphanumeric (nn = 12) and the last digit as uppercase alphabetic (A). The decimal value of the increment number is equivalent to 5 (F). The number of labels generated depends on the number specified by the ^PQ command.

In a similar instance, the ^FD string could be replaced with either of the ^FD strings below to generate a series of label, determined by ^PQ.

Using this ZPL code:

```
^FDBL0000^SFAAdddd,1
```

The print sequence on this series of labels is:

```
BL0000, BL0001, ...BL0009, BL0010, ...
BL0099, BL0100, ...BL9999, BM0000...
```

Using this ZPL code:

```
^FDBL00-0^SFAAdd%d,1%1
```

The print sequence on this series of labels is:

```
BL00-0, BL01-1, BL02-2, ...BL09-9,
BL11-0, BL12-1...
```



Important notes about masking for firmware version V60.14.x, V50.14.x, or later:

- A single % masks an entire combining semantic cluster rather than a single code point.
- The mask string and increment string should be aligned at the last code point in their respective backing stores.
- Control and bidirectional characters do not require a mask and are ignored for serialization purposes.

The following examples show the importance of capitalization and location within the mask.



Example 2 • In this example, the printer cycles with every two printed labels and alternates between H (position 18), and then Z (position 36). With n or N, the serial number increments from 0 - 9 and a-z or A-Z (36 positions overall). With each completed cycle, the second cluster (nn) increments one position (from 00, 01, 02 ...) per cycle:

ZPL II CODE	GENERATED LABELS
<pre> ^XA ^FO100,50^A0N,50,50^FDzzZ^SFnnN,I^FS ^PQ10 ^XZ </pre>	



Example 3 • In this example, lower case i increments with a mask string of nnN. Nothing changes because the first cluster (Z) never triggers the second cluster (zz) to change.

ZPL II CODE	GENERATED LABELS
<pre> ^XA ^FO100,50^A0N,50,50^FDzzZ^SFnnN,i^FS ^PQ10 ^XZ </pre>	

^SI – Set Sensor Intensity



This command is available only for printers with firmware versions V53.15.x or later.

Description The ^SI command is used to change the values for the media sensors, which are also set during the media calibration process. The media calibration process is described in your specific printer's user's guide.

Supported Devices

- Xi4 with firmware V53.17.1Z or later
- RXi4 with firmware V53.17.7Z or later
- ZM400/ZM600 with firmware V53.15.xZ or later
- RZ400/RZ600 with firmware R53.15.xZ or later

Format ^SIa,b

Parameters	Details
a = indicates the setting to modify	<p><i>Accepted Values:</i></p> <ul style="list-style-type: none"> 1 = transmissive sensor brightness setting 2 = transmissive sensor baseline setting <p><i>Default Value:</i> must be an accepted value or the entire command is ignored</p>
b = the value to use for the sensor being configured	<p>The ranges for this parameter are the same for the accepted values in parameter a.</p> <p><i>Accepted Values:</i> 0 to 196</p> <p><i>Default Value:</i> must be an accepted value or the entire command is ignored</p>

^SL – Set Mode and Language (for Real-Time Clock)

Description The ^SL command is used to specify the Real-Time Clock's mode of operation and language for printing information.



Important •

- Time is read when the image is created. If the image stays in the queue longer than the specified time the image will be recreated with a new time.
- There are incidents when the same time or a larger space of time may be printed on labels. This is due to the format complexity and print speed.

Format ^SLa,b

Parameters	Details
a = mode	<p><i>Accepted Values:</i></p> <p>S = Start Time Mode. This is the time that is read from the Real-Time Clock when label formatting begins (when ^XA is received). The first label has the same time placed on it as the last label.</p> <p>T = Time Now Mode. This is the time that is read from the Real-Time Clock when the label to be printed is placed in print queue. <i>Time Now</i> is similar to a serialized time or date field.</p> <p>Numeric Value = With the Enhanced Real Time Clock (V60.13.0.10 or later) a time accuracy tolerance can be specified. Range = 1 to 999 seconds, 0 = one second tolerance</p> <p>Example: SL30,1 = Accuracy tolerance of 30 seconds and use English.</p> <p><i>Default Value: S</i></p>

a. These values are only supported on the Xi4, RXi4, ZM400/ZM600, and RZ400/RZ600 printers.

Parameters	Details
<p>b = language</p> <p> Value 13 is only supported in firmware versions V60.14.x, V50.14.x, or later.</p>	<p><i>Accepted Values:</i></p> <ul style="list-style-type: none"> 1 = English 2 = Spanish 3 = French 4 = German 5 = Italian 6 = Norwegian 7 = Portuguese 8 = Swedish 9 = Danish 10 = Spanish 2 11 = Dutch 12 = Finnish 13 = Japanese 14 = Korean ^a 15 = Simplified Chinese ^a 16 = Traditional Chinese ^a 17 = Russian ^a 18 = Polish ^a <p><i>Default Value:</i> the language selected with ^KL or the control panel</p>

a. These values are only supported on the Xi4, RXi4, ZM400/ZM600, and RZ400/RZ600 printers.

Comments These are some comments to be aware of:

- The ^SL command must be placed before the first ^FO command.
- As of V60.13.0.10 all supported printers have Enhanced Real Time Clock capabilities the RTC will not print time fields that are more than sixty seconds old, rather it will update the time prior to printing (^SLT or ^SL60). To control time with increments other than sixty seconds the ^SL command can be used with a numeric value (^SL30).
^SLS can keep times longer than sixty seconds.

For more details on set mode and language with the Real-Time Clock, see [Real Time Clock on page 1249](#).

^SN – Serialization Data

Description The ^SN command allows the printer to index data fields by a selected increment or decrement value, making the data fields increase or decrease by a specified value each time a label is printed. This can be performed on 100 to 150 fields in a given format and can be performed on both alphanumeric and bar code fields. A maximum of 12 of the right-most integers are subject to indexing.

.13↓

In x.13 and earlier, the first integer found when scanning from right to left starts the indexing portion of the data field.

.14↑

In x.14 and later, the first integer found when scanning from end of the backing store towards the beginning starts the indexing portion of the data field.

.13↓

In x.13 and earlier, if the alphanumeric field to be indexed ends with an alpha character, the data is scanned, character by character, from right to left until a numeric character is encountered. Serialization takes place using the value of the first number found.

.14↑

In x.14 and later, if the backing store of the alphanumeric field to be indexed ends with an alpha character, the data is scanned, character by character, from the end of the backing store until a numeric character is encountered. Serialization takes place using the value of the first number found.

Format ^SNv,n,z

Parameters	Details
v = starting value	<i>Accepted Values:</i> 12-digits maximum for the portion to be indexed <i>Default Value:</i> 1
n = increment or decrement value	<i>Accepted Values:</i> 12-digit maximum <i>Default Value:</i> 1 To indicate a decrement value, precede the value with a minus (–) sign.
z = add leading zeros (if needed)	<i>Accepted Values:</i> N = no Y = yes <i>Default Value:</i> N



Example • This example shows incrementing by a specified value:

ZPL II CODE	GENERATED LABELS
<pre> ^XA ^FO260,110 ^CFG ^SN001,1,Y^FS ^PQ3 ^XZ </pre> <p><i>Note: The ZPL II code above will generate three separate labels, seen to the right.</i></p>	<div style="border: 1px solid black; padding: 5px; text-align: center; margin-bottom: 5px;">001</div> <div style="border: 1px solid black; padding: 5px; text-align: center; margin-bottom: 5px;">002</div> <div style="border: 1px solid black; padding: 5px; text-align: center;">003</div>

Comments Incrementing and decrementing takes place for each serial-numbered field when all replicates for each serial number have been printed, as specified in parameter *r* of the ^PQ (print quality) command.

If, during the course of printing serialized labels, the printer runs out of either paper or ribbon, the first label printed (after the media or ribbon has been replaced and calibration completed) has the same serial number as the *partial* label printed before the *out* condition occurred. This is done in case the last label before the *out* condition did not fully print. This is controlled by the ^JZ command.

Using Leading Zeros

In the ^SN command, the *z* parameter determines if leading zeros are printed or suppressed. Depending on which value is used (*Y* = print leading zeros; *N* = do not print leading zeros), the printer either prints or suppresses the leading zeros.

The default value for this parameter is *N* (do not print leading zeros).

Print Leading Zeros



In x.13 and earlier, the starting value consists of the right-most consecutive sequence of digits.



In x.14 and later, the starting value consists of the first number working backwards in the backing store consecutive sequence of digits.

The width (number of digits in the sequence) is determined by scanning from right to left until the first non-digit (space or alpha character) is encountered. To create a specific width, manually place leading zeros as necessary.

Suppressing Leading Zeros

.13↓

In x.13 and earlier, the starting value consists of the right-most consecutive sequence of digits, including any leading spaces.

.14↑

In x.14 or later, the starting value consists of the first number working backwards in the backing store consecutive sequence of digits, including any leading spaces.

The starting value consists of the first number working backwards in the backing store consecutive sequence of digits, including any leading spaces. The width (number of digits in the sequence) is determined by scanning from right to left until the first alpha character (except a space) is encountered. To create a specific width, manually place leading spaces or zeros as necessary. Suppressed zeros are replaced by spaces. During the serialization process, when the entire number contains all zeros, the last zero is not suppressed.

The ^SN command replaces the Field Data (^FD) command within a label formatting program.

^SO – Set Offset (for Real-Time Clock)

Description The ^SO command is used to set the secondary and the tertiary offset from the primary Real-Time Clock.



Note • For each label only one S02 command can be used. If more than one offset is required, S03 must be used.

Format ^SOa,b,c,d,e,f,g

Parameters	Details
a = clock set	<p><i>Accepted Values:</i></p> <p>2 = secondary 3 = third</p> <p><i>Default Value:</i> value must be specified</p>
b = months offset	<p><i>Accepted Values:</i> -32000 to 32000</p> <p><i>Default Value:</i> 0</p>
c = days offset	<p><i>Accepted Values:</i> -32000 to 32000</p> <p><i>Default Value:</i> 0</p>
d = years offset	<p><i>Accepted Values:</i> -32000 to 32000</p> <p><i>Default Value:</i> 0</p>
e = hours offset	<p><i>Accepted Values:</i> -32000 to 32000</p> <p><i>Default Value:</i> 0</p>
f = minutes offset	<p><i>Accepted Values:</i> -32000 to 32000</p> <p><i>Default Value:</i> 0</p>
g = seconds offset	<p><i>Accepted Values:</i> -32000 to 32000</p> <p><i>Default Value:</i> 0</p>

For more detail on set offset, see [Real Time Clock](#) on page 1249.

^SP – Start Print

Description The ^SP command allows a label to start printing at a specified point before the entire label has been completely formatted. On extremely complex labels, this command can increase the overall throughput of the print.

The command works as follows: Specify the dot row at which the ^SP command is to begin. This creates a label *segment*. Once the ^SP command is processed, all information in that segment prints. During the printing process, all of the commands after the ^SP continue to be received and processed by the printer.

If the segment after the ^SP command (or the remainder of the label) is ready for printing, media motion does not stop. If the next segment is not ready, the printer stops mid-label and wait for the next segment to be completed. Precise positioning of the ^SP command requires a trial-and-error process, as it depends primarily on print speed and label complexity.

The ^SP command can be effectively used to determine the worst possible print quality. You can determine whether using the ^SP command is appropriate for the particular application by using this procedure.

If you send the label format up to the first ^SP command and then wait for printing to stop before sending the next segment, the printed label is a sample of the worst possible print quality. It drops any field that is out of order.

If the procedure above is used, the end of the label format must be:

```
^SP#^FS
```

Comments ^SPa

Parameters	Details
a = dot row to start printing	<i>Accepted Values:</i> 0 to 32000 <i>Default Value:</i> 0



Example • In this example, a label 800 dot rows in length uses `^SP500`. Segment 1 prints while commands in Segment 2 are being received and formatted.

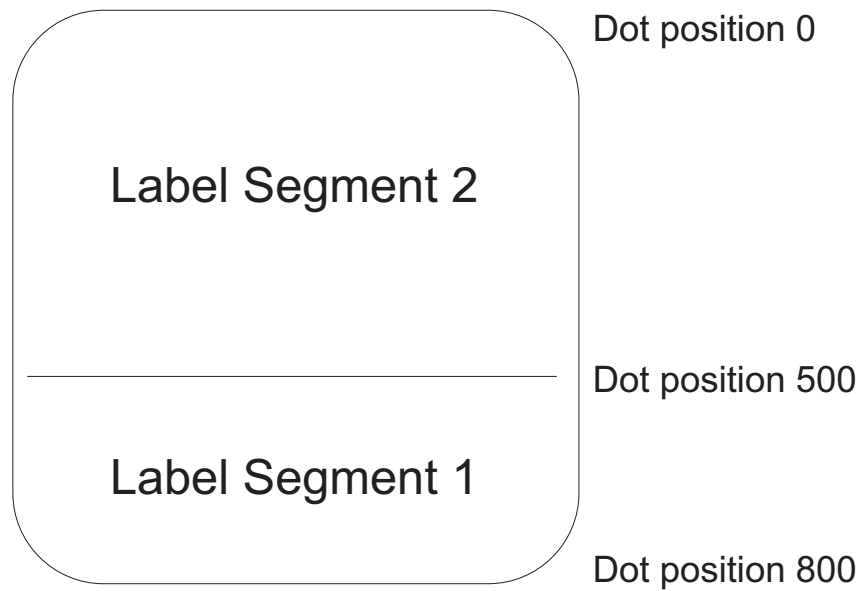

^SQ – Halt ZebraNet Alert

Description The ^SQ command is used to stop the ZebraNet Alert option.

Format ^SQa,b,c

Parameters	Details
a = condition type	<p><i>Accepted Values:</i></p> <ul style="list-style-type: none"> A = paper out B = ribbon out C = printhead over-temp D = printhead under-temp E = head open F = power supply over-temp G = ribbon-in warning (Direct Thermal Mode) H = rewind full I = cut error J = printer paused K = PQ job completed L = label ready M = head element out N = ZBI (Zebra BASIC Interpreter) runtime error O = ZBI (Zebra BASIC Interpreter) forced error Q = clean printhead R = media low S = ribbon low T = replace head U = battery low V = RFID error (in RFID printers only) W = all errors (in RFID printers only) * = all errors (in non-RFID printers)
b = destination	<p><i>Accepted Values:</i></p> <ul style="list-style-type: none"> A = serial port B = parallel port C = e-mail address D = TCP/IP E = UDP/IP F = SNMP trap * = wild card to stop alerts for all destinations
c = halt messages	<p><i>Accepted Values:</i></p> <ul style="list-style-type: none"> Y = halt messages N = start messages <p><i>Default Value:</i> Y</p>

^SR – Set Printhead Resistance

Description The ^SR command allows you to set the printhead resistance.

Format ^SR####

Parameters	Details
#### = resistance value (four-digit numeric value)	<i>Accepted Value: 0488 to 1175</i> <i>Default Value: last permanently saved value</i>

Comments To avoid damaging the printhead, this value should be less than or equal to the value shown on the printhead being used. Setting a higher value could damage the printhead.



Note • New printer models automatically set head resistance.

[^]SS – Set Media Sensors

Description The [^]SS command is used to change the values for media, web, ribbon, and label length set during the media calibration process. The media calibration process is described in your specific printer’s user’s guide.

Format [^]SSw,m,r,l,m2,r2,a,b,c

Parameters	Details
w = web (three-digit value)	<i>Accepted Values: 000 to 100</i> <i>Default Value:</i> value shown on the media sensor profile or configuration label
m = media (three-digit value)	<i>Accepted Values: 000 to 100</i> <i>Default Value:</i> value shown on the media sensor profile or configuration label
r = ribbon (three-digit value)	<i>Accepted Values: 000 to 100</i> <i>Default Value:</i> value shown on the media sensor profile or configuration label
l = label length (in dots, four-digit value)	<i>Accepted Values: 0001 to 32000</i> <i>Default Value:</i> value calculated in the calibration process
m2 = intensity of media LED (three-digit value)	<i>Accepted Values: 000 to 255</i> <i>Default Value:</i> value calculated in the calibration process
r2 = intensity of ribbon LED (three-digit value)	<i>Accepted Values: 000 to 255</i> <i>Default Value:</i> value calculated in the calibration process
a = mark sensing (three-digit value)	<i>Accepted Values: 000 to 100</i> <i>Default Value:</i> value calculated in the calibration process
b = mark media sensing (three-digit value)	<i>Accepted Values: 000 to 100</i> <i>Default Value:</i> value calculated in the calibration process
c = mark LED sensing (three-digit value)	<i>Accepted Values: 000 to 255</i> <i>Default Value:</i> value calculated in the calibration process

➔ **Example** • Below is an example of a media sensor profile. Notice the numbers from 000 to 100 and where the words WEB, MEDIA, and RIBBON appear in relation to those numbers. Also notice the black vertical spike. This represents where the printer sensed the transition from media-to-web-to-media.

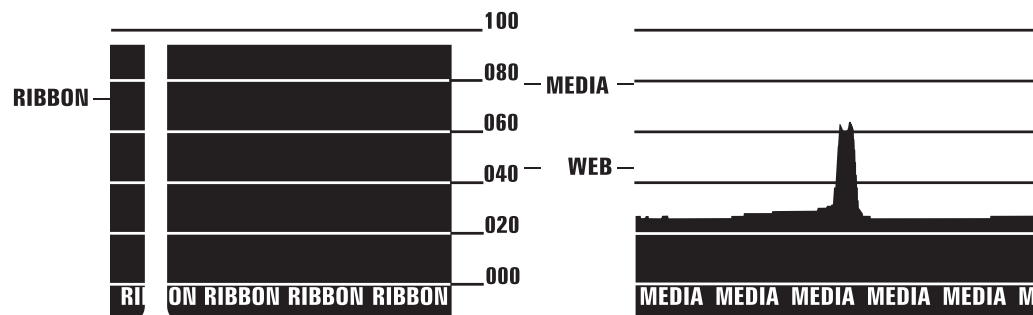

The media and sensor profiles produced vary in appearance from printer to printer.

Comments The `m2` and `r2` parameters have no effect in Stripe[®] S-300 and S-500 printers.

This command is ignored on the HC100[™] printer.

Maximum values for parameters depend on which printer platform is being used.

^ST – Set Date and Time (for Real-Time Clock)

Description The ^ST command sets the date and time of the Real-Time Clock.

Format ^STa,b,c,d,e,f,g

Parameters	Details
a = month	<i>Accepted Values:</i> 01 to 12 <i>Default Value:</i> current month
b = day	<i>Accepted Values:</i> 01 to 31 <i>Default Value:</i> current day
c = year	<i>Accepted Values:</i> 1998 to 2097 <i>Default Value:</i> current year
d = hour	<i>Accepted Values:</i> 00 to 23 <i>Default Value:</i> current hour
e = minute	<i>Accepted Values:</i> 00 to 59 <i>Default Value:</i> current minute
f = second	<i>Accepted Values:</i> 00 to 59 <i>Default Value:</i> current second
g = format	<i>Accepted Values:</i> A = a.m. P = p.m. M = 24-hour military <i>Default Value:</i> M

For more details on set date and time, see [Real Time Clock](#) on page 1249.

^SX – Set ZebraNet Alert

Description The ^SX command is used to configure the ZebraNet Alert System.

Format ^SXa,b,c,d,e,f



Note • The values in this table apply to firmware version V48.12.4 or later.

Parameters	Details
a = condition type	<p><i>Accepted Values:</i></p> <ul style="list-style-type: none"> A = paper out B = ribbon out C = printhead over-temp D = printhead under-temp E = head open F = power supply over-temp G = ribbon-in warning (Direct Thermal Mode) H = rewind full I = cut error J = printer paused K = PQ job completed L = label ready M = head element out N = ZBI (Zebra BASIC Interpreter) runtime error O = ZBI (Zebra BASIC Interpreter) forced error P = power on Q = clean printhead R = media low S = ribbon low T = replace head U = battery low V = RFID error (in RFID printers only) * = all errors <p><i>Default Value:</i> if the parameter is missing or invalid, the command is ignored</p>
b = destination for route alert	<p><i>Accepted Values:</i></p> <ul style="list-style-type: none"> A = serial port B* = parallel port C = e-mail address D = TCP/IP E = UDP/IP F = SNMP trap <p><i>Default Value:</i> if this parameter is missing or invalid, the command is ignored</p> <p>* Requires bidirectional communication.</p>

Parameters	Details
c = enable <i>condition set</i> alert to this destination	<p><i>Accepted Values:</i></p> <p>N = no Y = yes</p> <p><i>Default Value:</i> Y or previously configured value</p>
d = enable condition clear alert to this destination	<p><i>Accepted Values:</i></p> <p>N = no Y = yes</p> <p><i>Default Value:</i> N or previously configured value</p> <p>Parameters e and f are sub-options based on destination. If the sub-options are missing or invalid, these parameters are ignored.</p>
e = destination setting	<p><i>Accepted Values:</i></p> <p>Internet e-mail address (e.g. user@company.com) IP address (for example, 10.1.2.123) SNMP trap IP or IPX addresses</p>
f = port number	<p><i>Accepted Values:</i></p> <p>TCP port # (0 to 65535) UDP port # (0 to 65535)</p>



Example • This is an example of the different (b) destinations that you can send for the condition type (a):

Serial: ^SXA,A,Y,Y
 Parallel: ^SXA,B,Y,Y
 E-Mail: ^SXA,C,Y,Y,admin@company.com
 TCP: ^SXA,D,Y,Y,123.45.67.89,1234
 UDP: ^SXA,E,Y,Y,123.45.67.89,1234
 SNMP Trap: ^SXA,F,Y,Y,255.255.255.255

Comments In the example above for SNMP Trap, entering 255.255.255.255 broadcasts the notification to every SNMP manager on the network. To route the device to a single SNMP manager, enter a specific address (123.45.67.89).

^SZ – Set ZPL Mode

Description The ^SZ command is used to select the programming language used by the printer. This command gives you the ability to print labels formatted in both ZPL and ZPL II.

This command remains active until another ^SZ command is sent to the printer or the printer is turned off.

Format ^SZa

Parameters	Details
a = ZPL version	<i>Accepted Values:</i> 1 = ZPL 2 = ZPL II <i>Default Value:</i> 2

Comments If the parameter is missing or invalid, the command is ignored.

~TA – Tear-off Adjust Position

Description The ~TA command lets you adjust the rest position of the media after a label is printed, which changes the position at which the label is torn or cut.

Format ~TA###



Important • These are some important facts about this command:

- For 600 dpi printers, the step size doubles.
- If the number of characters is **less than** 3, the command is ignored.

Parameters	Details
### = change in media rest position (3-digit value in dot rows must be used.)	<i>Accepted Values:</i> -120 to 120 0 to 120 (on the HC100) <i>Default Value:</i> last permanent value saved

Comments If the parameter is missing or invalid, the command is ignored.

^TB – Text Blocks



This command is available only for printers with firmware version V60.14.x, V50.14.x, or later.

Description The ^TB command prints a text block with defined width and height. The text block has an automatic word-wrap function. If the text exceeds the block height, the text is truncated. This command supports complex text layout features.



Note • ^TB is the preferred command for printing fields or blocks of text, instead of ^FB.

Format ^TBa,b,c

Parameters	Details
a = block rotation	<p><i>Accepted Values:</i></p> <ul style="list-style-type: none"> N = normal R = rotate 90 degrees clockwise I = invert 180 degrees B = read from bottom up-270 degrees <p><i>Default Value:</i> whatever was specified by the last ^A (which has the default of ^FW)</p>
b = block width in dots	<p><i>Accepted Values:</i></p> <ul style="list-style-type: none"> 1 to the width of the label in dots <p><i>Default Value:</i> 1 dot</p>
c = block height in dots	<p><i>Accepted Values:</i></p> <ul style="list-style-type: none"> 1 to the length of the label in dots <p><i>Default Value:</i> 1 dot</p>

Comments Facts about the ^TB command:

- Justification of ^TB command comes from ^FO, ^FT, or ^FN command. If no justification is determined then the default is auto justification.
- Data between < and > is processed as an escape sequence; for example, <<> will print <.
- The ^TB command has an automatic word-wrap function. Soft hyphens do not print and are not used as a line break position.

^TO – Transfer Object

Description The ^TO command is used to copy an object or group of objects from one storage device to another. It is similar to the copy function used in PCs.

Source and destination devices must be supplied and must be different and valid for the action specified. Invalid parameters cause the command to be ignored.

The asterisk (*) can be used as a wild card for object names and extensions. For instance, ZEBRA.* or *.GRF are acceptable forms for use with the ^TO command.

At least one source parameter (**d**, **o**, or **x**) and one destination parameter (**s**, **o**, or **x**) must be specified. If only ^TO is entered, the command is ignored.

Format ^TOs:o.x,d:o.x

Parameters	Details
s = source device of stored object	<i>Accepted Values:</i> R:, E:, B:, and A: <i>Default Value:</i> if a drive is not specified, all objects are transferred to the drive set in parameter s
o = stored object name	<i>Accepted Values:</i> any existing object conforming to Zebra conventions <i>Default Value:</i> if a name is not specified, * is used — all objects are selected
x = extension	<i>Accepted Values:</i> any extension conforming to Zebra conventions <i>Default Value:</i> if an extension is not specified, * is used — all extensions are selected
d = destination device of the stored object	<i>Accepted Values:</i> R:, E:, B:, and A: <i>Default Value:</i> a destination must be specified
o = name of the object at destination	<i>Accepted Values:</i> up to 8 alphanumeric characters <i>Default Value:</i> if a name is not specified, the name of the existing object is used
x = extension	<i>Accepted Values:</i> any extension conforming to Zebra conventions <i>Default Value:</i> if an extension is not specified, the extension of the existing object is used

Comments Parameters **o**, **x**, and **s** support the use of the wild card (*).

If the destination device does not have enough free space to store the object being copied, the command is canceled.

Zebra files (Z:*.*) cannot be transferred. These files are copyrighted by Zebra Technologies.

Transferring Objects

These are some examples of using the ^TO command.



Example 1 • To copy the object **ZLOGO.GRF** from DRAM to an optional Memory Card and rename it **ZLOGO1.GRF**, write the following format:

```
^XA
^TOR:ZLOGO.GRF,B:ZLOGO1.GRF
^XZ
```



Example 2 • To copy the object **SAMPLE.GRF** from an optional Memory Card to DRAM and keep the same name, write this format:

```
^XA
^TOB:SAMPLE.GRF,R:SAMPLE.GRF
^XZ
```

Transferring Multiple Objects

The asterisk (*) can be used to transfer multiple object files (except *.FNT) from DRAM to the Memory Card. For example, assume you have several object files that contain logos. These files are named **LOGO1.GRF**, **LOGO2.GRF**, and **LOGO3.GRF**.

To transfer all these files to the memory card using the name **NEW** instead of **LOGO**, place an asterisk after the names **NEW** and **LOGO** in the transfer command. This copies all files beginning with **LOGO** in one command.

```
^XA
^TOR:LOGO*.GRF,B:NEW*.GRF
^XZ
```

During a multiple transfer, if a file is too big to be stored on the memory card, that file is skipped. All remaining files attempt to be transferred. All files that can be stored within the space limitations are transferred, while other files are ignored.

~WC – Print Configuration Label

Description The ~WC command is used to generate a printer configuration label. The printer configuration label contains information about the printer setup, such as sensor type, network ID, ZPL mode, firmware version, and descriptive data on the R:, E:, B:, and A: devices.

Format ~WC

Comments This command works only when the printer is idle.

PRINTER CONFIGURATION	
Zebra Technologies	
ZTC Z4MPlus-200 dpi	
140xIIIplus	
Zebra	
+12.....	DARKNESS
6 IPS.....	PRINT SPEED
+000.....	TEAR OFF
TEAR OFF.....	PRINT MODE
CONTINUOUS.....	MEDIA TYPE
WEB.....	SENSOR TYPE
AUTO SELECT.....	SENSOR SELECT
THERMAL-TRANS.....	PRINT METHOD
101 4/8 MM.....	PRINT WIDTH
2000.....	LABEL LENGTH
39.0IN 988MM.....	MAXIMUM LENGTH
BIDIRECTIONAL.....	PARALLEL COMM.
RS232.....	SERIAL COMM.
9600.....	BAUD
8 BITS.....	DATA BITS
NONE.....	PARITY
XON/XOFF.....	HOST HANDSHAKE
NONE.....	PROTOCOL
000.....	NETWORK ID
NORMAL MODE.....	COMMUNICATIONS
<~> 7EH.....	CONTROL PREFIX
<^> 5EH.....	FORMAT PREFIX
<, > 2CH.....	DELIMITER CHAR
ZPL II.....	ZPL MODE
CALIBRATION.....	MEDIA POWER UP
CALIBRATION.....	HEAD CLOSE
DEFAULT.....	BACKFEED
+000.....	LABEL TOP
+0020.....	LEFT POSITION
DISABLED.....	REPRINT MODE
070.....	WEB S.
070.....	MEDIA S.
072.....	RIBBON S.
100.....	TAKE LABEL
015.....	MEDIA LED
103.....	RIBBON LED
+10.....	LCD ADJUST
DPSWFXM.....	MODES ENABLED
.....	MODES DISABLED
832 8/MM FULL.....	RESOLUTION
V60.14.5Z <-.....	FIRMWARE
V23 ---- 57.....	HARDWARE ID
CUSTOMIZED.....	CONFIGURATION
3584k.....	R: RAM
2048k.....	E: ONBOARD FLASH
NONE.....	FORMAT CONVERT
CUTTER.....	OPTION
FW VERSION.....	IDLE DISPLAY
04/03/07.....	RTC DATE
15:51.....	RTC TIME
NO.....	RFID READY
SELECTED ITEMS.....	PASSWORD LEVEL
GL 47277.04MS050224.79000.04.VH2....	

FIRMWARE IN THIS PRINTER IS COPYRIGHTED

^WD – Print Directory Label

Description The ^WD command is used to print a label listing bar codes, objects stored in DRAM, or fonts.

For bar codes, the list shows the name of the bar code. For fonts, the list shows the name of the font, the number to use with ^A command, and size. For objects stored in DRAM, the list shows the name of the object, extension, size, and option flags. All lists are enclosed in a double-line box.

Format ^WDd:o.x

Parameters	Details
d = source device — optional	<i>Accepted Values:</i> R:, E:, B:, A: and Z: <i>Default Value:</i> R:
o = object name — optional	<i>Accepted Values:</i> 1 to 8 alphanumeric characters <i>Default Value:</i> * The use of a ? (question mark) is also allowed.
x = extension — optional	<i>Accepted Values:</i> any extension conforming to Zebra conventions .FNT = font .BAR = bar code .ZPL = stored ZPL format .GRF = GRF graphic .CO = memory cache .DAT = font encoding .BAS = ZBI encrypted program .BAE = ZBI encrypted program .STO = data storage .PNG = PNG graphic * = all objects .TTF = TrueType Font .TTE = True Type Extension <i>Default Value:</i> * The use of a ? (question mark) is also allowed.

.14↑

.TTF and .TTE are only supported in firmware version V60.14.x, V50.14.x, or later.

➔ **Example 1** • To print a label listing all objects in DRAM, enter:

```
^XA
^WDR:*. *
^XZ
```

➔ **Example 2** • To print a label listing all resident bar codes, enter:

```
^XA
^WDZ:*.BAR
^XZ
```

➔ **Example 3** • To print a label listing all resident fonts, enter:

```
^XA
^WDZ:*.FNT
^XZ
```

~WQ – Write Query

Description The ~WQ command triggers the printer to print a label with odometer, maintenance or alert, and printhead history information.

Supported Devices

- Xi4 with firmware V53.17.1Z or later
- RXi4 with firmware V53.17.7Z or later
- ZM400/ZM600 with firmware V53.15.xZ or later
- RZ400/RZ600 with firmware R53.15.xZ or later
- S4M with firmware V53.15.4Z or later
- G-Series

Format ~WQquery-type

Parameter	Details
query-type	<p>For detailed examples of these parameters, see ~WQ Examples on page 367.</p> <p><i>Accepted Values:</i></p> <p>ES = requests the printer’s status. For details see, Table 16 on page 365 and Table 17 on page 366.</p> <p>HA = hardware address of the internal wired print server</p> <p>JT = requests a summary of the printer’s printhead test results</p> <p>MA = maintenance alert settings</p> <p>MI = maintenance information</p> <p>OD = odometer</p> <p>PH = printhead life history</p> <p>PP = printer’s Plug and Play string</p> <p>SN = printer’s serial number</p> <p>UI = printer’s USB product ID and BCD release version</p> <p><i>Default Value:</i> must be an accepted value or the command is ignored</p>

Table 16 • Error Flags (~WQES)

Error Flags	Flag	Group 2	Group 1 (X = Value can be any hexadecimal number [0-9, A-F])							
		Nibbles16 -9	Nibble 8	Nibble 7	Nibble 6	Nibble 5	Nibble 4	Nibble 3	Nibble 2	Nibble 1
No Error	0	00000000	0	0	0	0	0	0	0	0
Error Present	1	00000000	X	X	X	X	X	X	X	X
Printhead Thermistor Open	1	00000000	X	X	X	X	X	2	X	X
Invalid Firmware Config.	1	00000000	X	X	X	X	X	1	X	X
Printhead Detection Error	1	00000000	X	X	X	X	X	X	8	X
Bad Printhead Element	1	00000000	X	X	X	X	X	X	4	X
Motor Over Temperature	1	00000000	X	X	X	X	X	X	2	X

a. This error flag is supported only on KR403 printers.

Table 16 • Error Flags (~WQES)

Error Flags	Flag	Group 2	Group 1 (X = Value can be any hexadecimal number [0-9, A-F])								
		Nibbles16 -9	Nibble 8	Nibble 7	Nibble 6	Nibble 5	Nibble 4	Nibble 3	Nibble 2	Nibble 1	
Printhead Over Temperature	1	00000000	X	X	X	X	X	X	X	1	X
Cutter Fault	1	00000000	X	X	X	X	X	X	X	X	8
Head Open	1	00000000	X	X	X	X	X	X	X	X	4
Ribbon Out	1	00000000	X	X	X	X	X	X	X	X	2
Media Out	1	00000000	X	X	X	X	X	X	X	X	1
Clear Paper Path Failed ^a	1 ^a	00000000	X	X	X	X	8 ^a	X	X	X	X
Paper Feed Error ^a	1 ^a	00000000	X	X	X	X	4 ^a	X	X	X	X
Presenter Not Running ^a	1 ^a	00000000	X	X	X	X	2 ^a	X	X	X	X
Paper Jam during Retract ^a	1 ^a	00000000	X	X	X	X	1 ^a	X	X	X	X
Black Mark not Found ^a	1 ^a	00000000	X	X	X	8 ^a	X	X	X	X	X
Black Mark Calabrate Error ^a	1 ^a	00000000	X	X	X	4 ^a	X	X	X	X	X
Retract Function timed out ^a	1 ^a	00000000	X	X	X	2 ^a	X	X	X	X	X
Paused ^a	1 ^a	00000000	X	X	X	1 ^a	X	X	X	X	X

a. This error flag is supported only on KR403 printers.

Table 17 • Warning Flags (~WQES)

Error Flags	Flag	Group 2	Group 1 (X = Value can be any hexadecimal number [0-9, A-F])								
		Nibbles16 -9	Nibble 8	Nibble 7	Nibble 6	Nibble 5	Nibble 4	Nibble 3	Nibble 2	Nibble 1	
No Warning	0	00000000	0	0	0	0	0	0	0	0	0
Warning Present	1	00000000	X	X	X	X	X	X	X	X	X
Paper-near-end Sensor ^b	1 ^b	00000000	X	X	X	X	X	X	X	X	8 ^b
Replace Printhead	1	00000000	X	X	X	X	X	X	X	X	4
Clean Printhead	1	00000000	X	X	X	X	X	X	X	X	2
Need to Calibrate Media	1	00000000	X	X	X	X	X	X	X	X	1
Sensor 1 (Paper before head) ^b	1 ^b	00000000	X	X	X	X	X	X	1 ^b	X	X
Sensor 2 (Black mark) ^b	1 ^b	00000000	X	X	X	X	X	X	2 ^b	X	X
Sensor 3 (Paper after head) ^b	1 ^b	00000000	X	X	X	X	X	X	4 ^b	X	X
Sensor 4 (loop ready) ^b	1 ^b	00000000	X	X	X	X	X	X	8 ^b	X	X
Sensor 5 (presenter) ^b	1 ^b	00000000	X	X	X	X	X	1 ^b	X	X	X
Sensor 6 (retract ready) ^b	1 ^b	00000000	X	X	X	X	X	2 ^b	X	X	X
Sensor 7 (in retract) ^b	1 ^b	00000000	X	X	X	X	X	4 ^b	X	X	X
Sensor 8 (at bin) ^b	1 ^b	00000000	X	X	X	X	X	8 ^b	X	X	X

b. This error flag is supported only on KR403 printers.

~WQ Examples

This section provides detailed examples of all the available parameters.



Example 1 • This example shows how to request the printer's status.

- To request the printer's status, type `~WQES`

A label similar to this prints out:

```

PRINTER STATUS
ERRORS:      1 00000000 00000005
WARNINGS:    1 00000000 00000002
    
```

In this example, the Printer Status resolves to these conditions:

- The cover/printhead is open (value = 4).
- Media is out or not loaded into the printer (value = 1).
- The printhead needs to be cleaned (value = 2).
- Error nibble 1 is equal to 5 when the error status values are added together (4+1).

This illustration identifies the printer status definitions:

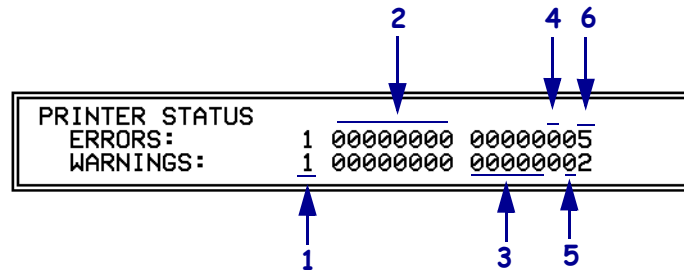

1	Flag
2	Nibble 16-9
3	Nibble 8-4
4	Nibble 3
5	Nibble 2
6	Nibble 1



Example 2 • This example shows how to request the printer’s status.

1. To request the printer’s status, type `~WQES`

A label similar to this prints out:

```

PRINTER STATUS
ERRORS:      1 00000000 0000000B
WARNINGS:    0 00000000 00000000
    
```

In the example shown above, the Printer Status resolves to the following conditions:

- The cutter has a fault. (value = 8).
- Ribbon is out or not loaded into the printer (value = 2).
- Media is out or not loaded into the printer (value = 1).
- Error byte 1 is equal to B when the error status values are added together (8 + 2 + 1 = hexadecimal B).



Example 3 • This is an example of how to print the hardware address of the internal wired print server.

1. To print the hardware address of the internal wired print server, type `~WQHA`

A label similar to this prints out:

```

MAC ADDRESS
00:07:4d:2c:e0:7a
    
```



Example 4 • This is an example of how to print a summary of the printer’s printhead test results.

The `^JT` command is used to initiate printhead testing, set the testing interval, and set the element range to be tested. For more details see, [^JT on page 276](#).

1. To request a summary of the printer’s printhead test, type `~WQJT`

A label similar to this prints out:

```

PRINT HEAD TEST RESULTS
0,A,0000,0000,0000
    
```

When the printer has printed enough labels to trigger a printhead test, the initial data changes.

1. To request a summary of the printer’s printhead test, type `~WQJT`

A label similar to this prints out:

```

PRINT HEAD TEST RESULTS
0,A,0015,0367,0000
    
```

This illustration identifies the printhead test field definitions:

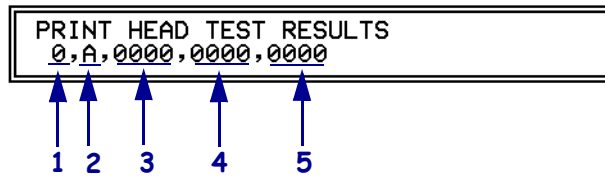

1	Element failure
2	Manual (M) or automatic (A) range
3	First test element
4	Last test element
5	Failure count

➔ **Example 5** • This is an example of how to print the maintenance alert query for the ~WQ command.

- To get the current settings, type ~WQMA
A label similar to this prints out:

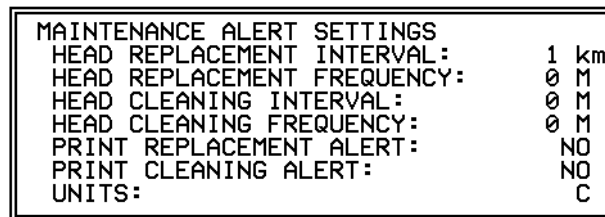



Example 6 • This is an example of how to use the odometer query for the ~WQ command. Note that the units of measure are controlled by the ^MA command. Also, if the "Early Warning Maintenance State" is turned "ON" the printer response would also list LAST CLEANED and CURRENT PRINTHEAD LIFE counters.

1. To get the current settings, type ~WQOD

A label similar to this prints out:

```

PRINT METERS
TOTAL NONRESETTABLE:      8560  "
USER RESETTABLE CNTR1:    9     "
USER RESETTABLE CNTR2:    8560  "
    
```

The units of measure are set to inches.

1. To change the units of measure to centimeters, type:

```

^XA^MA,,,,C
^XZ
    
```

The units of measure are set to centimeters.

2. To check the settings, type ~WQOD.

A label similar to this prints out:

```

PRINT METERS
TOTAL NONRESETTABLE:      21744 cm
USER RESETTABLE CNTR1:    24   cm
USER RESETTABLE CNTR2:    21744 cm
    
```



Example 7 • This is an example of how to print the maintenance information query for the ~WQ command. Note that the message is controlled by the ^MI command.

1. To get the current settings, type ~WQMI

A label similar to this prints out:

```

MAINTENANCE ALERT MESSAGES
CLEAN: PLEASE CLEAN PRINT HEAD
REPLACE: PLEASE REPLACE PRINT HEAD
    
```



Example 8 • This is an example of how to print the printhead life query for the ~WQ command. Note that the units of measure are controlled by the ^MA command.

1. To get the current settings, type ~WQPH

A label similar to this prints out:

```

LAST CLEANED:                257  "
HEAD LIFE HISTORY
#  DISTANCE
1 → 1:      257  "
2 → 2:     1489  "
   3:     7070  "
    
```

1	The current life of the print head.
2	Line items 2 through 10 (the example only shows 2 through 3) tracks the measurement for each time the print head is changed.

→ **Example 9** • This is an example of how to print the printer's Plug and Play string.

1. To print the printer's Plug and Play string, type `~WQPP`

A label similar to this prints out:

```
PLUG AND PLAY MESSAGES
MFG: Zebra Technologies
CMD: ZPL
MDL: Gx420d
```

→ **Example 10** • This is an example of how to print the printer's serial number.

1. To get the printer's serial number, type `~WQSN`

A label similar to this prints out:

```
SERIAL NUMBER
30A07070005
```

→ **Example 11** • This is an example of how to print the printer's USB product ID and BCD release version.

1. To print the printer's USB product ID and BCD release version, type `~WQUI`

A label similar to this prints out:

```
USB INFORMATION
PID: 0084
RELEASE VERSION: 15.01
```

^XA – Start Format

Description The ^XA command is used at the beginning of ZPL II code. It is the opening bracket and indicates the start of a new label format. This command is substituted with a single ASCII control character STX (control-B, hexadecimal 02).

Format ^XA

Comments Valid ZPL II format requires that label formats should start with the ^XA command and end with the ^XZ command.

^XB – Suppress Backfeed

Description The ^XB command suppresses forward feed of media to tear-off position depending on the current printer mode. Because no forward feed occurs, a backfeed before printing of the next label is not necessary; this improves throughput. When printing a batch of labels, the last label should not contain this command.

Format ^XB

^XB in the Tear-off Mode

Normal Operation: backfeed, print, and feed to rest

^XB Operation: print (Rewind Mode)

^XB in Peel-off Mode

Normal Operation: backfeed, print, and feed to rest

^XB Operation: print (Rewind Mode)



Note • To prevent jamming in cutter mode, ^XB suppresses backfeed and cutting.

^XF – Recall Format

Description The ^XF command recalls a stored format to be merged with variable data. There can be multiple ^XF commands in one format, and they can be located anywhere within the code.

When recalling a stored format and merging data using the ^FN (Field Number) function, the calling format must contain the ^FN command to merge the data properly.

While using stored formats reduces transmission time, no formatting time is saved. The ZPL II format being recalled is saved as text strings that need to be formatted at print time.

Format ^XFd:o.x

Parameters	Details
d = source device of stored image	<i>Accepted Values:</i> R:, E:, B:, and A: <i>Default Value:</i> search priority (R:, E:, B:, and A:)
o = name of stored image	<i>Accepted Values:</i> 1 to 8 alphanumeric characters <i>Default Value:</i> if a name is not specified, UNKNOWN is used
x = extension l	<i>Fixed Value:</i> .ZPL

For a complete example of the ^DF and ^XF command, see [^DF and ^XF — Download format and recall format on page 56](#).

^XG – Recall Graphic

Description The ^XG command is used to recall one or more graphic images for printing. This command is used in a label format to merge graphics, such as company logos and piece parts, with text data to form a complete label.

An image can be recalled and resized as many times as needed in each format. Other images and data might be added to the format.

Format ^XGd:o.x,mx,my

Parameters	Details
d = source device of stored image	<i>Accepted Values:</i> R:, E:, B:, and A: <i>Default Value:</i> search priority (R:, E:, B:, and A:)
o = name of stored image	<i>Accepted Values:</i> 1 to 8 alphanumeric characters <i>Default Value:</i> if a name is not specified, UNKNOWN is used
x = extension l	<i>Fixed Value:</i> .GRF
mx = magnification factor on the x-axis	<i>Accepted Values:</i> 1 to 10 <i>Default Value:</i> 1
my = magnification factor on the y-axis	<i>Accepted Values:</i> 1 to 10 <i>Default Value:</i> 1



Example • This is an example of using the ^XG command to recall the image SAMPLE.GRF from DRAM and print it in five different sizes in five different locations on the same label:

```

^XA
^F0100,100^XGR:SAMPLE.GRF,1,1^FS
^F0100,200^XGR:SAMPLE.GRF,2,2^FS
^F0100,300^XGR:SAMPLE.GRF,3,3^FS
^F0100,400^XGR:SAMPLE.GRF,4,4^FS
^F0100,500^XGR:SAMPLE.GRF,5,5^FS
^XZ

```

^XS – Set Dynamic Media Calibration

Description The ^XS command controls whether dynamic media calibration is performed to compensate for variations in label length, position, transmissivity, and/or reflectance after a printer is powered-up or the printer has been opened (for example to change or check the media).

Supported Devices

- G-Series

Format ^XSlength,threshold

Parameters	Details
length = dynamic length calibration	<i>Accepted Values:</i> Y = enable N = disable <i>Default Value:</i> Y
threshold = dynamic threshold calibration	<i>Accepted Values:</i> Y = enable N = disable <i>Default Value:</i> Y
gain = dynamic gain calibration (to be in a future implementation)	<i>Accepted Values:</i> Y = enable N = disable <i>Default Value:</i> Y

^XZ - End Format

Description The ^XZ command is the ending (closing) bracket. It indicates the end of a label format. When this command is received, a label prints. This command can also be issued as a single ASCII control character ETX (Control-C, hexadecimal 03).

Format ^XZ

Comments Label formats must start with the ^XA command and end with the ^XZ command to be in valid ZPL II format.

^ZZ – Printer Sleep

Description The ^ZZ command places the printer in an idle or shutdown mode.

Format ^ZZt,b

Parameters	Details
t = number of second (idle time) prior to shutdown	<i>Accepted Values:</i> 0 to 999999 – setting 0 disables automatic shutdown <i>Default Value:</i> last permanently saved value or 0
b = label status at shutdown	<i>Accepted Values:</i> Y = indicates to shutdown when labels are still queued N = indicates all labels must be printed before shutting down <i>Default Value:</i> N

Comments The ^ZZ command is only valid on the PA400 and PT400 battery-powered printers.

ZPL RFID Commands

This section contains the ZPL II commands for RFID-specific applications.

For additional information, refer to the *RFID Programming Guide* for your printer. A copy is available on the User CD provided with your printer and online at <http://www.zebra.com/manuals>.

RFID Command Overview

In addition to reading or encoding RFID tags, the RFID ZPL commands also provide for RFID exception handling, such as setting the number of read/write retries before declaring a transponder defective (set with `^RR`, `^RT`, and `^WT`) or setting the number of labels that will be attempted if an error occurs (set with `^RS`).

For example, if an RFID label fails to program correctly or if the transponder cannot be detected, the printer ejects the label and prints VOID across it. The printer will try to print another label with the same data and format for the number of RFID labels specified by the `^RS` command. If the problem persists, the printer follows the error handling instructions specified by the `^RS` command: the printer may remove the problematic format from the print queue and proceed with the next format (if one exists in the buffer), or it may place the printer in Pause or Error mode.

If a parameter is designated as *not applicable* for a particular printer, any value entered for the parameter will be ignored, but the place holder for the field is required.

Printer and Firmware Compatibility

Before using a particular command, verify that it is compatible with your printer and firmware version. See the following tables:

- [Table 18, ZD500R Series Printer Command and Firmware Compatibility on page 381](#)
- [Table 19, RXi Series Printer Command and Firmware Compatibility on page 382](#)
- [Table 20, RZ Series and R110PAX4 Printer Command and Firmware Compatibility on page 383](#)
- [Table 21, R4Mplus, RP4T, and R2844-Z Printer Command and Firmware Compatibility on page 384](#)

Table 18 • ZD500R Series Printer Command and Firmware Compatibility

Command	Function	ZD500R
		Firmware
		all
^HL or ~HL on page 385	Return RFID Data Log to Host	*
^HR on page 387	Calibrate RFID Tag Position	*
^HV on page 238	Host Verification	*
^RA on page 394	Read AFI or DSFID Byte	—
^RB on page 395	Define EPC Data Structure	*
^RE on page 397	Enable/Disable E.A.S. Bit	—
^RF on page 398	Read or Write RFID Format	*
^RI on page 402	Get RFID Tag ID	—
^RL on page 403	Lock/Unlock RFID Tag Memory	*
^RM on page 405	Enable RFID Motion	—
^RN on page 406	Detect Multiple RFID Tags in Encoding Field	—
~RO on page 335	Reset Advanced Counters	*
^RQ on page 407	Quick Write EPC Data and Passwords	—
^RR on page 409	Specify RFID Retries for a Block or Enable Adaptive Antenna Selection	—
^RS on page 411	Set Up RFID Parameters	*
^RT on page 418	Read RFID Tag	—
^RU on page 420	Read Unique RFID Chip Serialization	*
~RV on page 422	Report RFID Encoding Results	—
^RW on page 423	Set RF Power Levels for Read and Write	*
^RZ on page 427	Set RFID Tag Password and Lock Tag	—
^WF on page 429	Encode AFI or DSFID Byte	—
^WT on page 430	Write (Encode) Tag	—
^WV on page 432	Verify RFID Encoding Operation	—

* = Supported

— = Not supported

a. Use the ^RF, ^RM, and ^RR commands rather than the ^RT command.

b. Use the ^RF, ^RM, ^RR, and ^WV commands rather than the ^WT command.

Table 19 • RXi Series Printer Command and Firmware Compatibility

Command	Function	R110Xi4	R110Xi HF	R110Xi and R170Xi
		Firmware		
		all	all	all
^HL or ~HL on page 385	Return RFID Data Log to Host	*	*	*
^HR on page 387	Calibrate RFID Tag Position	*	*	*
^RA on page 394	Read AFI or DSFID Byte	—	*	—
^RB on page 395	Define EPC Data Structure	*	*	*
^RE on page 397	Enable/Disable E.A.S. Bit	—	*	—
^RF on page 398	Read or Write RFID Format	*	*	*
^RI on page 402	Get RFID Tag ID	*	*	* (R60.13.0.13ZD or later)
^RL on page 403	Lock/Unlock RFID Tag Memory	—	—	—
^RM on page 405	Enable RFID Motion	*	*	*
^RN on page 406	Detect Multiple RFID Tags in Encoding Field	*	*	* (R60.13.0.3 or later)
~RO on page 335	Reset Advanced Counters	*	*	*
^RQ on page 407	Quick Write EPC Data and Passwords	*	—	* (R60.15.7Z or later)
^RR on page 409	Specify RFID Retries for a Block or Enable Adaptive Antenna Selection	*	*	*
^RS on page 411	Set Up RFID Parameters	*	*	*
^RT on page 418	Read RFID Tag	—	* a	* a
^RU on page 420	Read Unique RFID Chip Serialization	—	—	—
~RV on page 422	Report RFID Encoding Results	*	—	*
^RW on page 423	Set RF Power Levels for Read and Write	*	*	*
^RZ on page 427	Set RFID Tag Password and Lock Tag	*	—	*
^WF on page 429	Encode AFI or DSFID Byte	—	*	—
^WT on page 430	Write (Encode) Tag	—	* b	* b
^WV on page 432	Verify RFID Encoding Operation	—	—	*

* = Supported

— = Not supported

a. Use the ^RF, ^RM, and ^RR commands rather than the ^RT command.

b. Use the ^RF, ^RM, ^RR, and ^WV commands rather than the ^WT command.

Table 20 • RZ Series and R110PAX4 Printer Command and Firmware Compatibility

Command	Function	RZ400 and RZ600		R110PAX4	
		Firmware			
		V53.17.7Z or later	R53.16.X	R62.X.X	R63.X.X
^HL or ~HL on page 385	Return RFID Data Log to Host	*	*	*	*
^HR on page 387	Calibrate RFID Tag Position	*	*	*	*
^RA on page 394	Read AFI or DSFID Byte	—	—	—	—
^RB on page 395	Define EPC Data Structure	*	*	*	*
^RE on page 397	Enable/Disable E.A.S. Bit	—	—	—	—
^RF on page 398	Read or Write RFID Format	*	*	*	*
^RI on page 402	Get RFID Tag ID	*	*	* (R62.13.0.13ZC or later)	* (R63.13.0.11Z or later)
^RL on page 403	Lock/Unlock RFID Tag Memory	—	—	—	—
^RM on page 405	Enable RFID Motion	*	*	*	*
^RN on page 406	Detect Multiple RFID Tags in Encoding Field	*	*	*	—
~RO on page 335	Reset Advanced Counters	*	*	*	*
^RQ on page 407	Quick Write EPC Data and Passwords	*	*	* (R62.15.7Z or later)	—
^RR on page 409	Specify RFID Retries for a Block or Enable Adaptive Antenna Selection	*	*	*	*
^RS on page 411	Set Up RFID Parameters	*	*	*	*
^RT on page 418	Read RFID Tag	* a	* a	* a	* a
^RU on page 420	Read Unique RFID Chip Serialization	—	—	—	—
~RV on page 422	Report RFID Encoding Results	*	*	*	*
^RW on page 423	Set RF Power Levels for Read and Write	*	*	*	*
^RZ on page 427	Set RFID Tag Password and Lock Tag	*	*	*	*
^WF on page 429	Encode AFI or DSFID Byte	—	—	—	—
^WT on page 430	Write (Encode) Tag	* b	* b	* b	* b
^WV on page 432	Verify RFID Encoding Operation	*	*	*	*

* = Supported

— = Not supported

- Use the ^RF, ^RM, and ^RR commands rather than the ^RT command.
- Use the ^RF, ^RM, ^RR, and ^WV commands rather than the ^WT command.
- For parameter e, the only accepted value is N for No Action.

Table 21 • R4Mplus, RP4T, and R2844-Z Printer Command and Firmware Compatibility

Command	Function	R4Mplus					RP4T	R2844-Z
		Firmware						
		SP994X	SP999X	SP1027X	SP1056X	SP1082X	all	all
^HL or ~HL on page 385	Return RFID Data Log to Host	*	*	*	*	*	*	—
^HR on page 387	Calibrate RFID Tag Position	*	*	*	*	*	*	—
^RA on page 394	Read AFI or DSFID Byte	—	—	—	—	—	—	—
^RB on page 395	Define EPC Data Structure	*	*	*	*	*	*	—
^RE on page 397	Enable/Disable E.A.S. Bit	—	—	—	—	—	—	*
^RF on page 398	Read or Write RFID Format	*	*	*	*	*	*	—
^RI on page 402	Get RFID Tag ID	*	*	*	*	*	*	*
^RL on page 403	Lock/Unlock RFID Tag Memory	—	—	—	—	—	—	—
^RM on page 405	Enable RFID Motion	*	*	*	*	*	*	—
^RN on page 406	Detect Multiple RFID Tags in Encoding Field	—	—	—	—	—	*	—
~RO on page 335	Reset Advanced Counters	*	*	*	*	*	*	—
^RQ on page 407	Quick Write EPC Data and Passwords	—	—	—	—	—	*	—
^RR on page 409	Specify RFID Retries for a Block or Enable Adaptive Antenna Selection	*	*	*	*	*	*	—
^RS on page 411	Set Up RFID Parameters	*	*	*	*	*	* c	*
^RT on page 418	Read RFID Tag	* a	* a	* a	* a	* a	* a	*
^RU on page 420	Read Unique RFID Chip Serialization	—	—	—	—	—	—	—
~RV on page 422	Report RFID Encoding Results	* (SP994J or later)	* (SP999C or later)	*	*	*	*	—
^RW on page 423	Set RF Power Levels for Read and Write	*	*	*	*	*	*	—
^RZ on page 427	Set RFID Tag Password and Lock Tag	*	*	*	*	*	*	—
^WF on page 429	Encode AFI or DSFID Byte	—	—	—	—	—	—	—
^WT on page 430	Write (Encode) Tag	* b	* b	* b	* b	* b	* b	*
^WV on page 432	Verify RFID Encoding Operation	*	*	*	*	*	*	—

* = Supported

— = Not supported

- a. Use the ^RF, ^RM, and ^RR commands rather than the ^RT command.
- b. Use the ^RE, ^RM, ^RR, and ^WV commands rather than the ^WT command.
- c. For parameter e, the only accepted value is N for No Action.

^HL or ~HL – Return RFID Data Log to Host

Description The printer continually logs RFID data and stores it in the printer's RAM. This command requests that the RFID data log be returned to the host computer, to clear the current data log, and to restart data recording. The ~HL command is processed immediately, while the ^HL command is processed after all of the previous formats (^XA ... ^XZ) have been processed.

Format ^HL or ~HL

In the log, RFID data displays in this format:

```
[RFID operation],[program position],[antenna element],  
[read or write power],[RFID status],[data]
```

where

[RFID operation]

R = read
W = write
L = lock
S = RFID settings
E = log file reset

[program position],[antenna element],[read or write power]*

Additional information about the program position, the antenna, and the read or write power follows the RFID operation.

Such as:

```
R,F1,D3,27,00000000,DATA
```

where F1 = the program position, D3 = the antenna, and 27 is the write power.

* With some older versions of firmware, these parameters do not display.

[RFID status]

or ##### = an RFID error code (See the *RFID Programming Guide* for your printer for more information on error codes. A copy of the manual is located on the User CD that came with your printer, or you can download a copy from <http://www.zebra.com/manuals>.)

RPWR = read power

WPWR = write power

ANT = antenna

PPOS = program position

FFFFFFFF (or limited to length FFFF for some printers) = indicates that the log file was reset

[data]

the data read or written

Comments

- Data is shown in the format specified by the ^RFW command (ASCII, Hex, or EPC).
- If the log exceeds 64K (approximately 1500 operations), the data log is cleared automatically, and data recording restarts. When this happens, the following appears in the log:
`E,FFFFFFFF,Logfile automatically reset`
- If the printer loses power, the log is lost. If the log results are important to you, retrieve the information frequently.

^HR – Calibrate RFID Tag Position

Description Use this command to initiate tag calibration for RFID media. During the tag calibration process (which can take up to 5 minutes on some printers, depending on the type of RFID inlay and the label size) the printer moves the media, reads the tag's TID to determine chip type, calibrates the RFID tag position, and determines the optimal settings for the RFID media being used. Depending on the printer, these settings include the programming position, the antenna element to use, and the read/write power level to use.



Important • Consider the following before using this command:

- This command is not supported by all printers or firmware. See *Printer and Firmware Compatibility* on page 380 for the list of printers and firmware with which you can use this command.
- For the R110Xi4 and ZD500R printers, leave all transponders before and after the tag that is being calibrated. This allows the printer to determine RFID settings which do not encode the adjacent tag. Allow a portion of media to extend out the front of the printer to allow for backfeed during the tag calibration procedure.
- With some printers, you should not perform transponder calibration for RFID media that meets the transponder placement specifications for your printer because doing so will slow the printer's throughput unnecessarily. For more information about tag calibration, refer to the *RFID Programming Guide* for your printer. A copy of the manual is located on the User CD that came with your printer, or you can download a copy from <http://www.zebra.com/manuals>.

Results of the ^HR tag calibration are returned to the host computer. The "run" option in the `rfid.tag.calibrate` SGD command performs the same calibration but does not create a results table.

To restore the printer's default programming position at any time, use the "restore" option in the `rfid.tag.calibrate` SGD command (see *rfid.tag.calibrate* on page 854).

Format ^HRa,b,c,d,e

Parameters	Details
a = start string	This parameter specifies the user text to appear before the results table. <i>Accepted values:</i> any string less than 65 characters <i>Default value:</i> start
b = end string	This parameter specifies the user text to appear after the results table. <i>Accepted values:</i> any string less than 65 characters <i>Default value:</i> end

Parameters	Details
c = start position	<p>This parameter specifies the start position of the calibration range. All numeric values are in millimeters. Forward or backward designations assume that the label's initial position is with the leading edge at the print line.</p> <p><i>Accepted Values:</i></p> <p>Forward: F0 to Fxxx (where xxx is the label length in millimeters or 999, whichever is less) The printer feeds the label forward for the specified distance and then begins transponder calibration.</p> <p>Backward: B0 to B30 (Not valid on the RP4T printer.) The printer backfeeds the label for the specified distance and then begins transponder calibration. Allow at least 1.25 in. (32 mm) of empty media liner to extend out of the front of the printer.</p> <p><i>Default value:</i></p> <p>For the R110Xi4 and ZD500R: B20 —The printer backfeeds 20 mm before starting transponder calibration.</p> <p>For the ZT400 with RFID option: B30 —The printer backfeeds 30 mm before starting transponder calibration.</p> <p>For all other supported printers: F0—The printer moves the media to the start position relative to the leading edge of the label and then performs the RFID tag calibration.</p>
d = end position	<p>This parameter specifies the end position of the calibration range (last program position to check). All numeric values are in millimeters. Forward or backward designations assume that the label's initial position is with the leading edge at the print line.</p> <p><i>Accepted Values:</i></p> <p>Forward: F0 to Fxxx (where xxx is the label length in millimeters or 999, whichever is less) The printer performs transponder calibration until it reaches the specified end position and then ends the process.</p> <p>Backward: B0 to B30 (Not valid on the RP4T printer.) The printer performs transponder calibration until it reaches the specified end position and then ends the process. Valid only with a backward start position that is greater than the end position.</p> <p>A = Automatic (Valid only on the R110Xi4 and ZD500R printers.) The printer automatically ends the transponder calibration process after successfully reading and encoding a consecutive range of 5 mm on the label. The ZD500R also ensures that no other tags can be programmed at the programming position with the calibration-determined power levels.</p> <p><i>Default value:</i></p> <p>For the R110Xi4 and ZD500R: A</p> <p>For all other supported printers: Label length as shown on the printer configuration label</p>

Parameters	Details
e = antenna and read/write power level detection	 Note • <ul style="list-style-type: none">• This parameter is valid only on the R110Xi4, ZD500R, and ZT400 printers.• The ZD500R printer has only one antenna, so this parameter applies only to the read/write power level settings. <p>This parameter specifies whether to select the antenna and read/write power levels automatically or manually.</p> <p><i>Accepted Values:</i></p> <ul style="list-style-type: none">A = Automatic. The printer automatically scans through the antennas and read/write power during calibration.M = Manual. The printer uses the current antenna and read/write power level settings. <p><i>Default value: A</i></p>



Example 1 • When the printer is using Absolute mode and the following command is sent to the printer:

```
^XA^HR^XZ
```

the printer starts the transponder calibration and returns a results table such as the following:

```
start
position=195
215, ,
214, ,
213, ,
212, ,
211, ,
210, ,W
209,R,
208, ,
207, ,
206, ,W
205,R,
204, ,
203, ,
202, ,W
201,R,W
200,R,W
199,R,W
198,R,W
197,R,W
196,R,W
195,R,W <---****
194,R,W
193,R,W
192,R,W
191,R,W
190,R,W
189,R,
188, ,
187, ,
186, ,
185, ,
.
.
.
end
```

Each line in the results table appears as:

Row, Read Result, Write Result

where

Row = the dot row where calibration occurred

Read Result = results of calibration (R = read, “ ” = unable to read)

Write Result = results of calibration (W = write, “ ” = unable to write)

The optimal programming position is 195. This is identified at the top of the table (**position=195**) and with an the arrow (<---****) in the table.



Example 2 • When the printer is using Relative mode and the following command is sent to the printer:

```
^HRstart,end,B20,F42,M
```

the printer starts the tag calibration and returns a results table such as the following:

```
start
position=F0 MM
leading edge
B20, ,
B19, ,
B18, ,
B17, ,
...
B8, ,
B7, ,
B6, ,
B5, ,
B4,R,W
B3,R,W
B2,R,W
B1,R,W
F0,R,W<---**** F0 MM
F1,R,W
F2,R,W
F3,R,W
F4, ,
F5, ,
F6, ,
F7, ,
F8, ,
F9, ,
F10, ,
...
F38, ,
F39, ,
F40, ,
F41, ,
F42, ,
trailing edge
end
```

Each line in the results table appears as:

Row, Read Result, Write Result

where

Row = the position from the leading edge of the label where calibration occurred

Read Result = results of calibration (R = read, “ ” = unable to read)

Write Result = results of calibration (W = write, “ ” = unable to write)

The optimal programming position is F0 (program with the leading edge of the label at the print line). This is identified at the top of the table (**position=F0 MM**) and with an the arrow (**<---******) in the table.



Example 3 • When the ^HR command is sent to the printer, the printer performs tag calibration and returns a results table such as the following:

```
start
position=B14 MM,A1,18,25
tid information=E200.3414:Alien
leading edge
  Tag 1 ,Tag 2 ,Tag 3 ,Tag 4 ,Tag 5 ,Tag 1 ,Tag 2 ,Tag 3 ,Tag 4 ,Tag 5 ,
EPC,7109 ,BA29 ,6FD0 ,58AE ,9CDE ,7109 ,BA29 ,6FD0 ,58AE ,9CDE ,
B30,A1,12,18,A1,29, ,A1, ,A1, ,A1, ,B1, ,B1,17,24,B1, ,B1, ,B1, ,
B29,A1,13,18,A1,25, ,A1, ,A1, ,A1, ,B1, ,B1,14,19,B1, ,B1, ,B1, ,
B28,A1,15,20,A1,23,29,A1, ,A1, ,A1, ,B1, ,B1,09,15,B1, ,B1, ,B1, ,
B27,A1,17,22,A1,23,29,A1, ,A1, ,A1, ,B1, ,B1,08,14,B1, ,B1, ,B1, ,
B26,A1,19,25,A1, ,A1, ,A1, ,A1, ,B1, ,B1,09,15,B1,28, ,B1, ,B1, ,
B25,A1,22,28,A1,22,27,A1, ,A1, ,A1, ,B1, ,B1,11,18,B1,26, ,B1, ,B1, ,
B24,A1,26, ,A1,13,19,A1, ,A1, ,A1, ,B1, ,B1,15,21,B1,27, ,B1, ,B1, ,
B23,A1, ,A1,08,14,A1, ,A1, ,A1, ,B1, ,B1,18,24,B1, ,B1, ,B1, ,
B22,A1, ,A1,05,11,A1, ,A1, ,A1, ,B1, ,B1,21,28,B1,19,24,B1, ,B1, ,
B21,A1, ,A1,05,11,A1, ,A1, ,A1, ,B1, ,B1,25, ,B1,11,17,B1, ,B1, ,
B20,A1, ,A1,06,12,A1, ,A1, ,A1, ,B1, ,B1,30, ,B1,07,13,B1, ,B1, ,
B19,A1, ,A1,08,15,A1, ,A1, ,A1, ,B1, ,B1, ,B1,05,11,B1, ,B1, ,
B18,A1, ,A1,15,22,A1, ,A1, ,A1, ,B1, ,B1, ,B1,05,10,B1, ,B1, ,
B17,A1, ,A1,22,28,A1, ,A1, ,A1, ,B1, ,B1, ,B1,05,11,B1, ,B1, ,
B16,A1, ,A1,16,23,A1, ,A1, ,A1, ,B1, ,B1, ,B1,07,13,B1, ,B1, ,
B15,A1, ,A1,13,19,A1, ,A1, ,A1, ,B1, ,B1, ,B1,13,20,B1, ,B1, ,
B14,A1, ,A1,12,19,A1, ,A1, ,A1, ,B1, ,B1, ,B1,18,23,B1, ,B1, ,<---****A1
B13,A1, ,A1,14,20,A1,24,30,A1, ,A1, ,B1, ,B1, ,B1,10,16,B1, ,B1, ,
B12,A1, ,A1,15,22,A1,22,29,A1, ,A1, ,B1, ,B1, ,B1,08,14,B1, ,B1, ,
B11,A1, ,A1,18,25,A1,26, ,A1, ,A1, ,B1, ,B1, ,B1,08,14,B1, ,B1, ,
B10,A1, ,A1,21,27,A1,26, ,A1, ,A1, ,B1, ,B1, ,B1,11,17,B1,26, ,B1, ,
B09,A1, ,A1,24, ,A1,15,21,A1, ,A1, ,B1, ,B1, ,B1,14,20,B1,25, ,B1, ,
B08,A1, ,A1,28, ,A1,09,15,A1, ,A1, ,B1, ,B1, ,B1,17,23,B1, ,B1, ,
B07,A1, ,A1, ,A1,06,11,A1, ,A1, ,B1, ,B1, ,B1,20,26,B1,27,30,B1, ,
B06,A1, ,A1, ,A1,05,11,A1, ,A1, ,B1, ,B1, ,B1,24,30,B1,16,19,B1, ,
B05,A1, ,A1, ,A1,05,11,A1, ,A1, ,B1, ,B1, ,B1,28, ,B1,10,14,B1, ,
B04,A1, ,A1, ,A1,08,14,A1, ,A1, ,B1, ,B1, ,B1, ,B1,07,11,B1, ,
B03,A1, ,A1, ,A1,12,18,A1, ,A1, ,B1, ,B1, ,B1, ,B1,06,11,B1, ,
B02,A1, ,A1, ,A1,20,26,A1, ,A1, ,B1, ,B1, ,B1, ,B1,06,10,B1, ,
B01,A1, ,A1, ,A1,18,24,A1, ,A1, ,B1, ,B1, ,B1, ,B1,09,13,B1, ,
F00,A1, ,A1, ,A1,14,21,A1, ,A1, ,B1, ,B1, ,B1, ,B1,12,17,B1, ,
F01,A1, ,A1, ,A1,13,19,A1, ,A1, ,B1, ,B1, ,B1, ,B1,20,25,B1, ,
F02,A1, ,A1, ,A1,13,19,A1,27, ,A1, ,B1, ,B1, ,B1, ,B1,16,20,B1, ,
F03,A1, ,A1, ,A1,14,21,A1,26,29,A1, ,B1, ,B1, ,B1, ,B1,11,16,B1, ,
F04,A1, ,A1, ,A1,17,24,A1,27, ,A1, ,B1, ,B1, ,B1, ,B1,11,15,B1, ,
F05,A1, ,A1, ,A1,19,26,A1, ,A1, ,B1, ,B1, ,B1, ,B1,12,16,B1,25, ,
F06,A1, ,A1, ,A1,22,29,A1,23,26,A1, ,B1, ,B1, ,B1, ,B1,15,18,B1,23,28,
F07,A1, ,A1, ,A1,26, ,A1,15,19,A1, ,B1, ,B1, ,B1, ,B1,17,22,B1,23,29,
F08,A1, ,A1, ,A1, ,A1,10,14,A1, ,B1, ,B1, ,B1, ,B1,20,25,B1, ,
F09,A1, ,A1, ,A1, ,A1,08,12,A1, ,B1, ,B1, ,B1, ,B1,24,28,B1,21,26,
F10,A1, ,A1, ,A1, ,A1,08,11,A1, ,B1, ,B1, ,B1, ,B1,27, ,B1,13,18,
trailing edge
end
```

In the results table, the tags visible to the antenna elements are numbered, and the EPC number that is unique to each tag is displayed.

Each line in the results table gives a row number followed by readings associated with RFID tags that are visible at that row. Multiple values on a line indicate that multiple tags were visible. The order of the RFID tags is arbitrary.

[Row],[Antenna Element],[Min Read Power],[Min Write Power], [Antenna Element],[Min Read Power],[Min Write Power] ...

where

- Row = the position from the leading edge of the label where calibration occurred
- Antenna Element = the antenna used (the ZD500R only has A1)
- Minimum Read Power = calibration results (0 – 30) for a tag visible from that row
- Minimum Write Power = calibration results (0 – 30) for the same tag

The read and write power values are left empty (such as A1, , ,) when no tag is found.

In the sample results table for this example, at position B25 (25 mm behind the print line), two RFID tags are visible to the printer at antenna A1. Tag 1 (EPC 7109) can be read at power level 22 and written to at power level 28. Tag 2 (EPC BA29) can be read at power level 22 and written to at power level 27. At that position, Tags 2 and 3 are visible to antenna B1 while Tag 1 is not.

```

Tag 1 ,Tag 2 ,Tag 3 ,Tag 4 ,Tag 5 ,Tag 1 ,Tag 2 ,Tag 3 ,Tag 4 ,Tag 5 ,
EPC,7109 ,BA29 ,6FD0 ,58AE ,9CDE ,7109 ,BA29 ,6FD0 ,58AE ,9CDE ,
...
B25,A1,22,28,A1,22,27,A1, , ,A1, , ,A1, , ,B1, , ,B1,11,18,B1,26, ,B1, , ,B1, , ,
B24,A1,26, ,A1,13,19,A1, , ,A1, , ,A1, , ,B1, , ,B1,15,21,B1,27, ,B1, , ,B1, , ,
B23,A1, , ,A1,08,14,A1, , ,A1, , ,A1, , ,B1, , ,B1,18,24,B1, , ,B1, , ,B1, , ,
B22,A1, , ,A1,05,11,A1, , ,A1, , ,A1, , ,B1, , ,B1,21,28,B1,19,24,B1, , ,B1, , ,
B21,A1, , ,A1,05,11,A1, , ,A1, , ,A1, , ,B1, , ,B1,25, ,B1,11,17,B1, , ,B1, , ,
...

```

At position B23, only Tag 2 is visible to antenna A1. Tag 1 is no longer visible.

```

Tag 1 ,Tag 2 ,Tag 3 ,Tag 4 ,Tag 5 ,Tag 1 ,Tag 2 ,Tag 3 ,Tag 4 ,Tag 5 ,
EPC,7109 ,BA29 ,6FD0 ,58AE ,9CDE ,7109 ,BA29 ,6FD0 ,58AE ,9CDE ,
...
B25,A1,22,28,A1,22,27,A1, , ,A1, , ,A1, , ,B1, , ,B1,11,18,B1,26, ,B1, , ,B1, , ,
B24,A1,26, ,A1,13,19,A1, , ,A1, , ,A1, , ,B1, , ,B1,15,21,B1,27, ,B1, , ,B1, , ,
B23,A1, , ,A1,08,14,A1, , ,A1, , ,A1, , ,B1, , ,B1,18,24,B1, , ,B1, , ,B1, , ,
B22,A1, , ,A1,05,11,A1, , ,A1, , ,A1, , ,B1, , ,B1,21,28,B1,19,24,B1, , ,B1, , ,
B21,A1, , ,A1,05,11,A1, , ,A1, , ,A1, , ,B1, , ,B1,25, ,B1,11,17,B1, , ,B1, , ,
...

```

At position B13, Tag 3 (EPC 6FD0) becomes visible to antenna A1 and can be read with at power level 24 and written to at power level 30.

```

Tag 1 ,Tag 2 ,Tag 3 ,Tag 4 ,Tag 5 ,Tag 1 ,Tag 2 ,Tag 3 ,Tag 4 ,Tag 5 ,
EPC,7109 ,BA29 ,6FD0 ,58AE ,9CDE ,7109 ,BA29 ,6FD0 ,58AE ,9CDE ,
...
B16,A1, , ,A1,16,23,A1, , ,A1, , ,A1, , ,B1, , ,B1, , ,B1,07,13,B1, , ,B1, , ,
B15,A1, , ,A1,13,19,A1, , ,A1, , ,A1, , ,B1, , ,B1, , ,B1,13,20,B1, , ,B1, , ,
B14,A1, , ,A1,12,19,A1, , ,A1, , ,A1, , ,B1, , ,B1, , ,B1,18,23,B1, , ,B1, , ,<---****A1
B13,A1, , ,A1,14,20,A1,24,30,A1, , ,A1, , ,B1, , ,B1, , ,B1,10,16,B1, , ,B1, , ,
...

```

The arrow (<---****) in the table indicates that a valid program position and power levels were found during calibration. The program position is identified at the top of the table as **position=B14 MM** (backfeed 14 millimeters). The optimal antenna element at that position is A1. The optimal read power is 18, and the optimal write power is 25.

```

start
position=B14 MM,A1,18,25
tid information=E200.3414:Alien
leading edge
...
B14,A1, , ,A1,12,19,A1, , ,A1, , ,A1, , ,B1, , ,B1, , ,B1,18,23,B1, , ,B1, , ,<---****A1
...

```

^RA – Read AFI or DSFID Byte



Important • This command is not supported by all printers or firmware. See [Printer and Firmware Compatibility](#) on page 380 for the list of printers and firmware with which you can use this command.

Description Use this command to read the AFI or DSFID byte. The data can be returned to the host via the ^HV command.

Format ^RA#,f,r,m,b

Parameters	Details
# = field number specified with another command	The value assigned to this parameter should be the same as the one used in the ^RT command. <i>Accepted values:</i> 0 to 9999 <i>Default value:</i> 0
f = format	<i>Accepted values:</i> 0 = ASCII 1 = Hexadecimal <i>Default value:</i> 0
r = number of retries	<i>Accepted values:</i> 0 to 10 <i>Default value:</i> 0
m = motion	<i>Accepted values:</i> 0 = Feed label after writing. 1 = No Feed after writing. Other ZPL may cause a feed. <i>Default value:</i> 0
b = type of byte to read	<i>Accepted values:</i> A = AFI byte D = DSFID byte <i>Default value:</i> A



Example 1 • This example reads the AFI byte in ASCII format and returns **AFI Byte:x** to the host. The printer will retry the command five times if necessary. A voided label is generated if the read is unsuccessful after these retries. The data read will go into the ^FN1 location of the recalled format.

```
^XA
^F020,120^A0N,60^FN1^FS
^RA1,0,5,0^FS
^HV1,,AFI Byte:^FS
^XZ
```



Example 2 • This example reads the DSFID byte in ASCII format and returns **DSFID Byte:x** to the host. The printer will retry the command three times if necessary. A voided label is generated if the read is unsuccessful after these retries. The data read will go into the ^FN1 location of the recalled format.

```
^XA
^F020,120^A0N,60^FN1^FS
^RA1,0,3,0,D^FS
^HV1,,DSFID Byte:^FS
^XZ
```

^RB – Define EPC Data Structure



Important • This command is not supported by all printers or firmware. See [Printer and Firmware Compatibility](#) on page 380 for the list of printers and firmware with which you can use this command.

Description Use this command to define the structure of EPC data, which can be read from or written to an RFID tag. For more information about EPC specifications, refer to the EPC Global web site. All parameters in this command are persistent and will be used in subsequent formats if not provided. The values are initially set to the default values.

RFID tags can have different partitions defined. This command specifies the number of partitions and how many bits are in each partition.

Format ^RBn,p0,p1,p2, . . . , p15

Parameters	Details
n = total bit size of the partitions	Specify the number of bits to include in the partitions. <i>Accepted values:</i> 1 to n, where n is the bit size of the tag. <i>Default value:</i> 96
p0 . . . p15 = partition sizes	Specify the number of bits to include in the individual partitions. The partition sizes must add up to the bit size specified for the previous parameter. The largest individual partition size is 64 bits. <i>Accepted values:</i> 1 to 64 <i>Default value:</i> 1



Example 1 • The following command specifies that there are 96 bits used with three fields. Fields 1, 2, and 3 contain 10, 26, and 60 bits, respectively.

```
^RB96,10,26,60
```

The ZPL code to encode a tag with this format would look like this:

```
^RFW,E^FD1000.67108000.1122921504606846976^FS
```

When the tag is being encoded, the tag stores the data in the following way:

- Field 1 contains **1000**. This value is stored in the first 10 bits
- Field 2 contains **67108000**. This value is stored in the next 26 bits.
- Field 3 contains **1122921504606846976**. This value is stored in the remaining 60 bits.



Example 2 • The following command specifies that there are 64 bits used with eight 8-bit fields.

```
^RB64,8,8,8,8,8,8,8,8^FS
```

The ZPL code to encode a tag with this format would look like this:

```
^RFW,E^FD1.123.160.200.249.6.1.0^FS
```

When writing to the tag, each set of data is written in its respective 8-bit field.



Example 3 • This example uses the SGTIN-96 standard, which defines 96-bit structure in the following way:

	Header	Filter Value	Partition	Company Prefix Index	Item Reference	Serial Number
SGTIN-96	8 bits	3 bits	3 bits	20–40 bits	24 bits	38 bits
	10 (binary value)	8 (decimal capacity)	8 (decimal capacity)	16,383 (decimal capacity)	9 to 1,048,575 (decimal capacity*)	33,554,431 (decimal capacity)

* Capacity of Item Reference field varies with the length of the company prefix.

The ZPL code to encode a tag with this format would look like this:

```

^XA
^RB96,8,3,3,20,24,38^FS
^RFW,E^FD48,1,6,770289,10001025,1^FS
^XZ
    
```

These commands would put

- **48** in the header
- **1** as the filter value
- **6** as the partition (indicates a 20-bit prefix and 24-bit item reference)
- **770289** as the company prefix
- **10001025** as the item reference
- **1** as the serial number

To read this EPC data and print the results on the label, you would use the following code:

```

^XA
^RB96,8,3,3,20,24,38^FS
^F050,50^A0N,40^FN0^FS
^FN0^RFR,E^FS
^XZ
    
```

The resulting label would look like this:

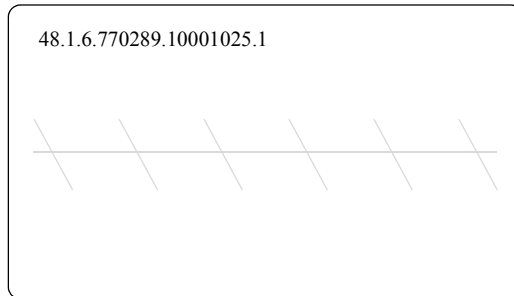

^RE – Enable/Disable E.A.S. Bit



Important • This command is not supported by all printers or firmware. See [Printer and Firmware Compatibility](#) on page 380 for the list of printers and firmware with which you can use this command.

Description Use this command to enable or disable the Electronic Article Surveillance (E.A.S.) bit that is available in some ISO15693 tags (such as Philips). This command works only on those ISO15693 transponders and will be ignored if the tag does not support E.A.S.

Format ^REt,r

Parameters	Details
t = Enable/disable the E.A.S. bit in the ISO15693 transponder	<p><i>Accepted values:</i></p> <p>N = Disable E.A.S. Y = Enable E.A.S.</p> <p><i>Default value:</i> N</p>
r = number of retries	<p><i>Accepted values:</i> 0 to 10</p> <p><i>Default value:</i> 0</p>



Example • This example enables the E.A.S. bit in the transponder. It will retry the command five times if necessary.

```
^XA
^REy,5
^XZ
```







^RF – Read or Write RFID Format

Description Use this command to read or write to (encode) an RFID tag or to specify the access password.

When using this command to read a tag, you may use a field variable to print the tag data on the label or to return the data to the host. For more information on how memory is stored on a Gen 2 tag or for examples that use a field variable, refer to the *RFID Programming Guide* for your printer. A copy of the manual is located on the User CD that came with your printer, or you can download a copy from <http://www.zebra.com/manuals>.

Format ^RFo, f, b, n, m

Parameters	Details
o = operation	<p>Specifies the action to be performed.</p> <p><i>Accepted Values:</i></p> <ul style="list-style-type: none"> W = write to (encode) the tag L = write with LOCK (if supported by tag type; Gen 2 tag type does not use this locking function) R = read the tag P = read password (Gen 2 tag type only. Not supported on all Gen 2 printers, including the ZD500R printer.) S = specify the access password <p><i>Default Value:</i> W</p>
f = format	<p><i>Accepted Values:</i></p> <ul style="list-style-type: none"> A = ASCII H = Hexadecimal E = EPC (ensure proper setup with the ^RB command) <p><i>Default Value:</i> H</p>

Parameters	Details								
<p>For Gen 2 tag type only: b = password OR b = starting block number</p> <p>For tag types other than Gen 2: b = starting block number</p>	<p>For Gen 2 tag type only: What you specify for this parameter depends on what you enter for other parameters.</p> <table border="1" data-bbox="532 394 1427 1388"> <thead> <tr> <th data-bbox="532 394 727 541">If the Operation parameter value is...</th> <th data-bbox="727 394 1427 541">Then...</th> </tr> </thead> <tbody> <tr> <td data-bbox="532 541 727 1010">W</td> <td data-bbox="727 541 1427 1010">  Note • When the memory bank parameter is set to E (EPC 96-bit) or A (EPC and Auto adjust PC bits), this value is always set to 2. <i>Accepted Values:</i> <ul style="list-style-type: none"> P, which indicates that an access password, a kill password, or both follow in a ^FD command. Each password must be 8 hex characters. If the password is omitted, it is not written. An access password is used in subsequent lock commands in the format. 0 to n, which specifies the 16-bit starting block number, where n is the maximum number of blocks for the bank specified in the memory bank parameter. <i>Default Value:</i> 0 </td> </tr> <tr> <td data-bbox="532 1010 727 1310">R</td> <td data-bbox="727 1010 1427 1310">  Note • When the memory bank parameter is set to E (EPC 96-bit) or A (EPC and Auto adjust PC bits), this value is always set to 2. <i>Accepted Values:</i> <ul style="list-style-type: none"> 0 to n, which specifies the 16-bit starting block number, where n is the maximum number of blocks for the bank specified in the memory bank parameter. <i>Default Value:</i> 0 </td> </tr> <tr> <td data-bbox="532 1310 727 1388">S</td> <td data-bbox="727 1310 1427 1388"> This parameter must be P and must be followed by the access password in a ^FD command. </td> </tr> </tbody> </table> <p>For tag types other than Gen 2: Specifies the starting block number. <i>Accepted Values:</i> 0 to n, where n is the maximum number of blocks for the tag. <i>Default Value:</i> 0</p>	If the Operation parameter value is...	Then...	W	 Note • When the memory bank parameter is set to E (EPC 96-bit) or A (EPC and Auto adjust PC bits), this value is always set to 2 . <i>Accepted Values:</i> <ul style="list-style-type: none"> P, which indicates that an access password, a kill password, or both follow in a ^FD command. Each password must be 8 hex characters. If the password is omitted, it is not written. An access password is used in subsequent lock commands in the format. 0 to n, which specifies the 16-bit starting block number, where n is the maximum number of blocks for the bank specified in the memory bank parameter. <i>Default Value:</i> 0	R	 Note • When the memory bank parameter is set to E (EPC 96-bit) or A (EPC and Auto adjust PC bits), this value is always set to 2 . <i>Accepted Values:</i> <ul style="list-style-type: none"> 0 to n, which specifies the 16-bit starting block number, where n is the maximum number of blocks for the bank specified in the memory bank parameter. <i>Default Value:</i> 0	S	This parameter must be P and must be followed by the access password in a ^FD command.
If the Operation parameter value is...	Then...								
W	 Note • When the memory bank parameter is set to E (EPC 96-bit) or A (EPC and Auto adjust PC bits), this value is always set to 2 . <i>Accepted Values:</i> <ul style="list-style-type: none"> P, which indicates that an access password, a kill password, or both follow in a ^FD command. Each password must be 8 hex characters. If the password is omitted, it is not written. An access password is used in subsequent lock commands in the format. 0 to n, which specifies the 16-bit starting block number, where n is the maximum number of blocks for the bank specified in the memory bank parameter. <i>Default Value:</i> 0								
R	 Note • When the memory bank parameter is set to E (EPC 96-bit) or A (EPC and Auto adjust PC bits), this value is always set to 2 . <i>Accepted Values:</i> <ul style="list-style-type: none"> 0 to n, which specifies the 16-bit starting block number, where n is the maximum number of blocks for the bank specified in the memory bank parameter. <i>Default Value:</i> 0								
S	This parameter must be P and must be followed by the access password in a ^FD command.								

Parameters	Details
<p><i>n</i> = number of bytes to read or write</p>	<p>Specifies the number of bytes to read or write.</p> <p>For high-frequency (HF) printers: <i>Accepted Values:</i> 1 to <i>n</i>, where <i>n</i> is the maximum number of bytes for the tag. <i>Default Value:</i> 1</p> <p>For Gen 2 tag type only: When E or A is specified for the memory bank parameter, this value is not required. <i>Accepted Values:</i> 1 to <i>n</i>, where <i>n</i> is the maximum number of bytes for the tag. <i>Default Value:</i> 1</p> <p>For all other printers and tag types: This parameter applies only when the starting block number is 1. <i>Accepted Values:</i> 1 to <i>n</i>, where <i>n</i> is the maximum number of bytes for the tag. For UCODE EPC 1.19, <i>n</i> is 32. <i>Default Value:</i> 1</p>
<p><i>m</i> = Gen 2 memory bank</p>	<p> Note • This parameter applies to Gen 2 tags only.</p> <p>Specifies the Gen 2 memory bank. For more information about Gen 2 memory, refer to the <i>RFID Programming Guide</i> for your printer.</p> <p><i>Accepted Values:</i></p> <ul style="list-style-type: none"> E = EPC 96-bit (When writing data, this parameter performs the operation on Gen 2 bit address 20_h and accesses 12 bytes of the EPC memory bank. When reading data, this parameter reads the amount of data specified in the PC bits on the tag.) A = EPC and Auto adjust PC bits (When writing data, this parameter performs the operation on Gen 2 bit address 20_h of the EPC memory bank and accesses the number of bytes specified in the ^FD. The PC bits will be updated to match the amount of data written to the tag. When reading data, this parameter reads the amount of data specified in the PC bits on the tag.) NOTE: This value is supported only by the ZD500R™ printer and ZT400™ Series RFID printers. 0 = Reserved 1 = EPC 2 = TID (Tag ID) 3 = User <p><i>Default Value:</i> E</p>



Example 1 • This example encodes 96-bit data in ASCII format. (The ^RS command can be omitted for printers that use Gen 2 tag types only.)

```
^XA
^RS8
^RFW,A^FD00 my data^FS
^XZ
```

→ **Example 2** • This example encodes 96-bit EPC data, as specified by the **^RB** command.

```
^XA
^RB96,8,3,3,3,20,24,38
^RFW,E^FD16,3,5,78742,146165,1234567891^FS
^XZ
```

→ **Example 3** • This example encodes 4 bytes of hexadecimal formatted data, starting in block 3 of Gen 2 EPC bank 1. (The **^RS** command can be omitted for printers that use Gen 2 tag types only.)

```
^XA
^RS8
^RFW,H,3,4,1^FD11112222^FS
^XZ
```

→ **Example 4** • This example reads the extended Gen 2 tag ID (TID), which is not read by the **^RI** command, and returns the results to the host computer. The results are labeled with the header “8-byte Tag ID Data.” (The **^RS** command can be omitted for printers that use Gen 2 tag types only.)

```
^XA
^RS8
^RFR,H,0,8,2^FN1^FS^HV1,,8-byte Tag ID Data:^FS
^XZ
```

→ **Example 5** • This command writes and specifies both the access password (12345678) and the kill password (88887777) separated by a comma.

```
^RFW,H,P^FD12345678,88887777^FS
```

This command writes the access password only:

```
^RFW,H,P^FD12345678^FS
```

This command writes the kill password only (a comma must be used before it to distinguish it from an access password):

```
^RFW,H,P^FD,88887777^FS
```

See the examples for [^RL on page 403](#) for how this command would be used in a format.

→ **Example 6** • This command writes 1122334455667788 to the bit address 20h of the EPC memory and updates the PC bits bit address 10h to 14h to reflect 8 bytes (4 words) of data.

```
^RFW,H,,A^FD1122334455667788^FS
```

→ **Example 7** • This command specifies the access password for the tag, which will be used in subsequent lock commands in the format. The access password specified must match the one stored on the tag. This command does not write the password to the tag. See the examples for [^RL on page 403](#) for how this command would be used in a format.

```
^RFS,H,P^FD12345678^FS
```

^RI – Get RFID Tag ID



Important • This command is not supported by all printers or firmware. See [Printer and Firmware Compatibility on page 380](#) for the list of printers and firmware with which you can use this command.

Description Use this command to get the unique serial number of the tag and return it in hexadecimal format. The data can be sent back to the host via the ^HV command.

For Gen 2 tag types, this command returns the 32-bit tag ID (TID) for the tag. If your Gen 2 tag supports TID data beyond 32 bits, see [^RF on page 398](#) to access the TID memory bank.

Format ^RIa,b,c,d

Parameters	Details
a = number to be assigned to the field	Accepted values: 0 to 9999 Default value: 0
b = specify data order	 Note • This parameter applies only to the R110Xi HF and R2844-Z printers. Accepted Values: 0 = Most significant byte first for Tag*It and PicoTag. Least significant byte first for I*code and ISO15693. 1 = Reverse the data order Default value: 0
c = number of retries	Accepted values: 0 to 10 Default value: 0
d = motion	Accepted values: 0 = Feed label after writing 1 = No Feed after writing (other ZPL commands may cause a feed) Default value: 0



Example • This example reads a tag ID, prints it on a label, and sends string Tag ID:xxxxxxx to the host. The data read will go into the ^FN0 location of the format. The printer will retry the command five times, if necessary.

```

^XA
^F020,120^A0N,60^FN0^FS
^RI0,,5^FS
^HV0,,Tag ID:^FS
^XZ
    
```

^RL – Lock/Unlock RFID Tag Memory

The ^RL command has two distinct formats and functions:

- **^RLM – Lock/Unlock the Specified Memory Bank**
Locks a password or an entire memory bank in a writeable or unwriteable state. These locks/unlocks can be permanent or reversible.
- **^RLB – Permanently Lock Specified Memory Sections**
Locks blocks of user memory in an unwriteable state.

^RLM – Lock/Unlock the Specified Memory Bank

Description The ^RLM command locks/unlocks the specified password or memory bank on an RFID tag. You can use this command to do the following:

- lock individual passwords, thereby preventing or allowing subsequent reads or writes of that password
- lock individual memory banks, thereby preventing or allowing subsequent writes to those banks
- Permanently lock (permalock) the lock status for a password or memory bank

Format ^RLM,k,a,e,u

Parameters	Details
k = kill password function	<p><i>Accepted Values:</i></p> <ul style="list-style-type: none"> U = unlock the kill password* L = lock the kill password* O = permanently unlock (Open) the kill password P = permanently lock (Protected) the kill password
a = access password function	<p><i>Accepted Values:</i></p> <ul style="list-style-type: none"> U = unlock the access password* L = lock the access password* O = permanently unlock (Open) the access password P = permanently lock (Protected) the access password
e = EPC memory bank function	<p><i>Accepted Values:</i></p> <ul style="list-style-type: none"> U = unlock the EPC memory bank* L = lock the EPC memory bank* O = permanently unlock (Open) the EPC memory bank P = permanently lock (Protected) the EPC memory bank
u = USER memory bank function	<p><i>Accepted Values:</i></p> <ul style="list-style-type: none"> U = unlock the USER memory bank* L = lock the USER password bank* O = permanently unlock (Open) the USER memory bank P = permanently lock (Protected) the USER memory bank

* The access password must be set to something other than the default of 00000000 to use this value. See [Example 4 on page 404](#) for an example.

^RLB – Permanently Lock Specified Memory Sections

Description The ^RLB command permanently locks (permalocks) one or more sections (individual sub-portions) in a tag’s user memory. The section sizes for each tag is defined by the tag manufacturer.

Format ^RLB,s,n

Parameters	Details
s = starting section	Specify the starting section of memory to lock.
n = number of sections	Specify the number of sections to lock.

➔ **Example 1** • The following command locks all memory banks using a previously specified access password.

```
^RLM,L,L,L,L^FS
```

➔ **Example 2** • The following command locks the user memory banks using a previously specified access password.

```
^RLM,,,L^FS
```

➔ **Example 3** • The following command permalocks sections 0 to 4 of user memory using a previously specified access password.

```
^RLB,0,4^FS
```

➔ **Example 4** • This code does the following:

- writes 12 bytes to user memory
- writes “12345678” to the access password and “11223344” to the kill password
- permalocks 6 sections of user memory using “12345678” as the access password
- locks the kill and access passwords and permanently unlocks the EPC memory, using “12345678” as the access password

```
^XA
^RFW,H,0,12,3^FD112233445566778899001122^FS
^RFW,H,P^FD12345678,11223344^FS
^RLB,0,6^FS
^RLM,L,L,0^FS
^XZ
```

➔ **Example 5** • This code does the following:

- writes 12 bytes to user memory
- permalocks 6 sections of user memory using “00000000” as the access password
- permalocks the kill password and access password using “00000000” as the access password

```
^XA
^RFW,H,0,12,3^FD112233445566778899001122^FS
^RLB,0,6^FS
^RLM,P,P^FS
^XZ
```

^RM – Enable RFID Motion



Important • This command is not supported by all printers or firmware. See [Printer and Firmware Compatibility](#) on page 380 for the list of printers and firmware with which you can use this command.

Description Use this command to enable or disable RFID motion. By default, labels automatically print at the end of the format. This command allows you to inhibit the label from actually moving when it reaches the program position, which is useful for debugging, setup, and custom applications. This parameter is not persistent (carried over from label to label).

Format ^RMe

Parameters	Details
e = enable	<i>Accepted values:</i> Y = Yes, move the label N = No, do not move the label <i>Default value:</i> Y

^RN – Detect Multiple RFID Tags in Encoding Field



Important • This command is not supported by all printers or firmware. See [Printer and Firmware Compatibility](#) on page 380 for the list of printers and firmware with which you can use this command.

Description Use this command to enable or disable detection of multiple RFID tags in the encoding field. By default, the printer checks for more than one tag in the field before attempting to read or write. If more than one tag is found, the label over the antenna support is voided, and the **RFID ERR STATUS** parameter on the control panel displays **MULTIPLE TAGS**. To speed up printing and encoding by up to 200 ms, the check may be disabled.



Note • This parameter is persistent across labels (carried over from label to label), but is NOT persistent across power cycles.

Format ^RNe

Parameters	Details
e = enable	<p><i>Accepted Values:</i></p> <ul style="list-style-type: none"> Y = Yes, check for multiple tags N = No, do not check for multiple tags <p><i>Default Value:</i></p> <ul style="list-style-type: none"> Y = Printers with firmware R60.13.0.5 and earlier N = Printers with firmware R60.13.0.7 and later <p> Note • If an invalid parameter value is entered, the default value will be used.</p>

^RQ – Quick Write EPC Data and Passwords



Important • This command is not supported by all RFID tags, printers, or firmware. See *Printer and Firmware Compatibility* on page 380 for the list of printers and firmware with which you can use this command.

Description Use this command with an Alien Higgs RFID tag and appropriate firmware to write the EPC data, access password, and kill password with one command. Doing so reduces the encoding time.



Note • The access password on the tag to be written to must be 00000000 prior to sending this command.

Format ^RQf,c,o[data]

Parameters	Details
f = format	<p><i>Accepted Values:</i></p> <ul style="list-style-type: none"> A = ASCII H = Hexadecimal E = EPC <p><i>Default Value:</i> H</p>
c = chip type	<p><i>Accepted Values:</i> 0 (Higgs IC tag)</p> <p><i>Default Value:</i> 0</p>
o = option	<p><i>Accepted Values:</i> 0 (write 96-bit EPC)</p> <p><i>Default Value:</i> 0</p>
data = the EPC data, access password, and kill password	<p>Use the ^FD command to specify the passwords in the following format:</p> <p style="text-align: center;">^FD[EPC],[access],[kill]</p> <p>where:</p> <ul style="list-style-type: none"> EPC = the EPC data in the format specified by the f parameter. The data should match what would be programmed with the ^RF command. access = an optional access password in hexadecimal format. If this field is left blank, 0x00000000 is written as the access password. kill = an optional kill password in hexadecimal format. If this field is left blank, 0x00000000 is written as the kill password.



Example 1 • This example writes the EPC data to the tag in hexadecimal format. The unspecified access and kill passwords are written as zeroes (0x00000000).

```
^XA^RQ^FD112233445566778899001122^XZ
```



Example 2 • This example writes the EPC data to the tag in hexadecimal format. The access password is written as 0xAAAAAAAA, and the kill password is written as 0xBBBBBBBB.

```
^XA^RQ^FD112233445566778899001122,AAAAAAAA,BBBBBBBB^XZ
```



Example 3 • This example writes the EPC data to the tag in EPC format. The unspecified access and kill passwords are written as zeroes (0x00000000).

```
^XA^RB96,30,30,30,6^RQE^FD1234.5678.9012.12^XZ
```



Example 4 • This example writes the EPC data to the tag in hexadecimal format. The access password is written as 0xAAAAAAAA, and the unspecified kill password is written as zeroes (0x00000000).

```
^XA^RB96,30,30,30,6^RQE^FD1234.5678.9012.12,AAAAAAAA^XZ
```

^RR – Specify RFID Retries for a Block or Enable Adaptive Antenna Selection



Important • This command is not supported by all printers or firmware. See [Printer and Firmware Compatibility on page 380](#) for the list of printers and firmware with which you can use this command.

Description Use this command for the following:



- to change the number of times that the printer attempts to read or write to a particular block of a single RFID tag (Not applicable to printers with firmware V75.19.7Z or later.)
- to enable the adaptive antenna element selection feature

This command is persistent and will be used in subsequent formats if not provided.



Note • This command's function is different than the “number of labels” parameter in the ^RS command.

Format ^RRn,a

Parameters	Details
n = number of retries	 Note • This parameter does not apply to the ZT400 printer. <i>Accepted Values: 0 to 10</i> <i>Default Value: 6</i>
a = adaptive antenna element selection	 Note • This parameter is valid only on R110Xi4 and ZT400 printers with a label that is 2 in. (51 mm) or longer. If the printer cannot find RFID tags with the antenna element specified during the number of retries specified (if applicable), the printer may try neighboring antenna elements. If the printer is unsuccessful communicating with the RFID tag after trying the neighboring antenna elements, the printer voids the label.  Note • Activating this parameter may slow throughput on damaged or weak RFID tags. <i>Accepted Values: 0 or 1</i> 0 = None. The printer uses only the current antenna element selection. 1 = Neighbors. The printer attempts to read the tag using the antenna elements to the left/right and above/below the current antenna element. The antenna element that is successful is used for all subsequent RFID commands until the next unsuccessful attempt. <i>Default Value: 0</i>



Example 1 • This example sets the read block retries to 5.

```
^XA  
^FN1^RR5^RFR,H^FS  
^HV1^FS  
^XZ
```



Example 2 • This example sets the write block retries to 2.

```
^XA  
^RR2^RFW,H^FD1234^FS  
^XZ
```



Example 3 • On an R110Xi4 printer, this example sets the write retries to 2 and allows the printer to try neighboring antennas in the event that the current antenna cannot write to the RFID tag.

```
^XA  
^RR2,1^RFW,H^FD1234^FS  
^XZ
```

^RS – Set Up RFID Parameters

Use this command to set up RFID parameters including tag type; programming position; and error handling. In addition to reading or encoding RFID tags, the RFID ZPL commands also provide for RFID exception handling, such as setting the number of read/write retries before declaring a transponder defective (set with ^RR, ^RT, and ^WT) or setting the number of labels that will be attempted if an error occurs (set with ^RS).

For example, if an RFID label fails to program correctly or if the transponder cannot be detected, the printer ejects the label and prints **VOID** across it. The printer will try to print another label with the same data and format for the number of labels specified (parameter *n*). If the problem persists, the printer follows the error handling instructions specified by the error handling parameter (parameter *e*): the printer may remove the problematic format from the print queue and proceed with the next format (if one exists in the buffer), or it may place the printer in Pause or Error mode.







Use care when using this command in combination with ^RT or ^RF for reading tag data. Problems can occur if the data read from the tag is going to be printed on the label. Any data read from the tag must be positioned to be printed above the read/write position. Failure to do this will prevent read data from being printed on the label.

Format ^RSt,p,v,n,e,a,c,s

Parameters	Details
<p>t = tag type</p>	<p>Tells the printer/print engine which tag type you are using. If you specify a tag type that is not supported by your printer or firmware, the printer uses its default value. For the supported tag types and defaults, see Table 7 on page 87.</p> <p><i>Accepted Values:</i></p> <p>UHF Printers</p> <ul style="list-style-type: none"> 0 = None 1 = EPC Class 0 2 = EPC Class 0 Plus 3 = EPC Class 1 64-bit 4 = EPC Class 1 96-bit 5 = UCODE EPC 1.19 6 = Impinj Class 0 Plus 7 = ISO 18000-06A 8 = EPC Class 1, Generation 2 (Gen 2) 9 = ISO 18000-06B <p>HF Printers</p> <p> Note • Only the R110Xi HF printer (firmware version R65.X.X) supports the use of letters for this parameter. All other printers use the numbers.</p> <ul style="list-style-type: none"> A or 0 = None B or 1 = Auto detect (query tag to determine) C or 2 = Tag*It (Texas Instruments Tagit tags) D or 3 = I*code (Phillips Icode tags) E or 4 = Pico Tag (Inside Technology's) F or 5 = ISO 15693 G or 6 = EPC tag (13.56 MHz) H or 7 = UID Tag I or 8 = Mifare UltraLight <p><i>Default Value:</i> varies by printer (see Table 7 on page 87)</p>

Parameters	Details
<p>p = read/write position of the tag (programming position)</p>	<p>This parameter sets the read/write position of the tag.</p> <p> Important • If a label format specifies a value for the programming position, this value will be used for the programming position for all labels until a new position is specified or until the tag calibration procedure is run.</p> <p><i>Accepted Values:</i></p> <p>For the ZD500R only:</p> <p>F0 to Fxxx (where xxx is the label length in millimeters or 999, whichever is less) The printer prints the first part of a label until it reaches the specified distance and then begins programming. After programming, the printer prints the remainder of the label.</p> <p>B0 to B30 The printer backfeeds the label for the specified distance and then begins programming. To account for the backfeed, allow empty media liner to extend out of the front of the printer when using a backward programming position.</p> <p>up = move to the next value down = move to the previous value</p> <p>For other RFID printers:</p> <p><i>Absolute Mode</i> (all firmware versions): xxxx = 0 to label length (in dot rows). Move the media to the specified position xxxx on the label, measured in dot rows from the label top, before encoding. Set to 0 (no movement) if the tag is already in the effective area without moving the media.</p> <p><i>Relative Mode</i> (firmware versions V53.17.6 and later): F0 to Fxxx (where xxx is the label length in millimeters or 999, whichever is less) The printer prints the first part of a label until it reaches the specified distance and then begins programming. After programming, the printer prints the remainder of the label.</p> <p>B0 to B30 (Does not apply to the RP4T printer.) The printer backfeeds the label for the specified distance and then begins programming. To account for the backfeed, allow empty media liner to extend out of the front of the printer when using a backward programming position.</p> <p><i>Default value:</i></p> <p>For the R2844-Z and RPAX: 0 (no movement) For printers using V53.17.6, V74.19.6Z, and later: F0 (which moves the leading edge of the label to the print line) For all other printers or firmware: label length minus 1 mm (1/16 in.)</p>
<p>v = length of void printout</p>	<p>Sets the length of the void printout in vertical (Y axis) dot rows.</p> <p><i>Accepted values:</i> 0 to label length</p> <p><i>Default value:</i> label length</p>

Parameters	Details
n = number of labels to try encoding	<p>The number of labels that will be attempted in case of read/encode failure.</p> <p><i>Accepted values: 1 to 10</i></p> <p><i>Default value: 3</i></p>
e = error handling	<p>If an error persists after the specified number of labels are tried, perform this error handling action.</p> <p><i>Accepted values:</i></p> <ul style="list-style-type: none"> N = No action (printer drops the label format causing the error and moves to the next queued label) P = Place printer in Pause mode (label format stays in the queue until the user cancels) E = Place printer in Error mode (label format stays in the queue until the user cancels) <p><i>Default value: N</i></p> <p> Note • You can set the printer to send an error message to the host for each failure. To enable or disable this unsolicited error message, refer to the ^SX and ^SQ ZPL commands. Use V for the condition type for an RFID error.</p>
a = signals on applicator	<p> Note • This parameter does not apply to the R2844-Z. For the R4Mplus, this parameter applies only to printers with firmware version SP994X (R4Mplus European version).</p> <p>Single Signal Mode</p> <p>In this mode, one start print signal starts printing. Then, at the program position (parameter p), the printer automatically stops and encodes the tag. Printing continues, and a single end print signal signifies the completion of the label.</p> <p>Double Signal Mode</p> <p>With RFID, when there is a non-zero program position, the label is logically split into two parts. The first part is printed, the tag encodes, and then the second part prints. If this parameter is set to “D,” then the label is split into two and requires both portions of the label to be controlled by the applicator. This means that a start print signal triggers the first portion of the label, and then when the printer reaches the RFID program position (and the motor stops), an end print signal is provided. In this mode, a second start print signal is required to print the rest of the label. When the label is complete, a final end print signal is provided.</p> <p> Note • If parameter p is zero, then single signal mode is used (parameter ignored). If p is F0 (or B0) with backfeed-after, then single signal mode is used (parameter ignored).</p> <p><i>Accepted values:</i></p> <ul style="list-style-type: none"> S = single signal D = double signal (For the R110PAX4, Double mode will work only if the read/write position is changed from the default of zero.) <p><i>Default value: S</i></p>
c = reserved	Not applicable.

Parameters	Details
s = void print speed	 Note • This parameter does not apply to the R2844-Z printer. For the R4Mplus printer, this parameter applies only to printers with firmware version SP994X (R4Mplus European version). If a label is voided, the speed at which “VOID” will be printed across the label. <i>Accepted values:</i> any valid print speed <i>Default value:</i> the printer’s maximum print speed

Supported Tag Types Table 22 shows the tag types supported by different RFID printers/print engines and firmware versions. Depending on your country or on the firmware version that you are using, your printer may not support all of the tag types listed. If you specify an unsupported tag type, the printer uses the default value. If a tag type is shown as supported but does not work with your printer, you may need to upgrade the printer’s firmware (see <http://www.zebra.com/firmware>).

Table 22 • Supported Tag Types and Default Values

Printer	UHF Printers											HF Printers				
	ZD500R	R110Xi4	R110Xi/ R170Xi	R110PAX4				R4Mplus				RZ400/ RZ600	R110Xi HF	R2844-Z		
Firmware Version	V74.19.6Z and later	V53.17.7 and later	R60.13.X	R60.15.X and later	R62.13.X	R62.15.X and later	R63.13.X	R63.15.X and later	SP994O, SP999E, SP1027E, SP1082E, and earlier	SP994F, SP999F, SP1027F, SP1082F, and later	SP1056D and earlier	SP1056E and later	R53.16.X and later	R65.13.X	R65.15.X and later	all
Tag Type																
UHF Tag Types and Options																
None (no tag type specified)	—	—	*	*	*	*	—	—	—	—	—	—	—	—	—	—
EPC Class 0	—	—	*	*	*	*	—	—	—	—	—	—	—	—	—	—
EPC Class 0 Plus	—	—	*	*	*	*	—	—	—	—	—	—	—	—	—	—
EPC Class 1 64-bit	—	—	*	*	*	*	—	—	—	—	—	—	—	—	—	—
EPC Class 1 96-bit	—	—	#	*	#	*	—	*	*	*	—	—	—	—	—	—
UCODE EPC 1.19	—	—	* a	*	—	*	#	*	#	*	#	*	—	—	—	—
Impinj Class 0 Plus	—	—	*	*	*	*	—	—	—	—	—	—	—	—	—	—
ISO 18000-06A	—	—	—	—	*	—	—	*	*	*	—	—	—	—	—	—
EPC Class 1, Generation 2 (Gen 2)	#	#	*	#	*	#	—	#	*	#	*	#	#	—	—	—
ISO 18000-06B	—	—	*	*	*	*	—	*	*	*	*	*	—	—	—	—

= Default value * = Accepted value — = Not supported
 a. Requires R60.13.0.13ZD or later.

Table 22 • Supported Tag Types and Default Values (Continued)

Printer	UHF Printers												HF Printers			
	ZD500R	R110Xi4	R110Xi/ R170Xi	R110PAX4				R4Mplus				RZ400/RZ600	R110Xi/HF	R2844-Z		
Firmware Version	V74.19.6Z and later	V53.17.7 and later	R60.13.X	R60.15.X and later	R62.13.X	R62.15.X and later	R63.13.X	R63.15.X and later	SP994O, SP999E, SP1027E, SP1082E, and earlier	SP994P, SP999F, SP1027F, SP1082F, and later	SP1056D and earlier	SP1056E and later	R53.16.X and later	R65.13.X	R65.15.X and later	all
Tag Type																
HF Tag Types and Options																
Auto-detect the tag type by querying the tag	—	—	—	—	—	—	—	—	—	—	—	—	—	—	—	#
Tag*It (Texas Instruments Tagit tags)	—	—	—	—	—	—	—	—	—	—	—	—	—	—	—	*
I*code (Phillips Icode tags)	—	—	—	—	—	—	—	—	—	—	—	—	—	—	—	*
Pico Tag (Inside Technology's)	—	—	—	—	—	—	—	—	—	—	—	—	—	—	—	*
ISO 15693	—	—	—	—	—	—	—	—	—	—	—	—	—	#	#	*
EPC tag	—	—	—	—	—	—	—	—	—	—	—	—	—	—	—	*
UID Tag	—	—	—	—	—	—	—	—	—	—	—	—	—	—	—	—
Mifare UltraLight	—	—	—	—	—	—	—	—	—	—	—	—	—	*	*	—

= Default value * = Accepted value — = Not supported

a. Requires R60.13.0.13ZD or later.



Example 1 • The following are examples of Absolute Mode and Relative Mode for the tag position parameter (parameter **p**).

Absolute Mode

1. ^RS,520 sets the encode position at 520 dots from the top edge of the label.
2. ^RS,0 programs the tag without moving the media.

Relative Mode

1. ^RS,F1 sets the encode position 1 mm forward from the leading edge of the label.
2. ^RS,B10 sets the encode position 10 mm backwards from the leading edge of the label.
3. ^RS,F0 sets the encode position at the leading edge of the label.
4. ^RS,B0 sets the encode position at the leading edge of the label.



Example 2 • The following shows the difference between absolute and relative programming positions for the tag position parameter (parameter **p**) with a 6-inch (152-mm, 1216-dot) label length. The end results are that the tag is programmed with the label in the same position.

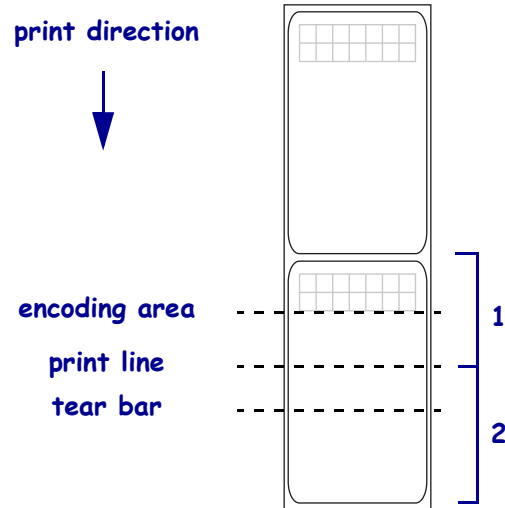

1	^RS,496, Absolute Mode, 496 dots from the top of the label
2	^RS, F90, Relative Mode, 90 mm from the leading edge of the label

^RT – Read RFID Tag



Note • The ^RT command is provided only for backward-compatibility with label formats that were developed for older Zebra RFID printers. See [Printer and Firmware Compatibility on page 380](#) for the list of printers and firmware with which you should not use this command.

Description Use this command to tell the printer to read the current RFID tag data. The data can be returned to the host via the ^HV command.

Format ^RT#,b,n,f,r,m,s

Parameters	Details
# = number to be assigned to the field	Accepted values: 0 to 9999 Default value: 0
b = starting block number	Accepted values: 0 to n, where n is the maximum number of blocks for the tag. Default value: 0
n = number of blocks/bytes to read	Accepted values: 1 to n, where n is the maximum number of blocks for the tag type minus the starting block number. For example, if the tag has 8 blocks (starting with block 0) and you start with block 6, n can be 2. This would return block 6 and block 7 information. Default value: 1
f = format	Accepted values: 0 = ASCII 1 = Hexadecimal Default value: 0
r = number of retries	Changes the number of times that the printer attempts to read a particular block of a single RFID tag. (Same retry rules as the ^RR command.) Accepted values: 0 to 10 Default value: 0
m = motion	Enables or disables RFID motion for the current field. Accepted values: 0 = Feed label after writing. 1 = No feed after writing. Other ZPL may cause a feed. Default value: 0

Parameters	Details
s = special mode	 Note • This parameter is used only for the printers referenced here. For R4Mplus printers with firmware version SP920X (U.S. version): Specify actions for mismatched checksums. For EPC Class 1 (Alien reader) only. Not applicable for EPC class 0. <i>Default value:</i> 0 <i>Accepted values:</i> 0 = Do not read if mismatched checksum 1 = Read even if mismatched checksum For R110Xi HF and R2844-Z printers: Specify data order. <i>Default value:</i> 0 <i>Accepted values:</i> 0 = least significant byte first 1 = most significant byte first



Example 1 • This example reads a tag, prints the data on a label, and sends the string **Tag Data:xxxxxxxx** back to the host. The data read will go into the ^FN1 location of the format. The printer will retry the command five times, if necessary.

```
^XA
^F020,120^A0N,60^FN1^FS
^RT1,,5^FS
^HV1,,Tag Data:^FS
^XZ
```



Example 2 • This example reads from a tag twice and prints the results on a label.

```
^XA
^F020,120^A0N,60^FN1^FS
^F020,100^A0N,20^FN2^FS
^RT1,7,3,,5^FS
^RT2,3,2,,5^FS
^XZ
```

The first ^RT command starts at block 7 and reads three blocks of data in ASCII format. The data read will go into the ^FN1 location of the format. The printer will retry the command five times, if necessary.

The second ^RT command starts at block 2 and reads two blocks of data in ASCII format. The data read will go into the ^FN2 location of the format. The printer will retry the command five times, if necessary.

^RU – Read Unique RFID Chip Serialization

Use this command to read the TID (Tag ID) data from the current chip and format a unique 38-bit serial number, which will be placed in the lower (least significant) 38 bits of the EPC code.

Format ^RUa,b

Parameters	Details
a = prefix	<p>Specifies the prefix in ASCII Binary</p> <p><i>Accepted Values:</i> Only ASCII characters 1 and 0 are accepted. Maximum of 38 characters.</p> <p>The number of bits in the value specifies the length of the prefix. The prefix is placed as the left-most (most significant) bits in the unique serial number.</p> <p>If nothing is specified, the default value will be used.</p> <p><i>Default Value:</i> The MCS prefix is determined by the MDID in the TID of the chip read:</p> <ul style="list-style-type: none"> • 100 = EM Micro • Impinj = 101 • Alien = 110 • NXP = 111
b = special character	<p>Special character for serial number inclusion.</p> <p><i>Accepted Values:</i> Any ASCII character other than the current Command character, Control character, Delimiter character, or any of the Real-Time Clock (RTC) characters.</p> <p><i>Default Value:</i> #</p>



Note • Serial number inclusion:

One of several data elements can be included into any ^FD data string in the same way that Real Time Clock data is included. Use any of the commands below to include a data pattern based on the serial number. These are defined using the default value for the Special Character.

#S = include 38-bit serial number derived from TID in decimal form.

#H = include 38-bit serial number derived from TID in hexadecimal form.

#E = include the entire 96-bit EPC code, including the 38-bit serial number derived from TID in decimal form.

#F = include the entire 96-bit EPC code, including the 38-bit serial number derived from TID in hexadecimal form.

#P = include the entire 96-bit EPC code, but use the tag's preprogrammed, 38-bit SGTIN serial number in decimal form.*

#Q = include the entire 96-bit EPC code, but use the tag's preprogrammed, 38-bit SGTIN serial number in hexadecimal form.*

* If the EPC has been preprogrammed (typically by the manufacturer) with the chip-based RFID serialization scheme, then the serialized data does not have to be written back to the EPC memory, which saves time. **#P** and **#Q** simply format the data that is read from the EPC memory bank.

→ **Example 1** • Read the TID from the tag, create a serial number based on the tag type, write 12<serial number (5 bytes)>000000000000 to the 96-bit EPC field, and print the serial number (in hex format) on the label.

```
^XA
^RU
^F010,10^A0N,50,50^FDSerial Number: #H^FS
^RFW,H^FD12#H^FS
^XZ
```

→ **Example 2** • Read the TID from the tag, create a serial number based on the tag type, write the serial number to the EPC field (lower 38 bits) while maintaining the contents of the rest of the EPC memory, print **Serial Number: <serial number in hex format>** on the label, and return **Serial Number: <serial number in hex format>** to the host. Perform this operation on three label formats.

```
^XA
^RU
^F010,10^A0N,50,50^FN1^FS
^FN1^FDSerial Number: #H^FS
^FH^HV1,24, ,_0D_0A,L^FS
^RFW,H^FD#F^FS
^PQ3
^XZ
```

→ **Example 3** • Read the full EPC (already serialized) from the tag, print **Serial Number: <full EPC in decimal format>** on the label, and return **Serial Number: <full EPC in decimal format>** to the host.

```
^XA
^RU
^F010,10^A0N,50,50^FN1^FS
^FN1^FDSerial Number: #P^FS
^FH^HV1,44, ,_0D_0A,L^FS
^XZ
```

~RV – Report RFID Encoding Results



Important • This command is not supported by all printers or firmware. See [Printer and Firmware Compatibility](#) on page 380 for the list of printers and firmware with which you can use this command.

Description Use this command to tell the printer to send RFID encoding success or failure results to the host computer after each label format completes.

Format ~RVa

Parameters	Details
a = enable/disable	Enables or disables the results reporting feature. <i>Accepted Values:</i> E = Enable D = Disable <i>Default Value:</i> D



Example 1 • Assume that the following code is sent and that there is no RFID tag in the field.

```
~RVE
^XA
^RS8,0,,3
^RMY
^RFR,H
^XZ
```

The printer attempts to program a tag three times and then returns the following to the host:

```
_-,3_
```

The minus sign indicates that the programming attempt failed entirely and voided three labels.



Example 2 • Assume that the same code is sent and that the first two attempts at programming a tag are unsuccessful. The third attempt succeeds.

```
~RVE
^XA
^RS8,0,,3
^RMY
^RFR,H
^XZ
```

The printer attempts to program a tag three times and then returns the following to the host:

```
_+,2_
```

The plus sign indicates that the programming attempt was successful and voided two labels.

^RW – Set RF Power Levels for Read and Write



Important • This command is not supported by all printers or firmware. See [Printer and Firmware Compatibility](#) on page 380 for the list of printers and firmware with which you can use this command.

Description Use this command to set the RFID read and write power levels if the desired levels are not achieved through RFID tag calibration. If not enough power is applied, the tag may not have sufficient power for programming, and tag data will fail to encode. If too much power is applied, the extra power may cause data communication errors or may cause the wrong tag to be programmed.



Note • For the R110Xi4, ZT400, and ZD500R printers:

During RFID tag calibration, the printer automatically selects the best read/write power levels and the best antenna element (not applicable to the ZD500R) for the media being used. The R110Xi4 printer may also set the levels during an adaptive antenna sweep. Use the `~HL` command (see [^HL or ~HL](#) on page 385) to view the antenna element and power settings being used.



Note • For the R110Xi4, ZT400, and ZD500R printers:

During RFID tag calibration, the printer automatically selects the best read/write power levels and the best antenna element (not applicable to the ZD500R) for the media being used. The R110Xi4 printer may also set the levels during an adaptive antenna sweep. Use the `~HL` command (see [^HL or ~HL](#) on page 385) to view the antenna element and power settings being used.

Format ^RW*r*,*w*,*a*

Parameters	Details
<code>r</code> = read power	<p>This parameter sets the power level to match the desired output as calibrated in the factory.</p> <p>R53.16.3, V53.17.5, and later: <i>Values:</i> 0 to 30 <i>Default Value:</i> 16</p> <p>R60.16.4, R62.16.4, R63.16.4, SP994Q, SP999G, SP1027G, SP1056F, SP1082G, and later: <i>Values:</i> 0 to 30, H (high), M (medium), L (low) <i>Default Value:</i> L</p> <p>R65.X and older versions of other firmware: <i>Accepted Values:</i> H = high M = medium L = low <i>Default Value:</i> L</p>

Parameters	Details
<p>w = write power</p>	<p> Note • This parameter is ignored on the R110Xi HF printer (firmware version R65.X) because read and write powers cannot be specified separately. The printer uses the value that you specified for read power for both the read and write power settings.</p> <p>This parameter sets the power level to match the desired output as calibrated in the factory.</p> <p>R53.16.3, V53.17.5, and later: <i>Values:</i> 0 to 30 <i>Default Value:</i> 16</p> <p>R60.16.4, R62.16.4, R63.16.4, SP994Q, SP999G, SP1027G, SP1056F, SP1082G, and later: <i>Values:</i> 0 to 30, H (high), M (medium), L (low) <i>Default Value:</i> L</p> <p>Older versions of firmware: <i>Accepted Values:</i> H = high M = medium L = low <i>Default Value:</i> L</p>

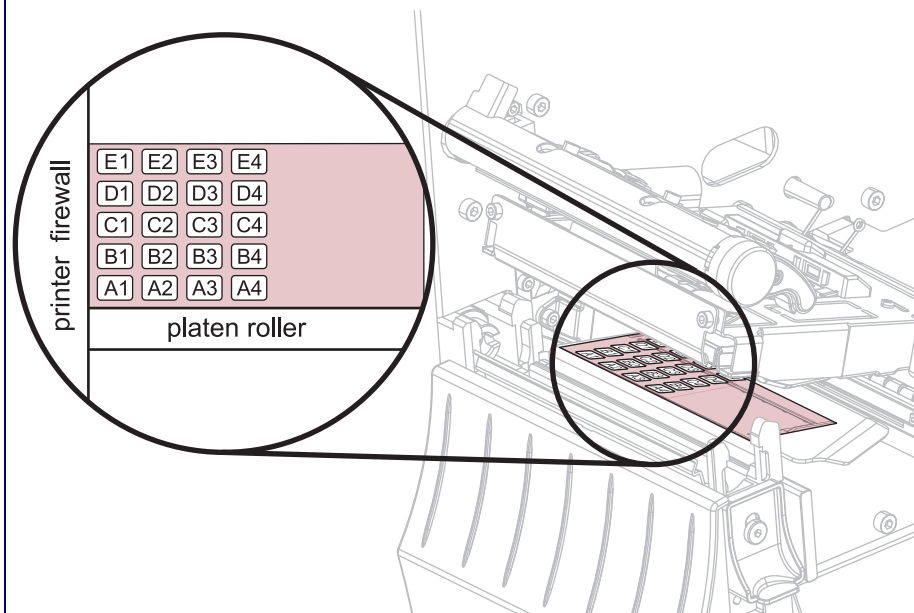
Parameters	Details
<p>a = RFID antenna element selection</p>	<p>ZD500R: This printer only has one antenna element, so the value used is always A1.</p> <p>ZT400: This parameter selects an antenna element from the printer's antenna array.</p> <p><i>Accepted Values:</i></p> <p>E1, E2, E3, E4 D1, D2, D3, D4 C1, C2, C3, C4 B1, B2, B3, B4 A1, A2, A3, A4</p>  <p><i>Default Value: A4</i></p> <p>(Continued on next page)</p>

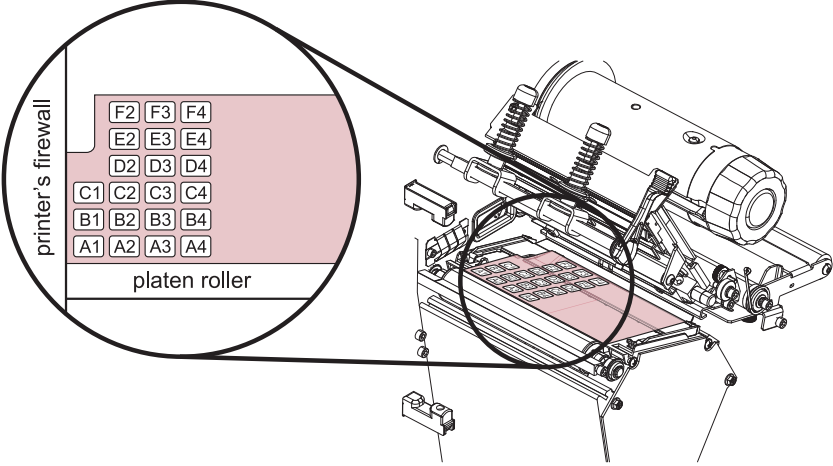
Parameters	Details
<p>a = RFID antenna element selection</p>	<p>(Continued from previous page)</p> <p>R110Xi4 (V53.17.5 and later): This parameter selects an antenna element from the printer's antenna array.</p> <p><i>Accepted Values:</i> A1, A2, A3, A4, B1, B2, B3, B4, C1, C2, C3, C4, D2, D3, D4, E2, E3, E4, F2, F3, F4 (combinations D1, E1, and F1 are invalid)</p>  <p><i>Default Value:</i> A4</p> <p>R110Xi HF (R65.X): This parameter selects the antenna port that provides the best results for reading and writing.</p> <p><i>Accepted Values:</i> 1 = antenna port 1 2 = antenna port 2</p> <p><i>Default Value:</i> 1</p>

- ➔ **Example 1** • The following command selects the antenna at row D, column 3 on an R110Xi4 printer:
`^RW, ,D3`
- ➔ **Example 2** • The following command sets the read/write power level to Medium and selects antenna 2 on an R110Xi HF printer:
`^RWM, ,2`
- ➔ **Example 3** • The following command sets the read and write power levels to High on an R110PAX4 printer:
`^RWH, H`

^RZ – Set RFID Tag Password and Lock Tag



Important • This command is not supported by all printers or firmware. See [Printer and Firmware Compatibility](#) on page 380 for the list of printers and firmware with which you can use this command.

Description Use this command to define a password for a tag during writing.

With Gen 2 tags, you can lock a tag's memory bank with an access password or define a kill password that can be used to permanently disable the tag. If you do not set access or kill passwords for a tag, the tag ignores any read or write commands that try to use these functions.



Note • The printer can set a kill password, but the printer cannot kill a tag.

Format ^RZp,m,l

Parameters	Details
p = password	<p>This parameter sets a password for the RFID tag.</p> <p>For tag types other than Gen 2: The password is 8 bits. The memory bank and lock style parameters are ignored. The password must be 2 hexadecimal characters long. <i>Accepted Values:</i> 00 to FF (hexadecimal) <i>Default Value:</i> 00</p> <p>For Gen 2 tag type only: Gen 2 tags use a 32-bit password and specify the memory bank and lock style. The password must be 8 hexadecimal characters long. Use ^RF on page 398 to read the passwords. <i>Accepted Values:</i> 00000000 to FFFFFFFF (hexadecimal) <i>Default Value:</i> none</p>
m = memory bank	<p> Note • This parameter applies to Gen 2 tags only.</p> <p>This parameter specifies the type of RFID tag password. <i>Accepted Values:</i> K = kill password A = access password E = EPC T = tag identifier (TID) U = user <i>Default Value:</i> none</p>

Parameters	Details
1 = lock style	 Note • This parameter applies to Gen 2 tags only. This parameter specifies the RFID tag password status. <i>Accepted Values:</i> U = unlocked L = locked O = permanently unlocked (open) P = permanently locked (protected) W = write value (used only for the kill password memory bank) <i>Default Value:</i> none

➔ **Example 1** • On a tag that is not Gen 2, this example encodes 5A as the tag password.

```
^XA
^RZ5A^FS
^XZ
```

➔ **Example 2** • On a Gen 2 tag, this example encodes EPC data 112233445566778899001122 to the tag in Hex format, write protects the tag's EPC data with password 1234ABCD, and leaves the tag's access password unlocked.

```
^XA
^RFW,H^FD112233445566778899001122^FS
^RZ1234ABCD,E,L^FS
^XZ
```

➔ **Example 3** • On a Gen 2 tag, this example encodes EPC data 112233445566778899001122 to the tag in Hex format, write protects the tag's EPC data with password 1234ABCD, and makes the tag's access password unreadable.

```
^XA
^RFW,H^FD112233445566778899001122^FS
^RZ1234ABCD,E,L^FS
^RZ1234ABCD,A,L^FS
^XZ
```

The following code unprotects EPC data 112233445566778899001122 using the password 1234ABCD, encodes EPC data *newdata* to the tag in ASCII format, and then write protects the tag's new EPC data. The access password and its lock state are not changed, so the access password remains unreadable.

```
^XA
^RZ1234ABCD,E,U^FS
^RFW,A^FDnewdata^FS
^RZ1234ABCD,E,L^FS
^XZ
```

➔ **Example 4** • This example unlocks the locked access password from the previous example.

```
^XA
^RZ1234ABCD,A,U^FS
^XZ
```

^WF – Encode AFI or DSFID Byte



Important • This command is not supported by all printers or firmware. See [Printer and Firmware Compatibility](#) on page 380 for the list of printers and firmware with which you can use this command.

Description Use this command to encode the AFI or DSFID byte to a tag. Error handling is set by the ^RS command.

Format ^WFr,m,w,f,b

Parameters	Details
r = number of retries	<i>Accepted values:</i> 0 to 10 <i>Default value:</i> 0
m = motion	<i>Accepted values:</i> 0 = Feed label after writing. 1 = No Feed after writing. Other ZPL may cause a feed. <i>Default value:</i> 0
w = write protect	<i>Accepted values:</i> 0 = Not write protected 1 = Write protect <i>Default value:</i> 0
f = data format	<i>Accepted values:</i> 0 = ASCII 1 = Hexadecimal <i>Default value:</i> 0
b = type of byte to read	<i>Accepted values:</i> A = AFI byte D = DSFID byte <i>Default value:</i> A



Example 1 • This example encodes data “R” (hex 52) as the AFI byte. The printer will try the command up to five times, if necessary.

```
^XA
^WF5^FDR
^XZ
```



Example 2 • This example encodes data hex 66 as the AFI byte. The printer will try the command up to three times, if necessary.

```
^XA
^WF3,,,1^FD66
^XZ
```



Example 3 • This example encodes data hex 77 as the DSFID byte. The printer will try the command up to four times, if necessary.

```
^XA
^WF4,,,1,D^FD77
^XZ
```

^WT – Write (Encode) Tag



Note • The ^WT command is provided only for backward-compatibility with label formats that were developed for older Zebra RFID printers. See [Printer and Firmware Compatibility on page 380](#) for the list of printers and firmware with which you should not use this command.

Description Use this command to encode the current RFID tag. Check the amount of data memory available for the tag that you will be using. If you send more data than the memory can hold, the printer truncates the data.

Format ^WT**b,r,m,w,f,v**

Parameters	Details
b = block number	<p>Specifies the block number to encode. This parameter is tag-dependent.</p> <ul style="list-style-type: none"> For most tags, use block 0. For EPC Class 0 Plus, block 0 is EPC data, and block 1 is user data. For the R4Mplus, this parameter does not apply to printers with firmware version SP902X. With other versions of firmware in this printer, you can encode 12 bytes (96 bits) to block 0, but you can encode only the first byte of block 1. <p><i>Accepted Values:</i> 0 to <i>n</i>, where <i>n</i> is the maximum number of blocks for the tag. <i>Default Value:</i> 0</p>
r = number of retries	<p>Changes the number of times that the printer attempts to encode a particular block of a single RFID tag. (Same function as the ^RR command.)</p> <p><i>Accepted Values:</i> 0 to 10 <i>Default Value:</i> 0</p>
m = motion	<p>Enables or disables RFID motion. (Same function as the ^RM command.)</p> <p><i>Accepted Values:</i></p> <ul style="list-style-type: none"> 0 = Feed label after writing 1 = No feed after writing (other ZPL may cause a feed) <p><i>Default Value:</i> 0</p>
w = write protect	<p><i>Accepted Values:</i></p> <ul style="list-style-type: none"> 0 = Not write protected 1 = Write protected <p><i>Default Value:</i> 0</p>
f = data format	<p><i>Accepted Values:</i></p> <ul style="list-style-type: none"> 0 = ASCII 1 = Hexadecimal <p><i>Default Value:</i> 0</p>

Parameters	Details
<p>For the R110Xi HF: v = reverse the data order</p> <p>For other supported printers: v = verify valid data</p>	<p>This parameter is not used in the R2844-Z.</p> <p>For the R110Xi HF: Reverses the data order.</p> <p><i>Accepted Values:</i></p> <p>N = Do not reverse the data order (Most significant byte first for Tag*It and PicoTag. Last significant byte first for I*code and ISO 15693)</p> <p>Y = Reverse the data order</p> <p><i>Default Value:</i> N</p> <p>For other supported printers: For reliability, some manufacturers encode tags with known data (such as A5A5). This parameter flags whether the preprogrammed data is verified. (Same function as the ^wV command.)</p> <p><i>Accepted Values:</i></p> <p>N = Do not verify</p> <p>Y = Verify valid data before writing</p> <p><i>Default Value:</i> N</p>



Example • This sample encodes data “RFIDRFID” and will try writing up to five times, if necessary.

```
^XA
^WT,5^FDRFIDRFID^FS
^XZ
```

^WV – Verify RFID Encoding Operation



Important • This command is not supported by all printers or firmware. See [Printer and Firmware Compatibility on page 380](#) for the list of printers and firmware with which you can use this command.

Description Use this command to enable or disable the write verify function. When write verify is enabled, this command verifies the RFID encoding operation to ensure that the tag about to be programmed contains the hex data “A5A5” in the first two bytes. This parameter is not persistent (carried over from label to label).

Format ^WVe

Parameters	Details
e = enable	<i>Accepted values:</i> Y or N <i>Default value:</i> N

ZPL Wireless Commands

This section contains ZPL commands for the Wireless and Wireless Plus print servers.

^KC – Set Client Identifier (Option 61)

Description The ^KC command allows the print server to have its own client identifier (CID).

Format ^KCa,b,c,d

Parameters	Details
a = enable or disable	<p><i>Accepted Values:</i></p> <ul style="list-style-type: none"> 0 = disable (default) 1 = enabled, use MAC address 2 = enabled, ASCII value 3 = enabled, HEX value <p><i>Default Value:</i> 0</p>
b = device	<p><i>Accepted Values:</i></p> <ul style="list-style-type: none"> 0 = all devices 1 = wireless 2 = external wired ^a 3 = internal wired <p><i>Default Value:</i> 1</p>
c = prefix (optional)	<p><i>Accepted Values:</i> 11 ASCII characters or 22 hexadecimal values. The prefix can be cleared by defaulting the network settings on the printer.</p>
d = identifier	<p><i>Accepted Values:</i> 60 ASCII characters or 120 hexadecimal values. Minimum field length is 2 bytes. The suffix can be cleared by defaulting the network settings on the printer.</p>

- a.** This applies only to the Xi4, RXi4, ZM400, ZM600, RZ400, or RZ600 printers when it is used with the external ZebraNet 10/100 print server using firmware v1.1.5 or later.

^NB – Search for Wired Print Server during Network Boot

Description Use this command to tell the printer whether to search for a wired print server at bootup. This command is ignored on the Xi4, RXi4, ZM400, ZM600, RZ400, and RZ600 printers.



Note • Only one print server can be installed in the S4M at one time, so this check does not occur.

Table 23 identifies which device becomes the active print server under different conditions.

Table 23 • Results of Check for Wired Print Server

If the Check for Wired Print Server is set to:	Installed and Connected to a Live Ethernet Network		Then, the Active Print Server will be:
	Wired	Wireless ^a	
Skip	X	X	Wireless
	X		Wired
		X	Wireless
Check	X	X	Wired
	X		Wired
		X	Wireless

a. A wireless option board must have an active radio that can properly associate to an access point.

Format ^NBa

Parameters	Details
a = check for wired print server at boot time	<p><i>Accepted Values:</i></p> <p>C = CHECK</p> <p>S = SKIP CHECK</p> <p><i>Default:</i> S</p>

^NN – Set SNMP

Description Use this command to set the Simple Network Management Protocol (SNMP) parameters.

Format ^NNa,b,c,d,e,f

Parameters	Details
a = system name	Same as printer name. <i>Accepted Values:</i> Up to 17 alphanumeric characters
b = system contact	Any contact information as desired (such as a name or phrase) <i>Accepted Values:</i> Up to 50 alphanumeric characters
c = system location	The printer's model information. <i>Accepted Values:</i> Up to 50 alphanumeric characters
d = get community name	<i>Accepted Values:</i> Up to 19 alphanumeric characters <i>Default Value:</i> public
e = set community name	<i>Accepted Values:</i> Up to 19 alphanumeric characters <i>Default Value:</i> public
f = trap community name	<i>Accepted Values:</i> Up to 20 alphanumeric characters <i>Default Value:</i> public

^NP – Set Primary/Secondary Device

Description Use this command to specify whether to use the printer's or the print server's LAN/WLAN settings at boot time. The default is to use the printer's settings.

When the printer is set as the primary device, you can set it up using ZPL commands or the Wireless Setup Wizard utility, and any wired print server inserted into the printer will use those settings. The drawbacks to using the printer as primary are:

Any wired print server inserted into the printer will lose its original settings if the printer is set to check for the wired print server and the Primary Device is set to **PRINTER** (see [^NB](#) on page 435).

Format ^NP`a`

Parameters	Details
<code>a</code> = device to use as primary	<i>Accepted Values:</i> P = printer M = MPS/Printserver <i>Default Value:</i> P

^NT – Set SMTP

Description Use this command to set the Simple Mail Transfer Protocol (SMTP) parameters. This allows you to set the e-mail settings for alerts.

Format ^NTa,b

Parameters	Details
a = SMTP server address	<i>Accepted Values:</i> Any properly formatted server address in the xxx.xxx.xxx.xxx format
b = print server domain	<i>Accepted Values:</i> Any properly formatted print server domain name. A domain name is one or more labels separated by a period (“dot”), and a label consists of letters, numbers, and hyphens. An example of a domain name is zebra.com

^NW – Set Web Authentication Timeout Value

Description Use this command to set the timeout value for the printer home page. The printer will prompt for the printer password only the first time that certain screens are accessed until 1) the web authentication timeout value is reached (default value is 5 minutes) or 2) the printer is reset. At that time, the printer will prompt for the password again.

Format ^NWa

Parameters	Details
a = timeout value	The timeout value in minutes for an IP address to be authenticated to the printer web pages. <i>Accepted Values:</i> 0 (no secure pages can be accessed without entering the printer password) to 255 minutes <i>Default:</i> 5

^WA – Set Antenna Parameters

Description Use this command to set the values for the receive and transmit antenna.

Format ^WAa,b

Parameters	Details
a = receive antenna	<p><i>Accepted Values:</i></p> <ul style="list-style-type: none"> D = diversity L = left R = right <p><i>Default Value:</i> D</p>
b = transmit antenna	<p><i>Accepted Values:</i></p> <ul style="list-style-type: none"> D = diversity L = left R = right <p><i>Default Value:</i> D</p>

^WE – Set WEP Mode





Note • The ^WE command is provided only for backward-compatibility with printers using firmware prior to V50.15.x, V53.15.x, or X60.15.x. For these firmware versions and later, use ^WX on page 452 to set the security type and related parameters.

Description Use this command to command enable Wired Equivalent Privacy (WEP) mode and set WEP values. WEP is a security protocol for wireless local area networks (WLANs).

Be careful to include the exact number of commas required for this command when setting encryption keys (parameters e through h). A missing or extra comma will cause the keys to be stored in the wrong slots and can prevent the printer from joining the wireless network.

Format ^WEa,b,c,d,e,f,g,h

Parameters	Details
a = encryption mode	<p><i>Accepted Values:</i></p> <p>OFF</p> <p>40 = 40-bit encryption</p> <p>128 = 128-bit encryption</p> <p><i>Default Value:</i> OFF</p>
b = encryption index	<p>Tells the printer which encryption key to use.</p> <p><i>Accepted Values:</i></p> <p>1 = Key 1</p> <p>2 = Key 2</p> <p>3 = Key 3</p> <p>4 = Key 4</p> <p><i>Default Value:</i> 1</p>
c = authentication type	<p><i>Accepted Values:</i> O (Open System), S (Shared Key)</p> <p>O = Open System</p> <p>S = Shared Key</p> <p><i>Default Value:</i> O</p> <p> Note • If you enable Shared Key authentication with Encryption Mode set to OFF, this value resets to O (Open).</p>
d = encryption key storage	<p><i>Accepted Values:</i> H (Hex key storage), S (string key storage)</p> <p>H = Hex key storage</p> <p>S = String key storage</p> <p><i>Default Value:</i> H</p>

Parameters	Details
e, f, g, h = encryption keys 1 through 4	<p><i>Accepted Values:</i> The actual value for the encryption key</p> <p>The encryption mode affects what can be entered for the encryption keys:</p> <ul style="list-style-type: none"> • For 40-bit, encryption keys can be set to any 5 hex pairs or any 10 alphanumeric characters. • For 128-bit, encryption keys can be set to any 13 hex pairs or any 26 alphanumeric characters. <p> Note • When using hex storage, do not add a leading 0x on the WEP key.</p>

➔ **Example 1** • This example sets encryption to 40-bit, activates encryption key 1, and sets encryption key 1 to the string 12345.

`^WE40,,,12345`

In this example, the Encryption Index, Authentication Type, and Encryption Key Storage parameters are left blank with commas as placeholders for the fields. The printer uses the default values for these parameters.

➔ **Example 2** • This example sets encryption to 128-bit, activates encryption key 2, and sets encryption keys 1 and 2 to hex values.

`^WE128,2,,H,12345678901234567890123456,98765432109876543210987654`

The value for encryption key 1 is stored and can be activated in the future by the following command:

`^WE128,1`

➔ **Example 3** • This example sets encryption to 128-bit, activates encryption key 4, and sets encryption key 4 to a hex value.

`^WE128,4,,H,,,98765432109876543210987654`

Values are not required for encryption keys 1 through 3 when setting encryption key 4. In this example, commas are used as placeholders for the fields for encryption keys 1 through 3. Any previously stored values for these encryption keys do not change.



Important • Make sure that you include the exact number of commas required to get to the slot for encryption key 4 (parameter h).

^WI – Change Wireless Network Settings

Description Use this command to change the wireless network settings.

Zebra recommends using [^ND on page 314](#) for these settings if you have any of the following printers:

- Xi4 printers with firmware V53.17.1Z or later
- RXi4 printers with firmware V53.17.7Z or later
- ZM400, ZM600, or S4M printers with firmware V53.15.xZ or later
- RZ400/RZ600 printers with firmware R53.16.x or later

Format ^WIa,b,c,d,e,f,g,h,i

Parameters	Details
a = IP resolution	<p><i>Accepted Values:</i></p> <p>A = All B = BOOTP C = DHCP and BOOTP D = DHCP G = Gleaning only (Not recommended when the Wireless Print Server or Wireless Plus Print Server is installed.) R = RARP P = Permanent</p> <p><i>Default Value:</i> A</p>
b = IP address	<p><i>Accepted Values:</i> Any properly formatted IP address in the xxx.xxx.xxx.xxx format.</p> <p><i>Default Value:</i> 000.000.000.000</p>
c = subnet mask	<p><i>Accepted Values:</i> Any properly formatted subnet mask in the xxx.xxx.xxx.xxx format.</p> <p><i>Default Value:</i> 000.000.000.000</p>
d = default gateway	<p><i>Accepted Values:</i> Any properly formatted gateway in the xxx.xxx.xxx.xxx format.</p> <p><i>Default Value:</i> 000.000.000.000</p>
e = WINS server address	<p><i>Accepted Values:</i> Any properly formatted WINS server in the xxx.xxx.xxx.xxx format.</p> <p><i>Default Value:</i> 000.000.000.000</p>
f = connection timeout checking	<p><i>Accepted Values:</i></p> <p>Y = yes N = no</p> <p><i>Default Value:</i> Y</p>
g = timeout value	<p>Time, in seconds, before the connection times out.</p> <p><i>Accepted Values:</i> 0 through 9999</p> <p><i>Default Value:</i> 300</p>

Parameters	Details
h = ARP broadcast interval	Time, in minutes, that the broadcast is sent to update the device's ARP cache. <i>Accepted Values:</i> 0 through 30 <i>Default Value:</i> 0 (no ARP sent)
i = base raw port number	The port number that the printer should use for its RAW data. <i>Accepted Values:</i> 1 through 65535 <i>Default Value:</i> 9100

^WL – Set LEAP Parameters



Note • The ^WL command is provided only for backward-compatibility with printers using firmware prior to V50.15.x or X60.15.x. For these firmware versions and later, use ^WX on page 452 to set the security type and related parameters.

Description Use this command to enable Cisco® Lightweight Extensible Authentication Protocol (LEAP) mode and set parameters. LEAP is user authentication method that is available with some wireless radio cards.

Format ^WL*a,b,c*

Parameters	Details
a = mode	<i>Accepted Values:</i> OFF, ON <i>Default Value:</i> OFF
b = user name	<i>Accepted Values:</i> Any 1 to 32 alphanumeric including special characters <i>Default Value:</i> user
c = password	<i>Accepted Values:</i> Any 1 to 32 alphanumeric including special characters <i>Default Value:</i> password

~WL - Print Network Configuration Label

Description Use this command to generate a network configuration label (Figure 3).

Format ~WL

Figure 3 • Network Configuration Label

Wireless Print Server

Network Configuration	
Zebra Technologies ZTC 140xi11IPPlus-200dpi ZBR3258042	
NO.....	WIRED PS CHECK?
Printer.....	LOAD LAN FROM?
Wired	
ALL.....	IP PROTOCOL
000.000.000.000.....	IP ADDRESS
000.000.000.000.....	SUBNET MASK
000.000.000.000.....	DEFAULT GATEWAY
000.000.000.000.....	WINS SERVER IP
YES.....	TIMEOUT CHECKING
0300.....	TIMEOUT VALUE
0000.....	ARP INTERVAL
9100.....	BASE RAW PORT
Wireless*	
ALL.....	IP PROTOCOL
010.003.015.030.....	IP ADDRESS
255.255.255.000.....	SUBNET MASK
000.000.000.000.....	DEFAULT GATEWAY
000.000.000.000.....	WINS SERVER IP
YES.....	TIMEOUT CHECKING
0300.....	TIMEOUT VALUE
0000.....	ARP INTERVAL
9100.....	BASE RAW PORT
YES.....	CARD INSERTED
015FH.....	CARD MFG ID
000AH.....	CARD PRODUCT ID
5.02.19.....	CARD FIRMWARE
00082131b6ba.....	MAC ADDRESS
YES.....	DRIVER INSTALLED
INFRASTRUCTURE.....	OPERATING MODE
125.....	ESSID
100.....	TX POWER
ON.....	1 Mb/s
ON.....	2 Mb/s
ON.....	5.5 Mb/s
ON.....	11 Mb/s
11 Mb/s.....	CURRENT TX RATE
DIVERSITY.....	RECEIVE ANTENNA
DIVERSITY.....	XMIT ANTENNA
YES.....	ASSOCIATED
NONE.....	WLAN SECURITY
OPEN.....	WEP TYPE
1.....	WEP INDEX
LONG.....	PREAMBLE
020.....	POOR SIGNAL

FIRMWARE IN THIS PRINTER IS COPYRIGHTED

**Wireless Plus Print Server
and Internal Wireless Plus Print Server**

**Xi4, R110Xi4, ZM400, ZM600,
RZ400, RZ600**

Network Configuration	
Zebra Technologies PRINTER NAME ZBR2934792	
0.0.0.*.....	OPTION FIRMWARE
Wired.....	PRIMARY NETWORK
NO.....	LOAD FROM EXT?
Internal Wired.....	ACTIVE PRINTSRVR
External Wired	
ALL.....	IP PROTOCOL
000.000.000.000.....	IP ADDRESS
255.255.255.000.....	SUBNET MASK
000.000.000.000.....	DEFAULT GATEWAY
000.000.000.000.....	WINS SERVER IP
YES.....	TIMEOUT CHECKING
300.....	TIMEOUT VALUE
000.....	ARP INTERVAL
9100.....	BASE RAW PORT
Internal Wired*	
ALL.....	IP PROTOCOL
010.003.004.116.....	IP ADDRESS
255.255.255.000.....	SUBNET MASK
010.003.004.001.....	DEFAULT GATEWAY
010.003.001.098.....	WINS SERVER IP
YES.....	TIMEOUT CHECKING
300.....	TIMEOUT VALUE
000.....	ARP INTERVAL
9100.....	BASE RAW PORT
00074d2b4168.....	MAC ADDRESS
Wireless	
ALL.....	IP PROTOCOL
000.000.000.000.....	IP ADDRESS
255.255.255.000.....	SUBNET MASK
000.000.000.000.....	DEFAULT GATEWAY
000.000.000.000.....	WINS SERVER IP
YES.....	TIMEOUT CHECKING
300.....	TIMEOUT VALUE
000.....	ARP INTERVAL
9100.....	BASE RAW PORT
NO.....	CARD INSERTED
0000H.....	CARD MFG ID
0000H.....	CARD PRODUCT ID
000000000000.....	MAC ADDRESS
YES.....	DRIVER INSTALLED
INFRASTRUCTURE.....	OPERATING MODE
125.....	ESSID
100.....	TX POWER
ON.....	1 Mb/s
ON.....	2 Mb/s
ON.....	5.5 Mb/s
ON.....	11 Mb/s
11 Mb/s.....	CURRENT TX RATE
DIVERSITY.....	RECEIVE ANTENNA
DIVERSITY.....	XMIT ANTENNA
YES.....	ASSOCIATED
NONE.....	WLAN SECURITY
OPEN.....	WEP TYPE
1.....	WEP INDEX
LONG.....	PREAMBLE
15.....	PULSE RATE
ON.....	PULSE ENABLED
15.....	PULSE RATE
ON.....	INTL MODE
07FFH.....	CHANNEL MASK

FIRMWARE IN THIS PRINTER IS COPYRIGHTED

**Other Printers/
Print Engines**

Network Configuration	
Zebra Technologies ZTC 105SL-200dpi ZBR12308662	
1.10.1729.....	OPTION FIRMWARE
NO.....	WIRED PS CHECK?
Printer.....	LOAD LAN FROM?
Wired	
ALL.....	IP PROTOCOL
000.000.000.000.....	IP ADDRESS
000.000.000.000.....	SUBNET MASK
000.000.000.000.....	DEFAULT GATEWAY
000.000.000.000.....	WINS SERVER IP
YES.....	TIMEOUT CHECKING
0300.....	TIMEOUT VALUE
0000.....	ARP INTERVAL
9100.....	BASE RAW PORT
Wireless*	
ALL.....	IP PROTOCOL
010.003.015.034.....	IP ADDRESS
255.255.255.000.....	SUBNET MASK
000.000.000.000.....	DEFAULT GATEWAY
000.000.000.000.....	WINS SERVER IP
YES.....	TIMEOUT CHECKING
0300.....	TIMEOUT VALUE
0000.....	ARP INTERVAL
9100.....	BASE RAW PORT
YES.....	CARD INSERTED
015FH.....	CARD MFG ID
000AH.....	CARD PRODUCT ID
5.60.21.....	CARD FIRMWARE
00084c4f876.....	MAC ADDRESS
YES.....	DRIVER INSTALLED
INFRASTRUCTURE.....	OPERATING MODE
125.....	ESSID
100.....	TX POWER
ON.....	1 Mb/s
ON.....	2 Mb/s
ON.....	5.5 Mb/s
ON.....	11 Mb/s
11 Mb/s.....	CURRENT TX RATE
DIVERSITY.....	RECEIVE ANTENNA
DIVERSITY.....	XMIT ANTENNA
YES.....	ASSOCIATED
NONE.....	WLAN SECURITY
OPEN.....	WEP TYPE
1.....	WEP INDEX
LONG.....	PREAMBLE
020.....	POOR SIGNAL
ON.....	PULSE ENABLED
15.....	PULSE RATE
ON.....	INTL MODE
07FFH.....	CHANNEL MASK

FIRMWARE IN THIS PRINTER IS COPYRIGHTED

^WP – Set Wireless Password



Note • This command does not apply to the S4M.

Description Use this command to set the four-digit wireless password (not the same as the general printer password). If the wireless password is **0000**, the Wireless and Wireless Plus print servers run in an “unprotected” mode, which means that you do not need to enter the wireless password through the control panel to view or modify wireless settings.

If a wireless password is set, the values for the following parameters will not appear through the control panel until the wireless password is entered:

- MAC Address
- ESSID
- WLAN Security
- WEP Type
- WEP Index
- Reset Network

Format ^WP a, b

Parameters	Details
a = old wireless password	<i>Accepted Values:</i> 0000 through 9999 <i>Default Value:</i> 0000
b = new wireless password	<i>Accepted Values:</i> 0000 through 9999 <i>Default Value:</i> 0000

^WR – Set Transmit Rate

Description Use this command to change the transmission rate for 802.11b wireless print servers.

Format ^WRa,b,c,d,e

Parameters	Details
a = rate 1	Sets the 1 Mb/s transmit rate. <i>Accepted Values:</i> Y (On), N (Off)
b = rate 2	Sets the 2 Mb/s transmit rate. <i>Accepted Values:</i> Y (On), N (Off)
c = rate 5.5	Sets the 5.5 Mb/s transmit rate. <i>Accepted Values:</i> Y (On), N (Off)
d = rate 11	Sets the 11 Mb/s transmit rate. <i>Accepted Values:</i> Y (On), N (Off)
e = transmit power	<i>Accepted Values:</i> 1, 5, 20, 30, 50, 100

~WR – Reset Wireless Radio Card and Print Server



Description Use this command to reinitialize the wireless radio card and the print server (wired or wireless) when the Wireless or Wireless Plus print server is running. The command also causes any wireless radio card in the printer to reassociate to the wireless network.

Format ~WR

^WS – Set Wireless Radio Card Values

Description Use this command to set the wireless radio card values for ESSID, Operating Mode, and Card Preamble.

Format ^WSe,o,p,h,i,j,k

Parameters	Details
e = ESSID value	<i>Accepted Values:</i> Any value up to 32 characters, including all ASCII and Extended ASCII characters, including the space character. When this parameter is left blank, the ESSID is not changed. <i>Default Value:</i> 125
o = operating mode	<i>Accepted Values:</i> I (Infrastructure), A (Adhoc) <i>Default Value:</i> I
p = wireless radio card preamble	<i>Accepted Values:</i> L = long S = short <i>Default Value:</i> L
h = wireless pulse  This parameter is supported in firmware version V60.15.x, V50.15.x, R6x.15.x, R53.15.x, ZSPx, or later.	Adds a pulse to the network traffic generated by the printer. This pulse is necessary with some network configurations to keep the printer online. <i>Accepted Values:</i> 0 = disabled 1 = enabled <i>Default Value:</i> 1
i = wireless pulse interval  This parameter is supported in firmware version V60.15.x, V50.15.x, R6x.15.x, R53.15.x, ZSPx, or later.	Sets the interval at which the wireless pulse is sent when the wireless pulse feature is enabled. <i>Accepted Values:</i> 5 to 300 seconds <i>Default Value:</i> 15
j = channel mask  This parameter is supported in firmware version X60.15.x, V50.15.x, or later.	For commonly used channel masks, see Table 24 . <i>Accepted Values:</i> 4 Hexadecimal digits preceded by “0x” (0x0000 to 0xFFFF) <i>Default Value:</i> 0x7FF

Parameters	Details
k = international mode  This parameter is supported in firmware version X60.15.x, V50.15.x, or later.	<i>Accepted Values:</i> 0 (Disabled), 1 (Enabled) <i>Default Value:</i> 0

Table 24 • Channel Mask Settings

Region	Channel Mask
United States, Canada, Latin America	0x7FF
Europe, Middle East, Africa, other	0x1FFF
Japan	0x3FFF

^WX – Configure Wireless Securities

Description Use this command to configure the wireless security settings for your printer. Values entered for this command must match what is configured on your WLAN and must be supported by the wireless radio card that you are using.

The ^WX command replaces individual ZPL commands for different security types.



This command applies to printers with firmware version X60.15.x, V53.15.x, V50.15.x, or later.



Note • When using certificate files, your printer supports:

- Using Privacy Enhanced Mail (PEM) formatted certificate files.
- Using the client certificate and private key as two files, each downloaded separately.
- Using exportable PAC files for EAP-FAST.



Important • When using certificate files, the time on the printer must be set correctly for the websocket connection to succeed, as the time is used in the certificate validation.



Format ^WXa,[zero or more supporting parameters]



Note • The supporting parameters that are required vary based on the security type that you select. See [Supporting Parameters for Different Security Types on page 455](#) for instructions for each security type.

Parameters	Details																
a = security type	<p>Enter the two-digit code for the security type that your WLAN uses. For which supporting parameters (b through n) to use with the different security types, see Supporting Parameters for Different Security Types on page 455.</p> <p> Note • Configuring the printer for WPA also allows the printer to be used in WPA2 environments.</p> <p><i>Accepted Values: 01 to 15</i></p> <table> <tr> <td>01 = No wireless security is active</td> <td>09 = WPA PSK (R6x15.x, R53.15.x, ZSPx, and later.)</td> </tr> <tr> <td>02 = WEP 40-bit</td> <td>10 = WPA EAP-TLS</td> </tr> <tr> <td>03 = WEP 128-bit</td> <td>11 = WPA EAP-TTLS</td> </tr> <tr> <td>04 = EAP-TLS</td> <td>12 = WPA EAP-FAST</td> </tr> <tr> <td>05 = EAP-TTLS</td> <td>13 = WPA PEAP</td> </tr> <tr> <td>06 = EAP-FAST</td> <td>14 = WPA LEAP</td> </tr> <tr> <td>07 = PEAP</td> <td>15 = Kerberos</td> </tr> <tr> <td>08 = LEAP</td> <td></td> </tr> </table> <p><i>Default Value: 01</i></p>	01 = No wireless security is active	09 = WPA PSK (R6x15.x, R53.15.x, ZSPx, and later.)	02 = WEP 40-bit	10 = WPA EAP-TLS	03 = WEP 128-bit	11 = WPA EAP-TTLS	04 = EAP-TLS	12 = WPA EAP-FAST	05 = EAP-TTLS	13 = WPA PEAP	06 = EAP-FAST	14 = WPA LEAP	07 = PEAP	15 = Kerberos	08 = LEAP	
01 = No wireless security is active	09 = WPA PSK (R6x15.x, R53.15.x, ZSPx, and later.)																
02 = WEP 40-bit	10 = WPA EAP-TLS																
03 = WEP 128-bit	11 = WPA EAP-TTLS																
04 = EAP-TLS	12 = WPA EAP-FAST																
05 = EAP-TTLS	13 = WPA PEAP																
06 = EAP-FAST	14 = WPA LEAP																
07 = PEAP	15 = Kerberos																
08 = LEAP																	

* Not used for all security types

Parameters	Details
b = WEP encryption index*	<p>Specifies which encryption key to use for WEP encryption. A value must be specified if using WEP 40-bit or WEP 128-bit.</p> <p><i>Accepted Values:</i> 1, 2, 3, 4</p> <p><i>Default Value:</i> 1</p>
c = WEP authentication type*	<p>Enables the WEP key authentication type. A value must be specified if using WEP 40-bit or WEP 128-bit.</p> <p><i>Accepted Values:</i> 0 or S</p> <p>0 = open system S = shared key</p> <p><i>Default Value:</i> 0</p>
d = WEP key type*	<p>Specifies the format of the WEP key. A value must be specified if using WEP 40-bit or WEP 128-bit.</p> <p><i>Accepted Values:</i> H or S</p> <p>H = hex key storage S = string key storage</p> <p><i>Default Value:</i> S</p>
e,f,g,h = WEP encryption keys 1 through 4*	<p>Specifies the actual values of any WEP encryption keys to be used. A value must be specified for at least one WEP encryption key if you specify 40-bit or 128-bit WEP encryption for the security type.</p> <p> Important • Be careful to include the exact number of commas required for this command when setting encryption keys (parameters e through h). A missing or extra comma will cause the keys to be stored in the wrong slots and can prevent the printer from joining the wireless network.</p> <p>The encryption mode affects what can be entered for the encryption keys:</p> <ul style="list-style-type: none"> • For 40-bit, encryption keys can be set to any 5 hex pairs or any 10 alphanumeric characters. • For 128-bit, encryption keys can be set to any 13 hex pairs or any 26 alphanumeric characters. <p> Note • When using hex storage, do not add a leading 0x on the WEP key.</p> <p><i>Accepted Values:</i> The actual value for the encryption key</p> <p><i>Default Value:</i> None</p>

* Not used for all security types

Parameters	Details
i = user ID*	<p>Specifies a user ID for security types that require one. A value must be specified if using the following security types:</p> <ul style="list-style-type: none"> • EAP-TTLS • LEAP • WPA LEAP • PEAP • WPA PEAP • WPA EAP-TTLS • Kerberos <p><i>Accepted Values:</i> The actual value for the user ID. <i>Default Value:</i> user</p>
j = password*	<p>Specifies a password for security types that require one. A value must be specified if using the following security types:</p> <ul style="list-style-type: none"> • EAP-TTLS • LEAP • WPA LEAP • PEAP • WPA PEAP • WPA EAP-TTLS • Kerberos <p><i>Accepted Values:</i> The actual value for the password. <i>Default Value:</i> password</p>
k = optional private key password*	<p>Specifies an optional private key password for security types that require one. A value must be specified if using the following security types:</p> <ul style="list-style-type: none"> • EAP-TLS • EAP-FAST • WPA EAP-TLS • WPA EAP-FAST <p><i>Accepted Values:</i> The actual value for the optional private key. <i>Default Value:</i> None</p>
l = realm*	<p>Specifies the realm for security types that require it. A value must be specified if using Kerberos.</p> <p><i>Accepted Values:</i> The actual value for the realm. <i>Default Value:</i> kerberos</p>
m = Key Distribution Center (KDC)*	<p>Specifies the KDC for security types that require it. A value must be specified if using Kerberos.</p> <p><i>Accepted Values:</i> The actual value for the KDC. <i>Default Value:</i> krbtgt"</p>

* Not used for all security types

Parameters	Details
n = Pre-Shared Key (PSK) value*	<p>Enter the PSK value. This value is calculated and must be the same for each device on the WLAN. Use ZebraNet Bridge to generate the PSK value. A value must be specified if using WPA PSK.</p> <p> Important • Do not enter a pass phrase for this field in this command. To use a pass phrase, use the ZebraNet Bridge Enterprise Wireless Setup Wizard.</p> <p><i>Accepted Values:</i> a minimum of 64 hexadecimal digits</p> <p><i>Default Value:</i> None</p>

* Not used for all security types

Supporting Parameters for Different Security Types

The supporting parameters required for this command vary based on the security type that you select. You should not use all of the supporting parameters each time that you use this command, nor will you use extra commas to separate unused fields. Follow the example and format for your specific security type in this section, substituting your own wireless network data.

Security Type 01: No Wireless Security Active

Format ^WX01

→ **Example** • This example turns off all wireless securities controlled under this command, but it does not reset the printer's wireless settings to their defaults.

```
^XA
^WX01
^JUS^XZ
```

Security Type 02: WEP 40-Bit

Format ^WX02,b,c,d,e,f,g,h

→ **Example** • This example configures the printer for WEP 40-bit encryption using index key 1, open authentication, and a hexadecimal WEP key with a value of "A1B2C3D4F5."

```
^XA
^WX02,1,0,H,A1B2C3D4F5,,,
^JUS
^XZ
```

Security Type 03: WEP 128-Bit

Format ^WX03,b,c,d,e,f,g,h

→ **Example** • This example configures the printer for WEP 128-bit encryption using index key 2, open authentication, and four hexadecimal WEP keys.

```
^XA
^WX03,2,0,H,001122334455667788,112233445566778899,223344556677889900,334455
667788990011
^JUS
^XZ
```

Security Type 04: EAP-TLS

Format ^WX04,k

→ **Example** • This example configures the printer for EAP-TLS authentication with an optional private key password with a value of “private.”

```
^XA
^WX04,private
^JUS
^XZ
```

Security Type 05: EAP-TTLS

Format ^WX05,i,j

→ **Example** • This example configures the printer for EAP-TTLS authentication, including a user ID of “user” and a password of “password.”

```
^XA
^WX05,user,password
^JUS
^XZ
```

Security Type 06: EAP-FAST

Format ^WX06,i,j,k

→ **Example** • This example configures the printer for EAP-FAST authentication, including a user ID of “user,” a password of “password,” and an optional private key of “private.”

```
^XA
^WX06,user,password,private
^JUS
^XZ
```

Security Type 07: PEAP

Format ^WX07,i,j

→ **Example** • This example configures the printer for PEAP authentication, including a user ID with a value of “user” and a password with a value of “password.”

```
^XA
^WX07,user,password
^JUS
^XZ
```

Security Type 08: LEAP

Format ^WX08,i,j

→ **Example** • This example configures the printer for LEAP authentication, including a user ID with a value of “user” and a password with a value of “password.”

```
^XA
^WX08,user,password
^JUS
^XZ
```

Security Type 09: WPA PSK



Note • Configuring the printer for WPA also allows the printer to be used in WPA2 environments (R6x15.x, R53.15.x, ZSPx, and later.)

Format ^WX09,n

→ **Example** • This example configures the printer for WPA PSK authentication with a PSK value of all zeroes (64 hexadecimal digits).

```
^XA
^WX09,00000000...
^JUS
^XZ
```

Security Type 10: WPA EAP-TLS



Note • Configuring the printer for WPA also allows the printer to be used in WPA2 environments.

Format ^WX10,k



Example • This example configures the printer for WPA EAP-TLS authentication with an optional private key password with a value of “private.”

```
^XA
^WX10,private
^JUS
^XZ
```

Security Type 11: WPA EAP-TTLS



Note • Configuring the printer for WPA also allows the printer to be used in WPA2 environments.

Format ^WX11,i,j



Example • This example configures the printer for WPA EAP-TTLS authentication, including a user ID with a value of “user” and a password with a value of “password.”

```
^XA
^WX11,user,password
^JUS
^XZ
```

Security Type 12: WPA EAP-FAST



Note • Configuring the printer for WPA also allows the printer to be used in WPA2 environments.

Format ^WX12,i,j,k



Example • This example configures the printer for WPA EAP-FAST authentication, including a user ID of “user,” a password of “password,” and an optional private key of “private.”

```
^XA
^WX12,user,password,private
^JUS
^XZ
```

Security Type 13: WPA PEAP



Note • Configuring the printer for WPA also allows the printer to be used in WPA2 environments.

Format ^WX13,i,j



Example • This example configures the printer for WPA PEAP authentication, including a user ID with a value of “user” and a password with a value of “password.”

```
^XA
^WX13,user,password
^JUS
^XZ
```

Security Type 14: WPA LEAP



Note • Configuring the printer for WPA also allows the printer to be used in WPA2 environments.

Format ^WX14,i,j



Example • This example configures the printer for WPA LEAP authentication, including a user ID with a value of “user” and a password with a value of “password.”

```
^XA
^WX14,user,password
^JUS
^XZ
```

Security Type 15: Kerberos

Format ^WX15,i,j,l,m



Example • This example configures the printer for Kerberos encryption, including a Kerberos user ID with a value of “user,” a Kerberos password with a value of “password,” a realm of “zebra,” and a KDC of “krbtgt.”

```
^XA
^WX15,user,password,zebra,krbtgt
^JUS
^XZ
```

ZBI Commands

This section explains the Zebra Basic Interpreter, its commands, descriptions, formats, and parameters.

Command and Function Reference Format

This section describes how commands and functions are presented in this document.

Command/Function NAME

Description This heading has a description of how the command is used, its capabilities, and its characteristics.

Format The Format section explains how the command is arranged and its parameters. For example, the `AUTONUM` command starts the auto-numbering option. The format for the command is `AUTONUM <A>,`. The `<A>` and `` are parameters of this command and are replaced with values determined by the user.

For functions, parameters are enclosed within parentheses and separated by commas, such as `EXTRACT$(A$,START$,STOP$)`.

Numeric parameters are written as a name, while string parameters are written as a name followed by a dollar sign.

Parameters If a command has parameters that make a command or function more specific, they are listed under this heading. Still using the `AUTONUM` example, the `<A>` parameter is defined as:

`<A>` = number used to start the auto-numbering sequence

Return Value (functions only)

The return value is the result of evaluating the function or expression.

Example When a command is best clarified in a programming context, an example of the ZBI code is provided. Text indicating parameters, exact code to be entered, or data returned from the host is printed in the *Courier* font to be easily recognizable.



Example • An example of `PRINT` code is:

```
10 PRINT "HELLO WORLD"  
RUN  
HELLO WORLD
```

Comments This section is reserved for notes that are of value to a programmer, warnings of potential command interactions, or command-specific information that should be taken into consideration. An example comment could be: This is a program command and must be preceded by a line number.

Function Rules

Functions built into this interpreter can be used in expressions only. The function names are not case sensitive.

If input parameters exist, they are enclosed in parentheses. If no parameters exist, no parentheses are used.

Variables referenced in the functions could be substituted by functions or expressions of the same type. If the function name ends with a \$, it returns a string value. Otherwise, it returns a numeric value.

Introduction to Zebra Basic Interpreter (ZBI)

What is ZBI and why is it for me?

ZBI is an "on-the-printer" programming language that offers many of the functions found in ANSI BASIC. The ZBI language allows the user to create applications that are run on the printer to manipulate data streams. By using ZBI, it is possible to have the printer perform the same functions that a computer or programmable terminal might otherwise be used for.

With the connectivity options available on Zebra printers, you may not need a separate computer. Simply load a ZBI program on your printers, add them to your network, and let the printers serve as the gateway for moving data.

Here are some of the applications that can be written using ZBI:

- Connect a barcode scanner to the printer. Based on scanned data, reprint tags, verify printed output, and manage a list of items.
- Connect a scale to the printer and print labels, tags, or receipts based on the weight of an item.
- Connect the printer to a PC-based database and send queries from the printer to retrieve or upload data.
- Convert incoming data into the commands that can be used to print a label. This is useful for replacing other brands of printers with new Zebra units.
- Provide fail-over to another printer when the target printer is in an error state.

Printers, ZBI Keys, & ZBI Versions

Information about ZBI 1.x and ZBI 2.x:

ZBI versions 1.0 through 1.5: ZBI 1.x was available on printers with X.10 or higher firmware (such as V48.10.x). To determine if the printer supports ZBI version 1, check the firmware version loaded on the printer. This can be determined by the absence of a “Z” in the firmware version number (for example, firmware V60.13.0.12 supports ZBI version 1, while V60.13.0.12Z does not). The following printers support the ZBI 1.x firmware:

- *LP/TLP 284x-Z and 384x-Z*
- *S300/S400/S500/S600*
- *Z4000/Z6000*
- *Z4M/Z6M*
- *Z4Mplus/Z6Mplus*
- *105SL*
- *PAX3*
- *XiII*
- *XiIII*

ZBI-Developer can be used to create programs for use on printers that support ZBI version 1.x., however, the features that are only available in ZBI v2.x cannot be used with printers running ZBI v1.x. For example, “on-printer” debugging advanced file encryption and commands added in ZBI 2 are not supported in printers running ZBI 1.x. If you do not have a printer that meets this requirement, contact your reseller.



Note • Support for ZBI versions 1.0 through 1.5 is limited to syntax checking only. On-printer debugging is not supported for ZBI versions 1.0 through 1.5.



ZBI versions 2.0 and higher: Printers with firmware versions X.16 or later (for example, V60.16.x and V53.16.x) can support ZBI version 2.0 and later. The following printers support the ZBI 2.x firmware:

- *XiIII Plus*
- *Z4Mplus/Z6Mplus*
- *105SL*
- *S4M*
- *PAX4*
- *ZM400/ZM600, RZ400/RZ600*
- *G-Series*
- *HC100*
- *Xi4, RXi4*
- *LP/TLP2824+*
- *KR403*

These printers can be either ZBI-Ready or ZBI-Enabled, depending on whether or not a ZBI Key file has been loaded on the printer. ZBI Keys can be loaded onto printers during manufacturing or later purchased at www.zebrasoftware.com. A Downloader Utility/ZBI Key Manager software utility is available to assist in the task of sending ZBI Keys to printers.

The ZBI.nrd file is required to be present on the printer for ZBI 2.0 to be enabled. The ZBI Key is stored on the printer's E: memory location with the name ZBI.nrd. The file is persistent. It cannot be deleted even if the printer's memory is initialized. For example, if the `^JB` command is used to initialize the location, the ZBI Key file will not be deleted.

When a printer is ZBI-Ready but not ZBI-Enabled, the firmware version will display a "Z" at the end of the version string (for example, V60.16.0Z). Additionally, the printer's configuration label will show that the printer is not ZBI-Enabled.

When a printer is ZBI-Enabled, the firmware version will not display a "Z" at the end of the version string (for example, V60.16.0). Additionally, the printer's configuration label will show that the printer is ZBI-Enabled.



Note • Each single ZBI Key can only be used once. When multiple printers are to be ZBI-Enabled multiple Keys will be needed. The ZBI Key cannot be retrieved from printer to a host system.

Section Organization

The sections in this guide are arranged based on programming topics. A brief description of the sections is listed below.

Editing Commands This section describes the commands which are used to manipulate the interpreter and enter programs.

Running and Debugging Outlines the control commands used to run and debug programs.

Base Types and Expressions Fundamental structure for manipulating strings and computing numeric and boolean values.

Control and Flow Commands to conditionally execute code and control the flow of the program

Input and Output Outlines how to communicate with the physical ports, internal ports, and network.

File System Shows how programs and formats can be saved and recalled

Comma Separated Values Identifies how to load and store comma separated data

Events Explains how to capture and trigger internal events in the printer

Systems Contains miscellaneous systems interface functions

String Functions Handles string manipulation

Math Functions Handles mathematical calculations

Array Functions Describes how to search, resize, and query arrays

Time and Date Functions Functions to access the real time clock option

Set/Get/Do Interface Functions to directly interface with the Set/Get/Do system

Example Programs More examples to give a head start in creating your applications

Writing ZBI Programs

There are two main ways to develop ZBI programs. The preferred method is to use the ZBI-Developer application. ZBI-Developer allows you to create and test programs before a printer is even turned on. In addition, many features of this program allow for quicker program creation and more meaningful debugging. ZBI-Developer can be downloaded from the Zebra web site.

An alternate method for developing a program is through a direct connection to the printer using a terminal emulation program.

Editing Commands

This section details the Editing Commands. This section describes the commands which are used to manipulate the interpreter and enter programs. These commands are used while controlling the ZBI environment from a console connection. Here is a quick list of these commands:

NEW – Clears out the program and variables currently in memory

REM and ! – Comment commands

LIST – Lists the program currently in memory

AUTONUM – Automatically generates the next line number

RENUM – Renumbers the program currently in memory

ECHO – Controls whether characters received on the console are echoed back

If you are using ZBI-Developer, the commands that will be most useful are AUTONUM and REM/!.

The following example shows the use of Editing commands from within a console connection.

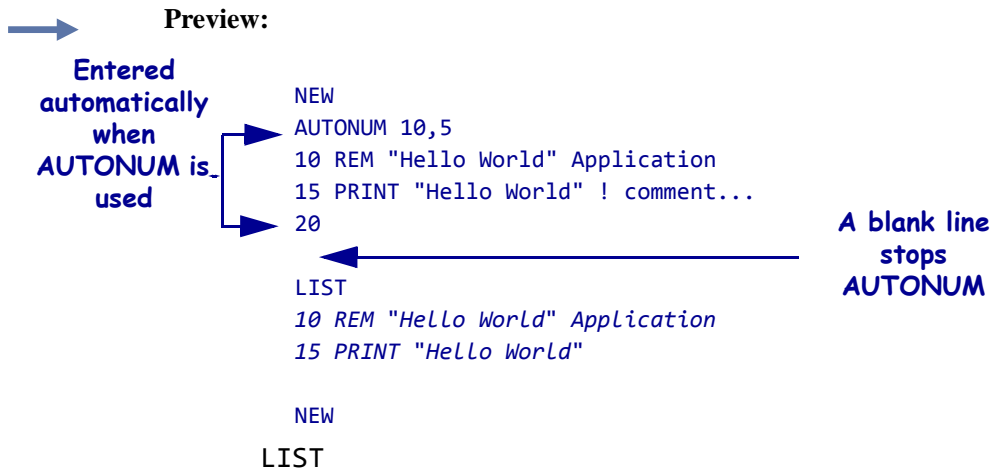

→ **Preview when viewed in ZBI-Developer**

```
AUTONUM 10,5
REM "Hello World" Application
PRINT "Hello World" ! comment...
```

NEW

Description This command clears the interpreter's memory, including the line buffer and variables, but not any open ports. Use this command when creating code to restart the coding process or before resending a program from a file to the interpreter.

Format NEW

Parameters N/A



Example • This is an example of how to use the NEW command:

```
10 PRINT "Hello World"  
RUN  
Hello World  
  
LIST  
10 PRINT "Hello World"  
  
NEW  
LIST
```

Comments This is an interactive command that takes effect as soon as it is received by the printer.

REM

Description A numbered **remark** line starts with **REM** and includes text in any form after it. This line is ignored by the interpreter.

Format **REM** <comment>

Parameters The comment string can contain any character and is terminated by a carriage return.



Example • This is an example of how to use the **REM** command:

```
10 REM COMMAND LINES 20-100 PRINT A LABEL
```

Comments Remarks are used for program description and are included as a separate program line. To append a comment to the end of a program line, use the exclamation mark (!).

A useful method to keep comments in a stored file (but not in the printer) is to always start the **REM** line with the number 1. When all of the lines are sent to the printer, only the last **REM** line will stay resident in the printer. This will require less RAM for large programs.



Example • This is an example of how to re-use the **REM** command:

```
1 REM MYPROGRAM COPYRIGHT ME Inc. 2008
1 REM While debugging a port may be left open
5 CLOSE ALL
1 REM Open the ports this program will use
10 OPEN #0: NAME: "SER" ! Restart the console
```

! (EXCLAMATION MARK)

Description The exclamation mark is the marker for adding comments to the end of numbered programming lines. Any text following the ! is ignored when the line or command is processed.

Format !<comment>

Parameters The comment string can contain any character and is terminated by the carriage return.



Example • This is an example of how to use the ! (comments) command:

```
10 LET A=10 ! Indicates number of labels to print
```

Comments None

LIST

Description This command lists the program lines currently in memory.

Format

```
LIST  
LIST <A>  
LIST <A>-<B>
```

Parameters

default = lists all lines in memory
<A> = line to start listing the program
 = line to stop listing the program. If not specified, only the line at <A> will print.



Example • This is an example of how to use the LIST command:

```
1 REM MYPROGRAM COPYRIGHT ME Inc. 2008  
1 REM While debugging a port may be left open  
5 CLOSE ALL  
1 rem Open the ports this program will use  
10 OPEN #0: NAME: "SER" ! Restart the console  
20 PRINT #0: "Hello World"  
LIST  
1 REM Open the ports this program will use  
5 CLOSE ALL  
10 OPEN #0: NAME: "SER" ! Restart the console  
20 PRINT #0: "HeLlo World"  
  
LIST 1  
1 REM Open the ports this program will use  
  
LIST 5-10  
5 CLOSE ALL  
10 OPEN #0: NAME: "SER" ! Restart the console
```

Comments The output of the LIST command may not match exactly what was entered. It is based on how the program lines are stored in memory. Notice that the last comment line the REM is entered in lower case characters. When it is listed, the REM is displayed in uppercase.

This is an interactive command that takes effect as soon as it is received by the printer.

AUTONUM

Description This command automatically generates sequential program line numbers.

Format `AUTONUM <A>,`

Parameters

A = the number used to start the auto-numbering sequence

B = the automatic increment between the new line numbers

Example • This example shows specifying the starting line number in the increment between new line number. Type the following at the prompt:

```
AUTONUM 10,5
SUB START
PRINT "HELLO WORLD"
GOTO START

LIST
```

Will produce:

```
AUTONUM 10,5
10 SUB START
15 PRINT "HELLO WORLD"
20 GOTO START
```

The three lines are automatically started with the `AUTONUM` parameters; in this case, the first line starts with 10 and each subsequent line increments by 5.

Comments This feature is disabled by overwriting the current line number and entering the desired interactive mode commands, or leaving the line blank.

Use of the `SUB` command allows for `GOTO` and `GOSUB` statements that do not require line numbers in your program.

This is an interactive command that takes effect as soon as it is received by the printer.

RENUM

Description This command renumbers the lines of the program being edited. **RENUM** can reorganize code when line numbers become over- or under-spaced. The line references following **GOTO** and **GOSUB** statements are renumbered if they are constant numeric values. Renumbering does not occur if the line numbers are outside of the range limits of 1 to 10000.

Format **RENUM** <A>,

Parameters

<A> = the number to start the renumbering sequence

 = the automatic increment between the new line numbers



Example • This is an example of how to use the **RENUM** command:

```
LIST
13 LET A=6
15 LET B=10
17 GOTO 13
RENUM 10,5
LIST
10 LET A=6
15 LET B=10
20 GOTO 10
```



Note • The target of the **GOTO** command changes from 13 to 10 to reflect the renumbering.

Comments This is an interactive command that takes effect as soon as it is received by the printer.

ECHO

Description When Console Mode is enabled, this command controls whether the printer echoes the characters back to the communications port. If **ECHO ON** is entered, keystroke results return to the screen. If **ECHO OFF** is entered, keystroke results do not return to the screen.

Format

ECHO ON
ECHO OFF

Parameters

<ON/OFF> = toggles the ECHO command on or off

Example N/A

Comments This can be an interactive command that takes effect as soon as it is received by the printer, or a program command that is preceded by a line number.

Running and Debugging Commands

The following commands were written before the development of the ZBI-Developer application. With that application, and when using ZBI version 1, the following commands are essentially obsolete. However, for those who started developing ZBI applications before ZBI-Developer, the following reference will be helpful.

RUN – Starts executing the program currently in memory at the first line of the program

CTRL-C Sends an end-of-transmission character, **ETX**, to the console to terminate the ZBI program currently running.

RESTART – Starts executing the program currently in memory where it was last stopped

STEP – Executes one line of the program in memory where it was last stopped

DEBUG – This mode controls whether or not the **TRACE** and **BREAK** commands are processed

TRACE – Shows which lines have been executed and which variables have been changed

BREAK – Stops the currently running program

ADDBREAK – Adds a break to an existing line

DELBREAK – Deletes an existing break

ZPL Terminates and exits the ZBI environment.

This example shows many of the Running and Debug Commands in practice.

→ **Example • Preview:**

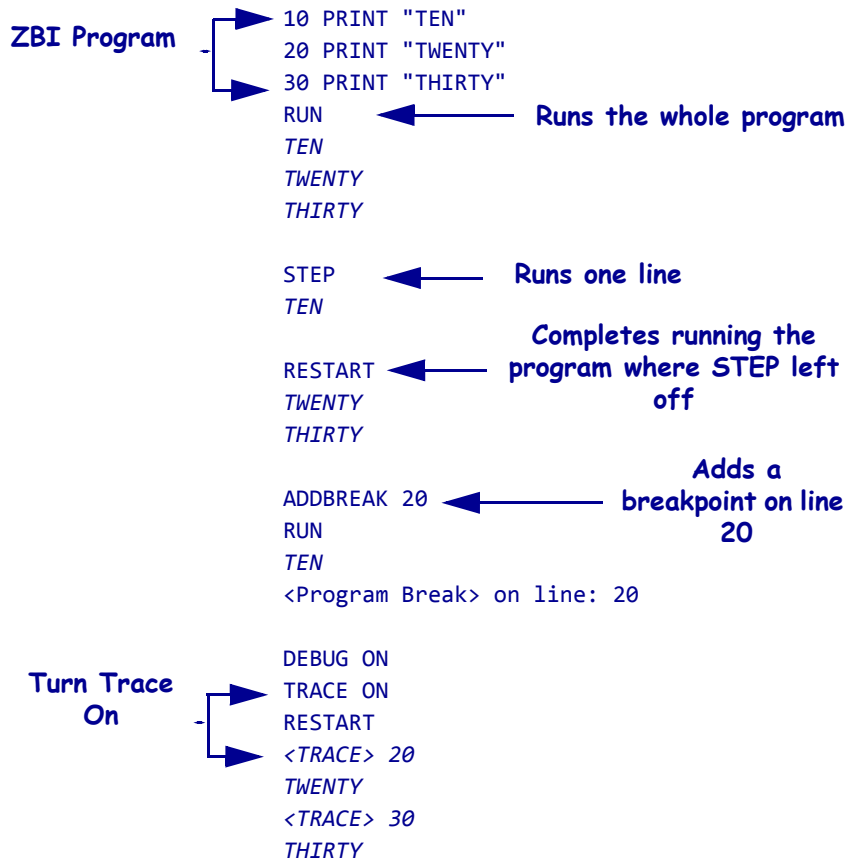

RUN

Description This command executes the current program, starting with the lowest line number. The interpreter will continue to execute the program lines in order unless a control statement directs the flow to a different point. When a higher line number does not exist or the END command is processed, the RUN command will stop.

Format RUN

Parameters N/A



Example • This is an example of how to use the RUN command:

```
10 PRINT "ZBI"  
20 PRINT "Programming"  
RUN  
ZBI  
Programming  
  
15 END  
RUN  
ZBI
```

Comments Ports that are open when the application is activated will remain open after the application has terminated. Variables also remain after the application has terminated.

To execute programs when the printer is powered on, use the ^JI command in the Autoexec.zpl file.

This is an interactive command that takes effect as soon as it is received by the printer.

CTRL-C

Description Sending an end-of-transmission character, **ETX** (3 in hex), to the console (port 0) terminates the ZBI program currently running.

Format N/A

Parameters N/A

Example N/A

Comments In most terminal programs, you terminate the program using the **Ctrl-C** key sequence. Another method is to store an ETX character in a file and have the terminal program send the file to the console port.



Note • It is not recommended to use **RESTART** after using a **CTRL-C** because a command may have been prematurely interrupted. Restarting will have an undefined result.

RESTART

Description If a program was halted by a break point or the **BREAK** command, the **RESTART** command can be used to reactivate the program at the point it stopped. **RESTART** functions similar to **RUN**, except the program attempts to restart from the point where it was last terminated. It also works in conjunction with the **STEP** command, picking up where the **STEP** command ended.

Format **RESTART**

Parameters N/A



Example • An example of the **RESTART** command:

```
10 PRINT "TEN"  
20 PRINT "TWENTY"  
30 PRINT "THIRTY"  
RUN  
TEN  
TWENTY  
THIRTY  
  
STEP  
TEN  
  
RESTART  
TWENTY  
THIRTY  
  
ADDBREAK 20  
RUN  
TEN  
<Program Break> on Line: 20  
  
DEBUG ON  
TRACE ON  
RESTART  
<TRACE> 20  
TWENTY  
<TRACE> 30  
THIRTY
```

Comments If the program has not been run or has finished, **RESTART** runs the program from the beginning.

This is an interactive command that takes effect as soon as it is received by the printer.

STEP

Description If a program was stopped by a **BREAK** command, **STEP** attempts to execute the program one line from where it last ended. If the program has not been run or has been completed, this executes the lowest numbered line.

Format **STEP**

Parameters N/A



Example • This is an example of how to use the **STEP** command:

```
10 PRINT "Hello World"  
20 Print "TWENTY"  
STEP  
Hello World  
  
STEP  
TWENTY
```

Comments This is an interactive command that takes effect as soon as it is received by the printer.

DEBUG

Description `DEBUG` enables and disables the `TRACE` and `BREAK` commands.

Format

```
DEBUG ON  
DEBUG OFF
```

Parameters

`ON` = turns the debug mode on enabling the `TRACE` and `BREAK` commands to be processed.

`OFF` = turns the debug mode off. This disables the `TRACE` mode and causes `BREAK` commands to be ignored.



Example • See *TRACE on page 483* and *BREAK on page 484*.

Comments This command has no effect on the processing of break points in ZBI-Developer. It is recommended that you avoid using the `DEBUG` command when writing programs in the ZBI-Developer environment, instead use the Debug capabilities of ZBI-Developer.

TRACE

Description This command enables you to debug an application by outputting the executed line numbers and changed variables to the console.

Format

```
TRACE ON  
TRACE OFF
```

Parameters

<ON/OFF> = controls whether **TRACE** is active (ON) or disabled (OFF).

If **DEBUG** is activated and the **TRACE** command is on, trace details are displayed. When any variables are changed, the new value displays as follows:

```
<TRACE> Variable = New Value
```

Every line processed has its line number printed as follows:

```
<TRACE> Line Number
```



Example • An example of **TRACE** command in use:

```
10 LET A=5  
20 GOTO 40  
30 PRINT "Error"  
40 PRINT A  
DEBUG ON  
TRACE ON  
RUN  
<TRACE> 10  
<TRACE> A=5  
<TRACE> 20  
<TRACE> 40  
5
```

Comments This can be an interactive command that takes effect as soon as it is received by the printer, or a program command that is preceded by a line number.

It is recommended that you avoid using the **TRACE** command when writing programs in the ZBI-Developer environment, instead use the Debug capabilities of ZBI-Developer.

BREAK

Description This command allows you to stop the program when the program reaches this line.

Format `BREAK`

Parameters N/A



Example • An example of BREAK command in use:

```
10 LET A=5
20 BREAK
30 PRINT A
DEBUG ON
TRACE ON
RUN
<TRACE> 10
<TRACE> A=5
<TRACE> 20
<USER BREAK>
```

Comments This command is available only when the `DEBUG` function has been activated. When `DEBUG` is on, `BREAK` halts processing. `RUN` starts the program from the beginning. `RESTART` allows the program to continue from where it left off.

When using ZBI-Developer, this command will interfere with the debugging operations built into the application.

This is a program command that must be preceded by a line number.

ADDBREAK



Description This command allows you to stop the program when the program reaches a specified line.

Format `ADDBREAK <A>`

Parameters

A = the line number to break on. If the number specified is not in the program, the program will not break.



Example • An example of the ADDBREAK command.

```
10 LET A=5
20 PRINT A
ADDBREAK 20
RUN
<PROGRAM BREAK> ON LINE:20

RESTART
5
```

Comments This command is available only when the `DEBUG` function has been activated. When `DEBUG` is on, `BREAK` halts processing. `RUN` starts the program from the beginning. `RESTART` allows the program to continue from where it left off.

This is the command used internally by ZBI-Developer when the user right-clicks over a program line and adds a Breakpoint via the "Toggle Breakpoint" selection.

It is the recommended method for setting breakpoints in ZBI.

A maximum of 16 breakpoints can be set in an application.

This is an interactive command that takes effect as soon as it is received by the printer.

DELBREAK



Description This command allows you to remove existing breakpoints.

Format DELBREAK <A>

Parameters A = the line number from which to remove the break. If 0 is specified, all break points will be removed. If the number specified is not a breakpoint, the command will have no effect.



Example • An example of the DELBREAK command:

```
10 LET A=5
20 PRINT A
ADDBREAK 20
DEBUG ON
TRACE ON
RUN
<TRACE> 10
<TRACE> A=5
<PROGRAM BREAK> ON LINE:20
```

```
RESTART
<TRACE> 20
5
```

```
DELBREAK 20
RUN
<TRACE> 10
<TRACE> A=5
<TRACE> 20
5
```

Comments This command is available only when the DEBUG function has been activated. When DEBUG is on, BREAK halts processing, RUN starts the program from the beginning, and RESTART allows the program to continue where it left off.

This is the command used internally by ZBI-Developer when the user right-clicks over a program line and removes a Breakpoint via the "Toggle Breakpoint" selection.

A maximum of 16 breakpoints can be set in an application.

This is an interactive command that takes effect as soon as it is received by the printer.

ZPL

Description This command terminates and exits the ZBI environment.

Format ZPL

Parameters N/A



Example • An example of the ZPL command.

```
ZPL  
ZBI TERMINATED
```

Comments This is an interactive command that takes effect as soon as it is received by the printer.

Base Types and Expressions

There are two base types in the ZBI language. These types are Integers and Strings. Integers are whole numbers that contain no fractional part. The range of values for integers is:

-2,147,483,648 to +2,147,483,647

Strings are character arrays. The string length is only limited by the amount of memory in the system (version 2.0 and higher). Each character can have a value between 0 and 255 (version 2.0 and higher).

The use of control characters (0-31) may be difficult to debug based on the handling of control characters in different communications programs. In addition the ETX (3) will terminate a ZBI application when it is received on the console port. Use the CHR\$ function when control characters must be placed into strings.



Note • In ZBI version 1.4 and lower, there was a string length limit of 255 characters.

This section is organized as follows:

- Variable Names
- Variable Declarations
- Constants
- Arrays
- Assignment
- Numeric Expressions
- String Concatenation (&)
- Sub-strings
- Boolean Expressions
- Combined Boolean Expressions

Variable Names

To distinguish strings from integers, string variable names must end in a \$. Variable names must start with a letter and can include any sequence of letters, digits, and underscores. Function and command names must not be used as a variable name. Variable names are not case sensitive and are converted to uppercase by the interpreter.

A common mistake is to use a command or function name as a variable. To avoid using these reserved words, ZBI-Developer can be a useful resource. Reserved words are highlighted making it easier to spot this occurrence and thus, saving debugging time.

Valid variable names:

I, J, K, VARNAME, VARSTR\$, MYSTR\$,MY_STR9\$

Invalid Names:

STR\$ = Reserved word

ORD = Reserved word

VAL = Reserved word

W# = Invalid character (#)

9THSTR = Variable can not start with a number

Variable Declarations

ZBI will allow storage of up to 255 variables. If more variables are needed, consider using arrays to store data. The base array will take up one of the 255 variable slots, but it can be declared to allow for many indices.

Variables can be declared explicitly or implicitly. If a variable has not been used before, it will be declared when used. The default value for an integer will be zero and the default value of a string will be an empty string.

Explicit:

```
DECLARE NUMERIC <variable_name>  
DECLARE STRING <variable_name$>
```

If the variable existed before the DECLARE statement, it will be defaulted.

Implicit:

```
LET <variable_name> = NUMERIC EXPRESSION  
LET <variable_name$> = STRING EXPRESSION
```

The Interpreter is limited to 255 variables. If more variables are required, consider using arrays.

Constants

Integers are represented simply by numbers, such as 5, -10, 10000. Do not use commas in integer constants. Strings are enclosed by quotes. If a quote is required in the string, use double quotes, such as “Look here->””<-“ would result in the string – Look here->”<-.

Arrays

An array is a collection of string or integer values used by a program. Array indices are accessed through parentheses. Array indices start at 1 and end at the length of an array (for example, MyArray(3) returns the value in the third location of the variable array). One- and two-dimensional arrays are allowed. Two-dimensional arrays are referenced with two indices in parentheses, separated by a comma.

Arrays must be allocated through the use of the **DECLARE** command. Arrays can be re-dimensioned by using **DECLARE**, however, this will replace the original array.

Array size is limited only by the size of the memory available.

Format

```
DECLARE STRING <ARRAYNAME$>(<SIZE>)  
DECLARE STRING <ARRAYNAME$>(<ROWS>,<COLUMNS>)  
DECLARE NUMERIC <ARRAYNAME>(<SIZE>)  
DECLARE NUMERIC <ARRAYNAME>(<ROWS>,<COLUMNS>)
```

Parameters

<SIZE> = number of entries in a single dimension array

<ROWS> = number of rows in a two dimensional array

<COLUMNS> = number of columns in a two dimensional array



Example • An example of ARRAY code is:

```
10 DECLARE STRING INARRAY$(3)
20 FOR I = 1 TO 3
30 PRINT "Name "; I; ": ";
40 INPUT INARRAY$(I)
50 NEXT I
60 PRINT INARRAY$(1); ", "; INARRAY$(2); ", and "; INARRAY$(3);
70 PRINT " went to the park"
RUN
Name 1: Jim
Name 2: Jose
Name 3: Jack
Jim, Jose, and Jack went to the park
```

Comments If you attempt to access an array outside of its allocated bounds, an error will occur.

Assignment

All lines must start with a command. In order to assign a value to a variable, use the LET command. Multiple variables can be placed before the =. The variable types must match the expression type.

The right side of the assignment is always calculated completely before the assignment is made. This allows a variable to be the target and source of the assignment.

When a value is assigned to a string variable with a sub-string qualifier, it replaces the value of the sub-string qualifier. The length of the value of the string variable may change as a result of this replacement.



Example • An ASSIGNMENT example:

```
10 LET A=5  
20 LET B$="HELLO"  
30 LET B$(5:5)=B$
```

LET

Description The LET command is used to assign value to a specific variable. The expression is evaluated and assigned to each variable in the variable list. See *Assignment on page 493*.

Format

```
LET <variable> [,<variable>]* = <expression>
```

The variable types must match the expression type or an error message will be displayed.

Error: Poorly formed expression.

When a value is assigned to a string variable with a sub-string qualifier, it replaces the value of the sub-string qualifier. The length of the value of the string variable may change as a result of this replacement.

Parameters N/A



Example • This is an example of how to use the LET command:

```
10 LET A$= "1234"  
15 LET A$(2:3)= "55" ! A$ NOW = 1554  
20 LET A$(2:3)= "" ! A$ NOW = 14  
  
10 LET A$= "1234"  
15 LET A$(2:3)= A$(1:2) ! A$ NOW = 1124  
  
10 LET A$= "1234"  
15 LET A$(2:1)= "5" ! A$ NOW = 15234
```

Comments This can be an interactive command that takes effect as soon as it is received by the printer, or a program command that is preceded by a line number.

Numeric Expressions

A base numerical expression can be either a constant, variable, or another numerical expression enclosed in parentheses. The five types used (addition, subtraction, multiplication, division, and exponentiation) are listed below. When evaluating an expression exceeding the maximum or minimum values at any point creates an undefined result. (maximum value: 2,147,487,647; minimum value: -2,147,483,648)

Floating point is not supported.

When using division, the number is always rounded down. For example, $5/2=2$. Use `MOD` to determine the remainder.

Format

1. + (addition) Addition expressions use this format:

`<A>+`

5+2 result = 7

VAL ("25") +2 result =27

2. - (subtraction) Subtraction expressions use this format:

`<A>-`

5-2 result = 3

VAL ("25") -2 result =23

3. * (multiplication) Multiplication expressions use this format:

`<A>*`

5*2 result = 10

VAL ("25") *2 result =50

4. / (division) Division expressions use this format:

`<A>/`

5/2 result = 2

VAL ("25") /2 result =12

5. ^ (exponentiation) Exponentiation expressions use this format:

`<A>^`

5^2 result = 25

VAL ("25") ^2 result =625

Order of Precedence

In mathematics, the order of precedence describes the sequence that items in an expression are processed. All expressions have a predefined order of precedence.

The order of precedence is listed below:

Functions
Parenthetical Expressions ()
^
* and /
+ and -

The * and / have the same precedence, and the + and - have the same precedence. Items with the same order of precedence are processed from left to right.

For example, this expression $5+(8+2)/5$ is processed as $8+2=10$, followed by $10/5=2$, then $5+2$ to give a result of 7.

Functions and parenthetical expressions always have the highest order of precedence, meaning that they are processed first.

String Concatenation (&)

The basic string expression may be either a constant or a variable, and concatenation (&) is supported. Using the concatenation operator (&) adds the second string to the first string.

`<A$> & <B$>`



Example • This is an example of how to use the `STRING CONCATENATION (&)` command:

```
10 LET A$= "ZBI-"
20 LET B$= "Programming"
30 LET C$= A$ & B$
40 PRINT C$
RUN
ZBI-Programming
```

Sub-strings

Description Using a sub-string operator on a string allows a specific portion of the string to be accessed. This portion may be the target of an assignment operation or a reference to a portion of the string. To determine the coordinates of the string portion to be used, count the characters from the beginning to the end of the string, including spaces.

Format

```
LET <STRVAR$>(<A>:<B>)=<C$>
LET <C$> = <STRVAR$>(<A>:<B>)
```

Parameters

`<A>` = the position of the first character in the desired string

`` = the position of the last character in the desired string.

`<STRVAR$>` = base string variable

If the `A` parameter is less than 1, it is automatically assigned a value of 1. Because the string is calculated starting with 1, the `A` parameter cannot be less than 1.

If `B` is greater than the length of the string, it is replaced with the length of the string.

If `A` is greater than `B`, a NULL string (" "), which points to the location of the smaller of `A` or the end of the string, is returned. This is used when adding a string in the middle of another string without removing a character.



Example • This is an example of a sub-string reference:

```
LET A$="Zebra Quality Printers"  
LET B$=A$(1:13)  
PRINT B$  
Zebra Quality
```

Example • This is an example of a sub-string assignment.

```
LET A$= "1234"  
LET A$(2:3)= "55" ! A$ NOW = 1554  
LET A$(2:3)= "" ! A$ NOW = 14  
  
LET A$= "1234"  
LET A$(2:3)= A$(1:2) ! A$ NOW = 1124  
  
LET A$= "1234"  
LET A$(2:1)= "5" ! A$ NOW = 15234
```

The best way to think of assignment to a sub-string is as follows: an assignment is like selecting a word, and pasting over the selection with the new string.

Boolean Expressions

Description A Boolean expression holds 0 (zero) as false and non-zero as true.

Formats

<STRING EXPRESSION> <BOOLEAN COMPARE> <STRING EXPRESSION>
<NUMERIC EXPRESSION> <BOOLEAN COMPARE> <NUMERIC EXPRESSION>
NOT(<BOOLEAN EXPRESSION>)

Parameters

<STRING EXPRESSION> = a string variable, string constant or any combination with concatenation

<NUMERIC EXPRESSION> = any mathematical operation

Comments A numeric expression cannot be compared to a string expression.

Numeric expressions can substitute a Boolean expression where a value of 0 (zero) represents false and a non-zero value represents true.

Base Boolean expressions:

1. < (less than)

Expression	Result
1 < 2	true
2 < 2	false
2 < 1	false

2. <= (less than or equal to)

Expression	Result
1 <= 2	true
2 <= 2	true
2 <= 1	false

3. > (greater than)

Expression	Result
1 > 2	false
2 > 2	false
2 > 1	true

4. >= (greater than or equal to)

Expression	Result
1 >= 2	false

Expression	Result
2>=2	true
2>=1	true

5. = (equal to)

Expression	Result
1=2	false
2=2	true
"A"="AA"	false
"A"="A"	true

6. <> (not equal to)

Expression	Result
1<>2	true
2<>2	false
"A"<>"AA"	true
"A"<>"A"	false

Combined Boolean Expressions

AND, OR, and NOT can be used in conjunction with base Boolean expressions to recreate expanded Boolean expressions.

1. NOT — Negate the target expression.

Expression	Result
NOT 1=2	true
NOT 1=1	false

2. AND — Both expressions must be true for a true result.

Expression	Result
1=2 AND 1=2	false
2=2 AND 1=2	false
1=2 AND 2=2	false
2=2 AND 2=2	true

3. OR — If either expression is true, the result will be true.

Expression	Result
1=2 OR 1=2	false
1=2 OR 2=2	true
2=2 OR 1=2	true
2=2 OR 2=2	true

Order of Precedence

The order of precedence is listed below:

Expressions and Functions
Paranetical expressions ()
<, <=, <>, =, =>, >
NOT, AND, OR

Control and Flow

This section outlines the commands to conditionally execute code and control the flow of the program. Here is a quick list of these commands:

IF Statements Executes or skips a sequence of statements, depending on the value of a Boolean expression.

DO Loops Repeats instructions based on the results of a comparison.

FOR Loops A control flow statement which allows code to be executed iteratively.

GOTO/GOSUB Causes an unconditional jump or transfer of control from one point in a program to another.

SUB Allows you to “substitute” names instead of actual line numbers as the target of **GOSUBS** and **GOTOS**.

EXIT Used to exit the **DO** and **FOR** loops.

END Terminates any program currently running.

IF Statements

Description If the value of the <Boolean expression> in an IF statement is true and a program line follows the keyword **THEN**, this program line is executed. If the value of the Boolean expression is false and a program line follows the keyword **ELSE**, this program line is executed. If **ELSE** is not present, then execution continues in sequence, with the line following the **END IF** statement.

Nesting of blocks is permitted, subject to the same nesting constraints as **DO-LOOPS** (no overlapping blocks).

ELSE IF statements are treated as an **ELSE** line followed by an **IF** line, with the exception that the **ELSE IF** shares the **END IF** line of the original **IF** statement.

Format

```
IF <Boolean expression> THEN
~~BODY~~
[ELSE IF <Boolean expression> THEN
~~BODY~~]*
[ELSE
~~BODY~~]
END IF
```

Parameters N/A



Example • This is an example of how to use the IF statement command:

```
10 IF A$="0" THEN
20 PRINT "ZBI IS FUN"
30 ELSE IF A$="1" THEN
40 PRINT "ZBI IS EASY"
50 ELSE IF TIME=1 THEN
60 PRINT "It is one second past midnight"
70 ELSE
80 PRINT "X=0"
90 END IF
```

DO Loops

Description Processing of the loop is controlled by a <WHILE/UNTIL> expression located on the DO or LOOP line.

Processing a WHILE statement is the same on either the DO or LOOP lines. The Boolean expression is evaluated and if the statement is true, the LOOP continues at the line after the DO statement. Otherwise, the line after the corresponding LOOP is the next line to be processed.

Processing an UNTIL statement is the same on either the DO or LOOP lines. The Boolean expression is evaluated and if the statement is false, the LOOP continues at the line after the DO statement. Otherwise, the line after the corresponding LOOP is the next to be processed.

If <WHILE/UNTIL> is on the LOOP line, the BODY of the loop is executed before the Boolean expression is evaluated.

If neither the DO or LOOP line has a <WHILE/UNTIL> statement, the loop continues indefinitely.

Some notes about DO-LOOPS:

- can be nested
- cannot overlap
- have two formats

Format

```
DO [<WHILE/UNTIL> <Boolean expression>]
~~BODY~~
LOOP [<WHILE/UNTIL> <Boolean expression>]
```



Example • This is an example of how to use the DO-LOOP command with the conditional on the DO line:

```
10 DO WHILE A$="70"
20 INPUT A$
30 LOOP
```



Example • This is an example of how to use the DO UNTIL LOOP command with conditional on the LOOP line:

```
10 DO
20 INPUT A$
30 LOOP UNTIL A$="EXIT"
```

Comments This is a program command that is preceded by a line number.

FOR Loops

Description FOR loops are an easy way to iterate through a range of values and run a body of code for each value iterated.

Format

```
FOR <I> = <A> TO <B> [STEP <C>]
  ~~BODY~~
NEXT <I>
```

Parameters

<I> = indicates a numeric variable is used. <I> increments each time through the FOR-LOOP.

<A> = the value assigned to <I> the first time through the loop

 = the last value through the loop

<C> = (Optional) the amount <I> increments each time through the loop

Values of I for the following situations:

Statement	Result
FOR I=1 TO 10	{1, 2, 3, 4, 5, 6, 7, 8, 9, 10}
FOR I=10 TO 1	{10, 9, 8, 7, 6, 5, 4, 3, 2, 1}
FOR I=1 TO 10 STEP 2	{1, 3, 5, 7, 9}
FOR I=10 TO 1 STEP 2	{10, 8, 6, 4, 2}
FOR I=10 TO 1 STEP 2	{ } FOR LOOP skipped



Example • This is an example of how to use the FOR LOOP command:

```
10 FOR X=1 TO 10 STEP 1
20 PRINT X; ":ZBI IS FUN"
30 NEXT X
```

Comments FOR loops can be nested but cannot overlap. Variables cannot be reused by the nested loops.

GOTO/GOSUB

Description `GOSUB` is followed by a line number. The program will attempt to process the line the `GOSUB` command points to rather than the next line of the program. Upon executing the `GOSUB` statement, the interpreter continues running at the line number specified following `GOSUB`. If the line number referenced does not exist, an error will occur.

Before executing the next line, the `GOSUB` command stores the line number of the `GOSUB` line. When the `RETURN` statement is called, the program moves back to the next line following the `GOSUB`.

Executing a `RETURN` statement without a corresponding `GOSUB` statement causes an error.

`GOSUB` statements can be nested.

`GOTO` works the same way as `GOSUB` except that no return address will be stored.

Format

```
GOSUB <A>
RETURN
GOTO <A>
```

Parameters `<A>` = the program location executed immediately after the `GOTO` or `GOSUB`.



Example • This is an example of how to use the `GOSUB` command:

```
10 PRINT "Call Subroutine"
20 GOSUB 1000
30 PRINT "Returned from Subroutine"
40 END
1000 PRINT "In Subroutine"
1010 RETURN
```

Example • This is an example of how to use the `GOTO` command:

```
10 PRINT "Prepare to Jump!"
20 GOTO 1000
30 PRINT "Jump Missed..."
1000 PRINT "Jump Successful"
1010 END
```

Comments These are program commands and must be preceded by line numbers.

SUB



Description This command allows you to use names instead of actual line numbers as the target of `GOSUBS` and `GOTOS`. `AUTONUM` can be used at the beginning of a file and there is no need to compute the line number where the jump will go.

Format `10 SUB <A>`

Parameters `<A>` = the integer variable to use as a target for the `GOTO/GOSUB`



Example • This is an example of how to use the `SUB` command:

```
AUTONUM 1,1
GOSUB INITCOMM
DO
GOSUB GETINPUT
GOSUB PROCESSINPUT
LOOP
SUB INITCOMM
OPEN #1:NAME "SER"
RETURN
SUB GETINPUT
INPUT #1: A$
RETURN
SUB PROCESSINPUT
PRINT A$
RETURN
```

Comments `<A>` is a numeric variable. If this variable is changed in the program, any `GOSUB/GOTO` to this variable may fail.

EXIT

Description This command is used to exit the `DO` and `FOR` loops.

Format

```
EXIT DO  
EXIT FOR
```

Parameters The specified loop type is exited. For the `DO` command, the program will continue execution on the line following the next `LOOP`. Likewise for the `FOR` command, the program will continue on the line after the next `NEXT` command.

Example N/A

Comments This is a program command that is preceded by a line number. To be explicit and reduce errors, it is recommended to use `GOTO` instead of `EXIT`.

END

Description The `END` command terminates any program currently running. When the `END` command is received, the interpreter returns to interpreting commands (`>`).

Format `END`

Parameters N/A



Example • This is an example of how to use the `END` command:

```
10 PRINT "THIS PROGRAM WILL TERMINATE"  
20 PRINT "WHEN THE END COMMAND IS RECEIVED"  
30 END  
40 PRINT "THIS SHOULD NOT PRINT"  
RUN  
THIS PROGRAM WILL TERMINATE  
WHEN THE END COMMAND IS RECEIVED
```

Comments This is a program command and is preceded by a line number.

Input and Output

This section outlines how to communicate with physical ports, internal ports, and the network.

ZBI allows access to the physical and network connections in the printer. Most ports are, by default, connected to the ZPL processor. When a port is opened in ZBI, the port will be disconnected from ZPL and connected into the interpreter. Depending on the type of connection, there are two methods you may use to start the connection. For the static connections, the **OPEN** command should be used. These are the connections that you open when starting your program and leave open for the duration of your program. For dynamic connections, servers and clients are set up following the "Sockets" model. On servers, the actual connections are started upon successful calls to **ACCEPT**. Below are the available connections that can be made and the preferred accessors.

Available Ports

Port/Connection	ZBI Name	Preferred Access Commands/Functions
Serial	"SER"	OPEN, CLOSE
Parallel	"PAR"	OPEN, CLOSE
USB	"USB"	OPEN, CLOSE
ZPL parser	"ZPL"	OPEN, CLOSE
TCP Server	"TCP", "TCPX"	SERVERSOCKET, SERVERCLOSE, ACCEPT, CLOSE
TCP Client	"TCP"	CLIENTSOCKET, CLOSE
UDP Server	"UDP"	SERVERSOCKET, SERVERCLOSE, ACCEPT, CLOSE
UDP Client	"UDP"	CLIENTSOCKET, CLOSE
Email Sender	"EML"	OPEN, CLOSE
Bluetooth	"BLU"	OPEN, CLOSE

Note: TCPx will not work on PS2 or PS100 print servers.

Creating Connections

Here is a quick list of the commands in this section:

OPEN Opens a port for transmitting and receiving data.

CLOSE Closes specific ports that are in use.

DATAREADY Determines if there is data received on a specified port.

SERVERSOCKET Opens a listening socket for incoming UDP packets or TCP connections.

SERVERCLOSE Closes a listening server socket.

CLIENTSOCKET Creates an outgoing TCP connection or sets up UDP transmissions.

ACCEPT Accepts incoming TCP or UDP connections and assigns a channel for the connection.

OPEN

Description This command is used to open a port for transmitting and receiving data.

Format OPEN #<CHANNEL>: NAME <PORT\$>

Parameters

<CHANNEL> = a number to use as a handle to the port for all future communications

Accepted Values: 0 to 9

Default Value: a port must be specified

<PORT\$> = port name to open. See *Available Ports on page 511*.



Example • This is an example of how to use the OPEN command:

```
10 OPEN #1: NAME "ZPL"
```

The port being opened no longer allows data to pass directly into its buffer, it disconnects, and the interpreter now controls the data flow.

Data already in the buffer stays in the buffer.

Comments This can be an interactive command that takes effect as soon as it is received by the printer, or a program command that is preceded by a line number.

CLOSE

Description This command is implemented to close specific ports that are in use. If a port is open on a channel and the **CLOSE** command is entered, the port closes and returns to communicating with the ZPL buffer.

Format

CLOSE #<A>

CLOSE ALL

Parameters

<A> = Numeric value of port to close

Accepted Values: 0 through 9

ALL = closes all open ports and network connections



Note • **CLOSE** ALL will close the console.



Example • This example shows the closing of channel 1:

```
10 CLOSE #1
```

Comments This can be an interactive command that takes effect as soon as it is received by the printer, or a program command that is preceded by a line number.

DATAREADY

Description This function is used to determine if there is data received on a specified port.

Format DATAREADY (A)

Parameters A = the port to check

Returns 1 if there is data, 0 if there is no data.



Example • This is an example of how to check if there is a data on a port:

```
10 PRINT DATAREADY(0)  
RUN
```

The result, assuming no data is waiting, is:

```
0
```

Comments If this command follows the **INPUT** command, it may return 1 if the line received was ended with a CRLF. In this case, **INBYTE** can be used to take the LF out of the buffer.

SERVERSOCKET



Description This function opens a listening socket for incoming UDP packets or TCP connections. It must be used in conjunction with the [ACCEPT](#) function.

Format `SERVERSOCKET (TYPE$,PORT)`

Parameters

`TYPE$` = listens for any of the following communication protocols:

"TCP" = TCP – PORT parameter is ignored. The current port will be used.

"TCPX" = TCP – any open port

"UDP" = UDP – any open port

Returns `NUMERIC` = returns the handle of the server upon success.



Example • See the examples for *TCP Server* [on page 529](#) and *UDP Server* [on page 531](#).

Comments When using `TCPX`, care needs to be taken not to use a port that is already open on the printer. No error message will be returned until the [ACCEPT](#) function is called.

SERVERCLOSE



Description This function closes a listening server socket created by SERVERSOCKET.

Format SERVERCLOSE(SOCKET)

Parameters

SOCKET = the socket handle returned from a successful SERVERSOCKET invocation.

Returns Returns a 0 if the socket was already closed or a 1 if the socket was closed successfully.



Example • This example shows how to close a listening server socket.

```
10 LET SERVER_HANDLE = SERVERSOCKET("TCPX", 19100)
20 LET SCERR = SERVERCLOSE(SERVER_HANDLE)
```

CLIENTSOCKET



Description This function creates an outgoing TCP connection or sets up UDP transmissions. Once set up for UDP, packets can be sent by printing to the socket. Packets are sent when the size limit is met or a **EOT** character is written.

Format CLIENTSOCKET (TYPE\$, IPADDR\$, PORT)

Parameters

TYPE\$ = set to "UDP" or "TCP".

IPADDR\$ = connects to this address.

PORT = connects to this IP port.

Returns The port number assigned to the connection.



Example • See the examples for *TCP Server on page 529* and *UDP Server on page 531*.

Comments Multiple communications connections can be made up to the maximum of 10. Each protocol may have a different limit based on the support of the print server used. Test the worst case situation based on your application's needs or use **ONERROR** to recover from failed connection attempts.

ACCEPT



Description This function will accept incoming TCP or UDP connections and assign a channel for the connection. `SERVERSOCKET` must be used to set up the listening socket before `ACCEPT` can be used.

Format `ACCEPT (SERVER, CLIENT_INFO$)`

Parameters

`SERVER` = the handle returned by the `SERVERSOCKET` call.

`CLIENT_INFO$` = string variable will have the connecting client's IP address and port separated by a space when using UDP.

Returns The channel number to use to communicate with the client.



Example • See the examples for *TCP Server on page 529* and *UDP Server on page 531*.

Comments It is best to poll this function at regular intervals. When there is no connection waiting, this function will trigger an error. Follow this function with the `ON ERROR` command to divert to a section of code that handles an unsuccessful connection.

`ACCEPT` can be called before closing a previous connection. This allows for processing multiple incoming streams of data. There are limits on the number of simultaneous incoming connections based on the print server model on the printer.

Connection closure can be detected when any input or output command to the port triggers an error. These commands should be followed by an `ON ERROR` statement to send the program into a recovery state and to shutdown the connection cleanly.

Reading and Writing

This manual has detailed various functions to read and write to all of the ports. The following section gives an overview of the commands, functions, and when each should be used.

To start, it is important to understand the term "blocking". In communications code, a function or command is "blocking" if it waits for all of the requested data to be received before it returns.

INPUT (blocking) Reads one line into each string specified.

PRINT (blocking) Simple method to write specified expressions out.

OUTBYTE (blocking) Writes one byte out.

INBYTE (blocking) Reads in one byte.

READ (non-blocking) Reads in all available data up to the maximum amount specified.

WRITE (non-blocking) Writes out as much data as possible up to a maximum specified amount.

SEARCHTO\$ (blocking) Reads in data (does not keep) until a search parameter is found. Non-matching data can be redirected to another port.

INPUT

Description If the variable is numeric and the value entered cannot be converted to a number, it writes as 0. This operation scans the data from left to right, shifting any number into the variable. It ignores any non-numeric character except the return character, which terminates the input, or Ctrl-C (^C) which terminates the program. The variable can be in string or numeric form.

Format

```
INPUT [<CHANNEL>:] <A$> [,<B$>]*
INPUT [<CHANNEL>:] <A>[,<B>]*
```

If the [<channel>:] is omitted, the default port, 0, will be used.

Parameters

<CHANNEL> = read data from this port. Default = 0.

<A,B,...,N> = variables to write.

When using multiple variables as targets, a corresponding number of lines are read. String and numeric variables can be intermixed.



Example • This is an example of how to use the INPUT command:

```
10 OPEN #1: NAME "ZPL"
20 PRINT #1: "~HS"
30 FOR I = 1 TO 3
40 INPUT #1: A$
50 PRINT A$
60 NEXT I
```

In this example, a host status prints to the console after submitting the host status request ~HS to the ZPL port. The Input/Output command of the ZBI interpreter is limited to the communications ports. File I/O is not supported.

INPUT ends processing a line with a CR or LF. This leads to a tricky situation. There are many ways different systems end a line: CR, CRLF, LF. If the ZBI program only uses INPUT, the next execution of the INPUT command will remove the extra LF or CR, in case of LFCR. However, if the program instead uses INBYTE, DATAREADY or the other commands, the extra LF will show up on the port. Here's a simple workaround to explicitly look for the CRLF that is in use:

```
SEARCHTO(<PORT>,<CHR$(13)&CHR$(10)>,<INSTRING$>)
```



Note • The INPUT command does not accept control characters or the delete character. If these characters need to be processed, please use the READ command.

Comments This can be an interactive command that takes effect as soon as it is received by the printer, or a program command that is preceded by a line number.

If an invalid port is specified, **Error: Invalid port** is returned.



Example • This shows the input command reading in multiple lines.

```
10 INPUT A$,B,C,D$,E$
Five lines would be read in: 3 strings and 2 numbers.
```

PRINT

Description This command sends data to the printer to be printed.

Format PRINT [CHANNEL:] <expression> [,or; <expression>]* [;]

Parameters

<CHANNEL> = write data to this port

<expression> = the value to write

The expression can be either a string or a numeric expression.

Using a , to separate expressions adds a space between them.

Using a ; to separate expressions does not put a space between them.

Using a ; at the end of a line ends the print statement without adding a new line (CR/LF).



Example • This is an example of how to use the PRINT command:

```
10 LET A$ = "This is an example"  
20 LET B$ = "of the PRINT Command."  
30 PRINT A$, B$ ! adds a space between expressions  
40 PRINT A$; B$ ! no space added  
RUN
```

The result is:

This is an example of the PRINT Command.

This is an exampleof the PRINT Command.

Comments This can be an interactive command that takes effect as soon as it is received by the printer, or a program command that is preceded by a line number.

OUTBYTE

Description This command outputs a byte to a port.

Format

```
OUTBYTE [<CHANNEL>:] <A>  
OUTBYTE [<CHANNEL>:] <A$>
```

Parameters

<CHANNEL> = sends the byte to this port. Default = 0.

<A> = This is a numeric expression.

Accepted Values: 0 through 255. If it is not within that range, it is truncated.

<A\$> = This is the string expression. The first character is used. In the case of a NULL string, 0 is sent.



Example • This is an example of how to use the OUTBYTE command:

```
LET A$="Hello"  
OUTBYTE A$
```

This would only print the H character to the console.

```
OUTBYTE 4
```

This would print the control character [EOT](#) to the console. See an ASCII table for a list of the control characters.

Comments This can be an interactive command that takes effect as soon as it is received by the printer, or a program command that is preceded by a line number.

INBYTE

Description This command forces the interpreter to pause until data is available. Use the `DATAREADY` function to determine if there is data on the port.

Format

```
INBYTE [<CHANNEL>:] <A>  
INBYTE [<CHANNEL>:] <A$>
```

Parameters

<CHANNEL> = reads from this port. Default = 0.

<A> = integer value is set to the byte received.

<A\$> = A single byte string is created with the byte received. The first character is used. In the case of a NULL string, 0 is sent.



Example • This is an example of how to use the `INBYTE` to create an echo program:

```
10 INBYTE A$ !Takes one byte (char) from port #0  
20 PRINT A$ !Prints the character to the console  
30 GOTO 10
```

In this example, the interpreter pauses until the data is entered, then continues processing. This command enters all bytes in a string or integer, including control codes.

Comments `INBYTE` will block until a byte is received on the specified port. This can be an interactive command that takes effect as soon as it is received by the printer, or a program command that is preceded by a line number.

READ



Description This is a non-blocking input function. It will read in all of the bytes available on the specified port.

Format READ (<CHANNEL>, <A>, <MAXBYTES>)

Parameters

- <CHANNEL> = reads from this port. Default = 0.
- <A\$> = the string where the data will be placed
- <MAXBYTES> = the maximum number of bytes to read

Returns The number of bytes read.



Example • This is an example of the READ command:

```
1 CLOSE ALL
2 LET INPORT = CLIENTSOCKET("TCP", "192.168.0.1", 9100)
3 ON ERROR GOTO RECOVERY
4 LET WATERMARK = 5000
5 DO WHILE 1
6 IF LEN(DATA$) < WATERMARK THEN
7 LET BYTESREAD = READ(INPORT, DATA$, 500)
8 ON ERROR GOTO RECOVERY
9 END IF
10 IF (LEN(DATA$) > 0) THEN
11 LET BYTES_WRITTEN = WRITE(INPORT, DATA$, LEN(DATA$))
12 ON ERROR GOTO RECOVERY
13 LET DATA$(1, BYTES_WRITTEN) = ""
14 END IF
15 IF BYTESREAD = 0 AND BYTESWRITTEN = 0 THEN
16 SLEEP 1 ! DON'T BOMBARD IF IDLE
17 END IF
18 LOOP
19 SUB RECOVERY
20 CLOSE #INPORT
```

WRITE



Description This is a non-blocking output function. It will write as many bytes as the output buffer can hold.

Format WRITE (<CHANNEL>, <A>, <BYTES>)

Parameters

<CHANNEL> = reads from this port. Default = 0.

<A\$> = the string to write out.

<MAXBYTES> = The number of bytes to write

Returns The number of bytes written.



Example • This is an example of WRITE command:

```
1 CLOSE ALL
2 LET INPORT = CLIENTSOCKET("TCP", "192.168.0.1", 9100)
3 ON ERROR GOTO RECOVERY
4 LET WATERMARK = 5000
5 DO WHILE 1
6 IF LEN(DATA$) < WATERMARK THEN
7 LET BYTESREAD = READ(INPORT, DATA$, 500)
8 ON ERROR GOTO RECOVERY
9 END IF
10 IF (LEN(DATA$) > 0) THEN
11 LET BYTES_WRITTEN = WRITE(INPORT, DATA$, LEN(DATA$))
12 ON ERROR GOTO RECOVERY
13 LET DATA$(1, BYTES_WRITTEN) = ""
14 END IF
15 IF BYTESREAD = 0 AND BYTESWRITTEN = 0 THEN
16 SLEEP 1 ! DON'T BOMBARD IF IDLE
17 END IF
18 LOOP
19 SUB RECOVERY
20 CLOSE #INPORT
```

SEARCHTO\$

Description This function performs a search until a specified string is found. The string the search yields is displayed.

Format

```
SEARCHTO$(A,B$)  
SEARCHTO$(A,B$,C)  
SEARCHTO$(A$,B$)  
SEARCHTO$(A$,B$,C$)
```

Parameters

A = port number (0 to 9) to which requested data is sent

A\$ = string to search for B\$

B\$ = string variable or string array. If B\$ is an array, this command searches for all non-null strings in the B\$ array.

C = a port in which the input is directed until B\$ is found

C\$ = a string in which the characters in A\$ are directed until B\$ is found

Returns The string found.



Example • This example shows how to use `SEARCHTO` to find a string on a port:

```
10 OPEN #1: NAME "SER"  
20 LET A$ = SEARCHTO$(1,"^XA")  
30 PRINT "FOUND:", A$
```



Example • This example shows how to search for an array of strings:

```
10 OPEN #1: NAME "SER"  
20 DECLARE STRING FIND$(3)  
30 LET FIND$(1) = "ONE"  
40 LET FIND$(2) = "TWO"  
50 LET FIND$(3) = "THREE"  
60 LET A$ = SEARCHTO$(1,FIND$)  
70 PRINT "FOUND:", A$
```



Example • This example shows unused data routed to a port.

```
10 OPEN #1: NAME "PAR"  
20 OPEN #2: NAME "SER"  
30 DECLARE STRING FIND$(3)  
40 LET FIND$(1) = "ONE"  
50 LET FIND$(2) = "TWO"  
60 LET FIND$(3) = "THREE"  
70 LET A$ = SEARCHTO$(1,FIND$,2)  
80 PRINT "FOUND:", A$
```



Example • This example shows how to use `SEARCHTO` to find a string within a string and direct the unused part of the string to another string:

```
10 LET A$ = "The faster you go, the shorter you are - Einstein"  
20 LET B$ = SEARCHTO$(A$,"you", C$)  
30 PRINT "FOUND:", B$  
40 PRINT "DISCARDED:", C$
```

Comments `SEARCHTO` will block (wait) until the search string is found. If you want to be able to run other code while doing something similar, consider using `READ` with `POS`.

When using `SEARCHTO` with ports, it will block (wait) until the search string is found. If you want to be able to run other code while doing something similar, consider using `READ` to place data into a string. That string can be passed to `SEARCHTO` for processing.

Port Usage Examples

Before diving into the syntax of all the commands, let's look at some simple applications using the different features of the communications systems in ZBI.

Physical Ports (Serial, Parallel, USB, Bluetooth®)

Though the types of devices interacting with the printer's ports may vary greatly, internal to the printer, the ports are all handled in the same way. These ports are opened with the ZBI `OPEN` command and closed with the ZBI `CLOSE` command. When one of these ports is opened, it is disconnected from the ZPL parser and any data in the buffer will be redirected to the ZBI environment.



Example • In the following example, "SER" could be replaced by "PAR", "USB", or "BLU" depending on the application.

```
10 CLOSE ALL
20 LET INPORT = 1
25 SLEEP 1
30 OPEN #INPORT: NAME "SER"
35 ON ERROR GOTO 25
40 PRINT #INPORT: "Enter your name:";
50 INPUT #INPORT: YOURNAME$
55 ON ERROR GOTO 70
60 PRINT #INPORT: "You entered: "; YOURNAME$
70 CLOSE #INPORT
```

ZPL Parser

To make a ZBI program print, it is necessary to create a connection from the program to the ZPL parser on the printer. The connection will function in the same way as a connection to a physical port, except that the connection will not automatically terminate. The ZPL parser in the printer can handle many incoming connections simultaneously. For example, a ZBI program could take control of the serial port and send label formats to the ZPL parser, while the parallel port (unopened by ZBI) could also be used to send label formats directly into the parser.



Note • The ZPL parser will lock onto one port once a format is started (via the `^XA` command). So, in some cases, is it desirable to start and stop your communications to ZPL in one continuous sequence.

Another use of ZBI is to check printer status, while another application prints to another port.



Example • Here is how that can be done:

```
10 OPEN #1: NAME "ZPL"
20 PRINT #1: "~HS"
30 FOR I = 1 TO 3
40 INPUT #1: A$
50 PRINT A$
60 NEXT I
```

TCP Client

There are two methods for making a TCP connection to another server. The first method uses the `OPEN` command while the second method uses the `CLIENTSOCKET` method.

`CLIENTSOCKET` is the preferred method.

→ **Example** • The following example demonstrates this method:

```
10 CLOSE ALL
20 LET INPORT = CLIENTSOCKET("TCP","192.168.0.1",9100)
40 LET OUTSTR$ = "REQUESTING SERVER NAME";
50 DO WHILE (LEN(OUTSTR$) > 0)
60 LET BYTES_WRITTEN = WRITE(INPORT,OUTSTR$,LEN(OUTSTR$))
70 ON ERROR GOTO RECOVERY
80 LET OUTSTR$ = OUTSTR$(1+BYTES_WRITTEN:LEN(OUTSTR$))
90 LOOP
100 INPUT #INPORT: YOURNAME$
110 PRINT #INPORT: "Server returned: "; YOURNAME$
120 CLOSE #INPORT
130 SUB RECOVERY
140 END
```

TCP Server

Setting up a listening server in the printer can be accomplished with the `SERVERSOCKET` function. To connect to incoming TCP sessions, use the `ACCEPT` function.

When starting the application, call `SERVERSOCKET`. This function will create a handle for this listening server. Check for incoming connections at regular intervals with the `ACCEPT` function. If there are no pending sessions, the `ACCEPT` function will return with an error. Handle the error using the `ON ERROR` command and continue looking for other sessions later.

Depending on how the program is set up, it is possible to handle one or more sessions at a time. If the program is configured to allow only one session, the other connections will remain pending until they are shut down by the requesting client or the ZBI program connects them.

→ **Example** • Here is an example of the `SERVERSOCKET` and `ACCEPT` commands:

```
10 CLOSE ALL
20 LET SERVER_HANDLE = SERVERSOCKET("TCPX",19100)
30 REM There are no connections yet we are just listening for them
40 REM Lets loop until we get a connection
50 SLEEP 1
60 LET INPORT = ACCEPT(SERVER_HANDLE,CLIENT_INFO$)
70 ON ERROR GOTO 50
80 PRINT #INPORT: "You have successfully connected!"
90 PRINT #INPORT: "Login:";
100 INPUT #INPORT: LOGIN$
110 PRINT #INPORT: "Password:";
120 INPUT #INPORT: PASSWORD$
130 REM We will not be nice and reject the connection
130 PRINT #INPORT: "Login failed"
140 CLOSE #INPORT
150 GOTO 60 ! Go look for the next connection
160 END
```

UDP Client

There are also two methods for making a UDP connection to another server. The first method uses the `OPEN` command, while the second method uses the `CLIENTSOCKET` method. UDP is a one way communication medium, thus, you can only use output commands. Because UDP is connectionless, the output will be queued up until an `EOT` character is written or the maximum packet size is exceeded. Once the `EOT` character is written, the packet is formatted and sent.

With UDP, it is important to be careful about understanding what the network being used will support.

In many cases, there will be a limit to the size of the packet that can be used, typically between 1000 and 1500 bytes, but some networks cut this down into the 500 to 600 byte range. To be safe, keep your packets less than 500 bytes.

UDP does not guarantee transmission. See UDP specifications for more details.



Example • Since `CLIENTSOCKET` is the preferred method, an example is shown below.

```
10 CLOSE ALL
20 LET INPORT = CLIENTSOCKET("UDP", "192.168.0.1", 22222)
30 LET EOT$ = CHR$(4)
40 PRINT #INPORT: "Packet #"; I; EOT$;
50 LET I = I + 1
60 SLEEP 1
70 GOTO 40
```

UDP Server

Setting up a listening server in the printer can be accomplished with the `SERVERSOCKET` function. Then, to connect to incoming UDP packets, use the function `ACCEPT`. When starting your application, call `SERVERSOCKET`. This function will create a handle for this listening server. Check for incoming packets at a regular interval with the `ACCEPT` function. If there are no pending sessions, the `ACCEPT` function will return with an error. Just handle the error using the `ON ERROR` command and continue looking for other sessions later. You will need to call `ACCEPT` for each incoming packet. When the accept is successful, all of the data will be available. Call `READ` with a `MAX` string size of 2000 and you will have the whole packet in your string. Close the port and wait for the next packet. You can only read in data using a UDP server.



Example • Here is an example of how to set up to receive UDP messages:

```
10 CLOSE ALL
20 LET ZPLPORT = 1
35 OPEN #ZPLPORT: NAME "ZPL"
40 LET SERVER_HANDLE = SERVERSOCKET("UDP",33333)
50 REM There are no connections yet: listening
60 REM Let's loop until we get a connection
70 SLEEP 1
80 LET INPORT = ACCEPT(SERVER_HANDLE,CLIENT_INFO$)
90 ON ERROR GOTO 70
100 LET PACKET_SIZE = READ(INPORT,PACKET$,2000)
110 PRINT #ZPLPORT: "^XA^F0100,100^A0N,40,40^FDPACKET FROM:";
115 PRINT #ZPLPORT: CLIENT_INFO$; "^FS"
120 PRINT #ZPLPORT: "^F0100,150^A0N,40,40^FDPACKET SIZE:";
125 PRINT #ZPLPORT: PACKET_SIZE; "^FS"
130 PRINT #ZPLPORT: "^F0100,200^A0N,40,40^FDPACKET DATA:";
135 PRINT #ZPLPORT: PACKET$; "^FS^XZ"
140 CLOSE #INPORT
150 GOTO 60 ! go look for the next connection
160 END
```

E-mail

ZBI can be used to enhance the printer's ability to send status via e-mail messages. The process is simple: open the email port "EML", send the recipient list, send the header, and send the body of the message.

The printer can only process a limited number of outgoing email messages at one time. For this reason, error handling should be used when opening the connection to wait for the printer to be ready to send the message. The EOT character is important for delimiting sections of the email message. If it is left out, the message will not be sent properly.

Before the following code will work, the email settings for the print server must be set up. Consult the print server manual to learn how to configure the unit.



Example • Here is an example of how to send e-mails:

```
1 REM EOT$ this is used to denote end of transmission
5 LET EOT$ = CHR$(4)
1 REM Open a connection to the e-mail port and if it errors
1 REM try again until complete
10 OPEN #1: NAME "EML"
15 ON ERROR GOTO 10
1 REM Specify address to send message to then end signal end
1 REM of recipients with EOT$
1 REM To send to multiple addressees separate addressees by
1 REM space
20 PRINT #1: "youraddress@yourdomain.com";EOT$;
1 REM Fill in the message information
30 PRINT #1: "From: HAL"
40 PRINT #1: "To: Dave"
50 PRINT #1: "Subject: A message from HAL"
60 PRINT #1: ""
70 PRINT #1: "Dave, I am sorry I can not let you do that."
80 PRINT #1: i
1 REM Terminate message
90 PRINT #1: "";EOT$
1 REM You must close the port, each open port is only good
1 REM for sending one message
100 CLOSE #1
```

File System

This section shows how programs and formats can be saved and recalled. Here's a quick list of these commands:

STORE Saves the program currently in memory as the specified file name.

LOAD Transfers a program file previously stored in the printer's memory and opens it in the ZBI Program Memory.

DIR With no filter included, prompts the printer to list all of the ZBI programs residing in all printer memory locations.

DELETE Removes a specified file from the printer's memory.

Runtime Access

The following example is a method to store runtime data in the printer memory. The file system in the printer is limited to writing one file at a time. Since only one component of the printer can have write access to the file system, the ZPL parser is the component with this access. For ZBI to use the ZPL parser as a gateway into printer memory, the ZPL comment command (^FX) is used.

**Example •**

```

AUTONUM 1,1
REM ***** TEST FOR SUBROUTINES *****
LET ZPLPORT = 1 OPEN #ZPLPORT: NAME "ZPL"
LET SIZE = 5
LET FILENAME$ = "R:TESTSYS.ZPL"
DECLARE STRING DATAIN$(SIZE)
LET DATAIN$(1) = "ONE"
LET DATAIN$(2) = "TWO"
LET DATAIN$(3) = "THREE"
LET DATAIN$(4) = "FOUR"
LET DATAIN$(5) = "FIVE"
GOSUB STOREDATA
GOSUB GETDATA
FOR I = 1 TO SIZE
IF DATAIN$(I) <> DATAOUT$(I) THEN
PRINT #ZPLPORT: "^XA^F0100,100^A0N,50,50^FDERROR:";
PRINT #ZPLPORT: DATAOUT$(I);"^XZ"
END IF
NEXT I
END
REM *** SUBROUTINE STOREDATA *****
REM INPUT: ZPLPORT, DATAIN$, SIZE, FILENAME$ *****
SUB STOREDATA
PRINT #ZPLPORT: "^XA^DF" & FILENAME$ & "^FS"
PRINT #ZPLPORT: "^FX"; SIZE; "^FS"
FOR I = 1 TO SIZE
PRINT #ZPLPORT: "^FX" & DATAIN$(I) & "^FS"
NEXT I
PRINT #ZPLPORT: "^XZ"
RETURN
REM *** SUBROUTINE GETDATA - *****
REM INPUT: ZPLPORT, FILENAME$ *****
REM ** OUTPUT: DECLARES AND FILLS DATAOUT$ AND FILLS SIZE
SUB GETDATA
PRINT #ZPLPORT: "^XA^HF" & FILENAME$ & "^XZ"
SLEEP 1
LET RESULT$ = ""
FOR J = 1 TO 25
LET A = READ(ZPLPORT,TEMP$,5000)
LET RESULT$ = RESULT$ & TEMP$
IF POS(RESULT$,"^XZ") <> 0 THEN
EXIT FOR
END IF
SLEEP 1
NEXT J
LET RESULT$(1:POS(RESULT$,"^FX")+2) = ""
LET SIZE = VAL(EXTRACT$(RESULT$,"","^"))
DECLARE STRING DATAOUT$(SIZE)
FOR I = 1 TO SIZE
LET RESULT$(1:POS(RESULT$,"^FX")+2) = ""
LET DATAOUT$(I) = EXTRACT$(RESULT$,"","^")

```

```
NEXT I  
LET RESULT$ = ""  
LET TEMP$ = ""  
RETURN
```

STORE

Description This command saves the program currently in memory as the specified file name. The format listed below is used.

Format `STORE <filename$>`

Parameters `<filename$>` = the name of the file to be stored. Drive location and file name must be in quotation marks.



Example • This is an example of how to use the `STORE` command:

```
STORE "E:PROGRAM1.BAS"
```

Comments For a file name to be valid, it must conform to the 8.3 Rule: each file must have no more than eight characters in the file name and have a three-character extension. Here the extension is always `.BAS` (for example, `MAXIMUM8.BAS`).

This is an interactive command that takes effect as soon as it is received by the printer.

The ZBI-Developer IDE will take care of this for you with the `SEND TO` option on your program.

LOAD

Description This command transfers a program file previously stored in the printer's memory and opens it in the ZBI Program Memory.

If the program file does not exist, the ZBI Program Memory is cleared and no program is opened.

Format `LOAD <filename$>`

Parameters `<filename$>` = the file name to be loaded into memory. Drive location and file name must be in quotation marks. If the drive location is not specified, all drives will be searched.



Example • Here are examples of how to use the LOAD command:

```
LOAD "PROGRAM1.BAS"  
LOAD "E:PROGRAM1.BAS"
```

Comments This is an interactive command that takes effect as soon as it is received by the printer.

DIR

Description This command, with no filter included, prompts the printer to list all of the ZBI programs residing in all printer memory locations.

Including a filter signals the printer to limit the search; including a drive location signals the printer to search in only one location.

Asterisks (*) are used as wild cards. A wild card (*) finds every incidence of a particular request. The example here, `DIR "B:*.BAS"`, signals the printer to search for every file with a .BAS extension in B: memory.

Format `DIR [<filter$>]`

Parameters [`<filter$>`] = the name of the file to be accessed (optional). Drive location and file name must be in quotation marks.

Default = `"*:*.*bas"`



Important • Quotes must be around what you are doing. This shows you how to use the wildcard (*) to search for all .BAS files in B: memory:

Quotes surrounding action



Example N/A

Comments This is an interactive command that takes effect as soon as it is received by the printer.

DELETE

Description This command removes a specified file from the printer's memory.

Format DELETE <filename\$>

Parameters <filename\$> = the name of the file to be deleted. Drive location and filename must be in quotation marks.



Example • This is an example of deleting a specified file from printer memory:

```
DELETE "E:PROGRAM1.BAS"
```

Comments This is an interactive command that takes effect as soon as it is received by the printer.

Comma Separated Values (CSV)

Accessing Comma Separated Value (CSV) and Text File Functions

This section describes the functions to access CSV files and ASCII plain-text files. Here is a quick list of these commands:

CSVLOAD Loads the contents of a CSV file in a two dimensional string array.

CSVSTORE Stores the contents of a two dimensional string array in a CSV file.

TXTLOAD Loads the contents of an ASCII plain-text file into a string variable.

TXTSTORE Stores the contents of a string variable in an ASCII plain text file.

CSVLOAD



Description This function will load the delimited values from a CSV file, defined by `FILENAME$`, and store them in the two-dimensional array, `DEST$`.

Format

```
CSVLOAD(DEST$, FILENAME$)
CSVLOAD(DEST$, FILENAME$, DELIM$)
```

Parameters

`DEST$` = two dimensional array that will hold the rows and columns from the CSV file specified by the `FILENAME$` variable. If there is not enough room in `DEST$`, or if it has the wrong size, it will be changed to fit the data from the file. The data originally in `DEST$` will be overwritten.

`FILENAME$` = name of the file to load. Drive location and file name must be in quotation marks. The file extension must be either ".CSV" or ".TXT".

`DELIM$` = optional delimiter that is used in the CSV file instead of a comma. If `DELIM$` is not provided a comma will be used by default. The delimiter must be a single character that is not a quote, carriage return, or newline.

Returns The number of elements in each row of the CSV file. The function will return 0 if errors were detected in the CSV file, or if the file could not be read.



Example • This example shows how to print the values in a CSV file with a comma delimiter.

```
10 DECLARE STRING CSVDB$(1,2)
20 LET FILENAME$ = "E:RECORDS.CSV"
30 LET NUMOFCOLS = CSVLOAD(CSVDB$, FILENAME$)
40 LET NUMOFROWS = ROWSIZE(CSVDB$)
100 FOR I = 1 TO NUMOFROWS STEP 1
110     FOR J = 1 TO NUMOFCOLS STEP 1
120         PRINT CSVDB$(I, J), " ";
200     NEXT J
210     PRINT ""
300 NEXT I
```



Example • This example shows how to print the values in a CSV file that uses a '|' as a delimiter.

```
10 DECLARE STRING CSVDB$(1,2)
20 LET FILENAME$ = "E:EMPLOYEE.CSV"
30 LET NUMOFCOLS = CSVLOAD(CSVDB$, FILENAME$, "|")
40 LET NUMOFROWS = ROWSIZE(CSVDB$)
100 FOR I = 1 TO NUMOFROWS STEP 1
110     FOR J = 1 TO NUMOFCOLS STEP 1
120         PRINT CSVDB$(I, J), " ";
200     NEXT J
210     PRINT ""
300 NEXT I
```

Comments The maximum CSV file size supported will vary based upon available RAM within the printer.

CSV File Information

The file format should follow the rules in IETF RFC 4180: <http://tools.ietf.org/html/rfc4180>

The maximum number of columns per row in a CSV file is 256.

Each row must be 2048 characters or less including the delimiter. The carriage return/line feed (CRLF) does not count toward the limit.

Each row in the CSV file must have the same number of elements. If there are any missing elements in the CSV file (indicated by two adjacent commas or a comma at the end of a row), they will be represented as empty strings.

If an element in the CSV file contains a quote, it should be represented as two quotes. Additionally, if an element contains a quote, a new line, a carriage return, or the delimiter character, the element must be within quotes. For example, a value that is used to store a measurement in feet and inches (4' 5") must be formatted as "4' 5'''' within the CSV file.

CSVSTORE



Description This function will store the values of a two dimensional array into a CSV file on the file system. Each element within the array is treated as a single value within the CSV file.

Format

```
CSVSTORE(SRC$, FILENAME$)
CSVSTORE(SRC$, FILENAME$, DELIM$)
```

Parameters

SRC\$ = two dimensional array of strings to be written to a CSV file.

FILENAME\$ = name of the file to store the array contents. Drive location and file name must be in quotation marks. The file extension must be either ".CSV" or ".TXT".

DELIM\$ = optional delimiter that is used in the CSV file instead of a comma. If DELIM\$ is not provided a comma will be used by default. The delimiter must be a single character that is not a quote, carriage return, or newline.

Returns A 0 if there were no errors. A 1 is returned if SRC\$ is not a string array, if the file could not be written, or if SRC\$ contains errors that prevent the file from being stored.



Example • This example shows how to convert a comma delimited CSV file into a "^" delimited TXT file and print the contents.

```
10 DECLARE STRING CSVDB$(1,2)
20 LET NUMOFCOLS = CSVLOAD(CSVDB$, "E:RECORDS.CSV")
30 LET CSVERROR = CSVSTORE(CSVDB$, "E:NEWREC.TXT", "^")
40 LET NUMOFCOLS = CSVLOAD(CSVDB$, "E:NEWREC.TXT", "^")
50 LET NUMOFROWS = ROWSIZE(CSVDB$)
100 FOR I = 1 TO NUMOFROWS STEP 1
110     FOR J = 1 TO NUMOFCOLS STEP 1
120         PRINT CSVDB$(I, J), " ";
200     NEXT J
210     PRINT ""
300 NEXT I
```

Comments The elements of the array should follow the rules in IETF RFC 4180: <http://tools.ietf.org/html/rfc4180>

There is no limit on the number of columns per row when storing to a CSV file. However, a file stored with rows that exceed the column limit imposed by CSVLOAD will not be loaded by the CSVLOAD function.

There is no limit on the size of a row when stored to a CSV file. However, a file stored with rows that exceed the size limit imposed by CSVLOAD will not be loaded by the CSVLOAD function.

TXTLOAD



Description This function will read the contents of an ASCII text file into a ZBI string variable.

Format `TXTLOAD(DEST$, FILENAME$)`

Parameters

`DEST$` = string to store the contents of `FILENAME$`.

`FILENAME$` = name of the file to read. Drive location and file name must be in quotation marks. The file extension must be either ".CSV" or ".TXT".

Returns The number of bytes read from the file. The function will return 0 if the file could not be read.



Example • This example shows how to print out the contents of a file.

```
10 LET TXTSIZE = TXTLOAD(TXTDATA$, "E:MYDATA.TXT")
20 PRINT STR$(TXTSIZE), "bytes:", TXTDATA$
```

Comments The data originally in `DEST$` will be overwritten upon completion of this function.

TXTSTORE



Description This function will store the contents of a ZBI string in an ASCII text file.

Format `TXTSTORE(SRC$, FILENAME$)`

Parameters

`SRC$` = string to store to `FILENAME$`.

`FILENAME$` = name of the file to store. Drive location and file name must be in quotation marks. The file extension must be either ".CSV" or ".TXT".

Returns Returns a 0 if there were no errors, otherwise a 1 is returned.



Example • This example shows how to append a text file.

```
10 LET TXTSIZE = TXTLOAD(TXTDATA$, "E:MYDATA.TXT")
11 REM Append a date/time stamp to the file
20 LET TXTDATA$ = TXTDATA$ & " " & DATE$ & " " & TIME$
30 LET TXTSIZE = TXTSTORE(TXTDATA$, "E:MYDATA.TXT")
40 PRINT TXTDATA$
```

Events

This section explains how to capture and trigger internal events in the printer. Here's a quick list of these commands:

Available Events A table that correlates a ZBI event with an identification number.

ZBI Key Names Details the names of each printer's front panel buttons, ZBI names, and ZBI event ID.

REGISTEREVENT Sets up the [HANDLEEVENT](#) function to receive notification when the specified event has occurred.

UNREGISTEREVENT Allows events that are currently set to be captured by the program to no longer be captured.

HANDLEEVENT Once events have been registered, this function is used to see what events have occurred.

TRIGGEREVENT Allows for front panel buttons to be triggered programatically.

There are certain events in the printer that a ZBI 2.0 program can receive. To do this, the program first registers for the event. On a regular basis, call a function to handle events. When an event occurs that the program is registered for, the function will return the event's identification number.

Available Events

ZBI Event ID	ZBI Event
1	menu key
2	pause key
3	feed key
4	cancel key
5	up arrow key
6	plus key
7	minus key
8	enter key
9	setup exit key
10	select key
11	cancel all event
12	config label
13	timer1
14	timer2
15	timer3
16	timer4
17	timer5
18	spare unused
19	previous key
20	next save key
21	calibrate key
22	paper out set
23	paper out clear
24	ribbon out set
25	ribbon out clear
26	head too hot set
27	head too hot clear
28	head cold set
29	head cold clear
30	head open set
31	head open clear
32	supply too hot set
33	supply too hot clear
34	ribbon in set
35	ribbon in clear
36	rewind full set
37	rewind full clear
38	cutter jammed set
39	cutter jammed clear

ZBI Event ID	ZBI Event
40	paused set
41	paused clear
42	pq completed set
43	pq completed clear
44	label ready set
45	label ready clear
46	head element bad set
47	head element bad clear
48	basic runtime set
49	basic runtime clear
50	basic forced set
51	basic forced clear
52	power on set
53	power on clear
54	clean printhead set
55	clean printhead clear
56	media low set
57	media low clear
58	ribbon low set
59	ribbon low clear
60	replace head set
61	replace head clear
62	battery low set
63	battery low clear
64	rfid error set
65	rfid error clear
66	any messages set
67	any messages clear
68	auto baud
69	factory default
70	networking default
71	networking factory
72	print width
73	darkness adjust
74	calibrate
75	scroll key

ZBI Key Names

This section details the names to use for each printer's front panel buttons when creating ZBI 2.0 programs to capture the buttons.

Xi4/RXi4/XiiiPlus/PAX4/105SL

XiiiPlus/PAX4/Xi4/RXi4 Front Panel Key	105SL Front Panel Key	ZBI Event ID	ZBI Name
Right Oval	Plus (+)	6	plus key
Left Oval	Minus (-)	7	minus key
Previous		19	previous key
Next/Save		20	next save key
Setup/Exit		9	setup exit key
Pause		2	pause key
Feed		3	feed key
Cancel		4	cancel key
Calibrate		21	calibrate key

HC100

Front Panel Key	ZBI Event ID	ZBI Name
Pause		pause key
Feed		feed key
Eject		eject key

ZM400/ZM600/RZ400/RZ600/Z4Mplus/Z6Mplus

Front Panel Key	ZBI Event ID	ZBI Name
Feed	3	feed key
Pause	2	pause key
Cancel	4	cancel key
Setup/Exit	9	setup exit key
Select	10	select key
Plus (+)	6	plus key
Minus (-)	7	minus key

S4M

Front Panel Key	ZBI Event ID	ZBI Name
Menu	1	menu key
Enter	8	enter key
Cancel	4	cancel key
Feed	3	feed key
Pause	2	pause key
Left Arrow	4	cancel key
Right Arrow	3	feed key
Up Arrow	5	up arrow key
Down Arrow	2	pause key

G-Series

Front Panel Key	ZBI Event ID	ZBI Name
Feed key	3	Feed key
Select key	10	Select key
Scroll key	75	Scroll key

2824 Plus Series

Front Panel Key	ZBI Event ID	ZBI Name
Feed key	3	Feed key

KR403

Front Panel Key	ZBI Event ID	ZBI Name
Feed key	3	Feed key

REGISTEREVENT



Description This function will set up the `HANDLEEVENT` function to receive notification when the specified event has occurred. Events can be registered for one time or until the program is exited.



Important • If an event occurs twice or more before the `HANDLEEVENT` function is called, only one event will be received.

Format

```
REGISTEREVENT(X)  
REGISTEREVENT(X,Y)  
REGISTEREVENT(X,Y,Z)
```

Parameters

(X) = This is the ID of the event being registered for.

(Y) = If Y=1: the event happens once; If Y=0: the event stays registered for the duration of the program, or until it is unregistered.

(Z) = For System Events: if Z=0, the event will still be handled by the printer. If Z=1, then only ZBI will receive the event.

For Timer Events: this is the timer interval in mSec. If the interval is less than 0 or greater than 1,000,000,000, it is set to 1000.

Returns The ID of the successfully registered event. If an event was not successfully registered, a -1 is returned.



Example • Here is an example of how to use the REGISTEREVENT command:

```
1 REM This example shows how to override the functionality of the feed
1 REM key
1 REM using the event system. After all why waste a label when you
1 REM could put
1 REM valuable information there
AUTONUM 1,1
CLOSE ALL
LET ZPLPORT = 1
OPEN #ZPLPORT: NAME "ZPL"
LET FEEDKEY = 3
LET TMP = REGISTEREVENT(FEEDKEY, 0, 1)
DO WHILE 1 = 1
LET EVT = HANDLEEVENT()
IF EVT = FEEDKEY THEN
GOSUB PRINTINFO
END IF
SLEEP 1
LOOP
REM **** SUBROUTINE PRINTINFO *** expects ZPLPORT ****
SUB PRINTINFO
PRINT #ZPLPORT: "^XA"
PRINT #ZPLPORT: "^F030,30^A0N,50,50^FDZebra Technologies^FS"
PRINT #ZPLPORT: "^F030,85^A0N,35,35^FDwww.zebra.com^FS"
PRINT #ZPLPORT: "^F030,125^A0N,35,35^FDsupport.zebra.com^FS"
PRINT #ZPLPORT: "^F030,165^A0N,35,35^FDFW Version: "
PRINT #ZPLPORT: GETVAR$("appl.name") & "^FS"
PRINT #ZPLPORT: "^F030,205^A0N,35,35^FDPrinter Unique ID:"
PRINT #ZPLPORT: GETVAR$("device.unique_id") & "^FS"
PRINT #ZPLPORT: "^F030,245^A0N,35,35^FDActive Network: "
PRINT #ZPLPORT: GETVAR$("ip.active_network") & "^FS"
PRINT #ZPLPORT: "^F030,285^A0N,35,35^FDZBI Memory Usage: "
PRINT #ZPLPORT: GETVAR$("zbi.start_info.memory_alloc") & "^FS"
PRINT #ZPLPORT: "^F030,325^A0N,35,35^FDOdometer: "
PRINT #ZPLPORT: GETVAR$("odometer.total_print_length") & "^FS"
PRINT #ZPLPORT: "^XZ"
```

Comments None

UNREGISTEREVENT



Description This function allows events that are currently set to be captured by the program to no longer be captured. Once called events will return to the normal method of processing if the REGISTEREVENT function Z parameter was set to 1.

Format UNREGISTEREVENT(X)

Parameters (X) = the ID of the event to stop

Returns 0 if the event is a valid event to unregister. A -1 if the event does not exist.



Example • Here is an example of how to use the UNREGISTEREVENT command:

```
AUTONUM 1,1
LET OUTSTR$ = "Processing"
LET LOOPCTR = 200
LET TIMERS5 = 17
LET TMP = REGISTEREVENT(TIMERS5, 0, 1000)
DO WHILE LOOPCTR > 0
LET EVT = HANDLEEVENT()
IF EVT = TIMERS5 THEN
LET A = SETVAR("device.frontpanel.line2",OUTSTR$)
LET OUTSTR$ = OUTSTR$ & "."
IF LEN(OUTSTR$) >16 THEN
LET OUTSTR$ = "Processing"
END IF
END IF
LET LOOPCTR = LOOPCTR - 1
SLEEP 1
LOOP
LET TMP = UNREGISTEREVENT(TIMERS5)
LET A = SETVAR("device.frontpanel.line2","")
END
```

Comments None

HANDLEEVENT



Description Once events have been registered, this function is used to see what events have occurred.

Format HANDLEEVENT()

Parameters N/A

Returns The ID of the event that occurred. One event at a time will be returned through this function. The order of the events are based on priority. The priority is based on the ID number of the event, with the exception of the timer events, which have the highest priority.



Example • Here are examples of how to use the HANDLEEVENT command:

```
1 REM This example shows how to override the feed key functionality
1 REM using the event system. Why waste a label when you could put
1 REM valuable information there
AUTONUM 1,1
CLOSE ALL
LET ZPLPORT = 1
OPEN #ZPLPORT: NAME "ZPL"
LET FEEDKEY = 3
LET TMP = REGISTEREVENT(FEEDKEY, 0, 1)
DO WHILE 1 = 1
LET EVT = HANDLEEVENT()
IF EVT = FEEDKEY THEN
GOSUB PRINTINFO
END IF
SLEEP 1
LOOP
REM ***** SUBROUTINE PRINTINFO ***
REM *** expects ZPLPORT *****
SUB PRINTINFO
PRINT #ZPLPORT: "^XA"
PRINT #ZPLPORT: "^F030,30^A0N,50,50";
PRINT #ZPLPORT: "^FDZebra Technologies^FS"
```

```
PRINT #ZPLPORT: "^F030,85^A0N,35,35";
PRINT #ZPLPORT: "^FDwww.zebra.com^FS"
PRINT #ZPLPORT: "^F030,125^A0N,35,35";
PRINT #ZPLPORT: "^FDSsupport.zebra.com^FS"
PRINT #ZPLPORT: "^F030,165^A0N,35,35";
PRINT #ZPLPORT: "^FDFW Version: ";
PRINT #ZPLPORT: GETVAR$("appl.name") & "^FS"
PRINT #ZPLPORT: "^F030,205^A0N,35,35";
PRINT #ZPLPORT: "^FDPrinter Unique ID:";
PRINT #ZPLPORT: GETVAR$("device.unique_id") & "^FS"
PRINT #ZPLPORT: "^F030,245^A0N,35,35";
PRINT #ZPLPORT: "^FDActive Network: ";
PRINT #ZPLPORT: GETVAR$("ip.active_network") & "^FS"
PRINT #ZPLPORT: "^F030,285^A0N,35,35";
PRINT #ZPLPORT: "^FDZBI Memory Usage: ";
PRINT #ZPLPORT: GETVAR$("zbi.start_info.memory_alloc") & "^FS"
PRINT #ZPLPORT: "^F030,325^A0N,35,35";
PRINT #ZPLPORT: "^FDOdometer: ";
PRINT #ZPLPORT: GETVAR$("odometer.total_print_length") & "^FS"
PRINT #ZPLPORT: "^XZ"
```

Comments None

TRIGGEREVENT



Description This function allows for front panel buttons to be triggered programatically.

Format TRIGGEREVENT(X)

Parameters

X = the ID of the event from the possible event list to TRIGGER.

See the following printer tables for events that can be triggered by this command:

- *Xi4/RXi4/XiIIIPlus/PAX4/105SL on page 549*
- *105SL Front Panel Key on page 549*
- *ZM400/ZM600/RZ400/RZ600/Z4Mplus/Z6Mplus on page 549*
- *S4M on page 550*

Returns Always returns 0.



Example • Here are examples of how to use the TRIGGEREVENT command:

```
1 REM THIS IS AN EXAMPLE OF HOW TO TRIGGER AN EVENT
AUTONUM 1,1
LET PAUSEKEY = 2
DO WHILE 1 = 1
LET A = TRIGGEREVENT(PAUSEKEY)
LET A = SETVAR("device.frontpanel.line2",str$(A))
SLEEP 2
LOOP
```

Comments None

Systems

This section contain miscellaneous systems interface functions. Here's a quick list of these commands:

ISERROR Returns a non-zero value if there is an internal error set in the printer.

ISWARNING Returns a non-zero value if there is an internal warning set in the printer.

SLEEP Specifies the time that the interpreter pauses.

SETERR Sends a message to the printer to set the error flag.

CLRERR Sends a message to the printer to clear the error flag.

ON ERROR Prevents a program from halting in the event of an error.

ISERROR

Description This function returns a non-zero value if there is an internal error set in the printer. Otherwise, the numeral returned will 0.

Format ISERROR

Parameters N/A

Returns 0 for no errors; 1 if there is an error.



Example • Here is an example of the ISERROR command.

```
10 PRINT ISERROR  
RUN  
0
```

Comments None

ISWARNING

Description This function returns a non-zero value if there is an internal warning set in the printer. Otherwise, the numeral returned will 0.

Format ISWARNING

Parameters N/A

Returns 0 for no errors; 1 if there is an error.



Example • Here is an example of the ISWARNING command.

```
10 PRINT ISWARNING  
RUN  
0
```

Comments None

SLEEP

Description This command specifies the time that the interpreter pauses. This command could be sent to the printer after sending a label format to be printed. The interpreter pauses in its processing for the amount of time specified.

Format SLEEP <A>

Parameters <A> = the time in seconds (0 to 500) the interpreter pauses.



Example • This is an example of how to use the SLEEP command:

```
10 SLEEP 450
```

Comments If a timer is needed, use the [Event](#) system. The timer will allow for processing other items, where SLEEP will stop execution of any ZBI commands for the specified SLEEP period.

This is a program command and must be preceded by a line number.

Calling SLEEP with <A> set to zero will force the ZBI task to yield to the rest of the system and allow any pending tasks to run (e.g., pending ZPL commands). If there are no pending tasks, ZBI will sleep for a minimum of 8 milliseconds.

SETERR

Description This command sends a message to the printer to set the error flag. A logical interpreter flag is triggered in the printer. This error is referenced as a BASIC Forced Error.

Format SETERR

Parameters N/A



Example • An example of the SETERR and CLRERR commands.

```
AUTONUM 1,1
OPEN #1:NAME "ZPL"
PRINT #1: "^XA^SX0,A,Y,Y^XZ"
CLOSE #1
FOR I=1 TO 10
SLEEP 5
IF MOD(I,2)=1 THEN
SETERR
ELSE
CLRERR
ENDIF
NEXT I
```

Comments This is a program command and must be preceded by a line number.

CLRERR

Description This command sends a message to the printer to clear the error flag. A logical interpreter flag is cleared in the printer. This error is referenced as a BASIC Forced Error.

Format 10 CLRERR

Parameters N/A



Example • See *SETERR on page 561*.

Comments This is a program command that is preceded by a line number.

ON ERROR

Description The `ON ERROR` command can be used to prevent a program from halting in the event of an error. If an error occurs in a previous line during program execution, the `ON ERROR` statement calls the `GOTO` or `GOSUB` statement and allows the program to continue.

Format

```
ON ERROR GOTO <A>  
ON ERROR GOSUB <A>
```

Parameters <A> = the destination location in the program should an error be triggered on the previous line.



Example • This is an example of how to use the `ON ERROR` command:

```
30 LET A = B/C  
40 ON ERROR GOTO 100  
...  
100 PRINT "DIVIDE BY ZERO OCCURRED"  
110 LET A = 0  
120 GOTO 50  
...
```

Example • See *TCP Server on page 529* or *UDP Server on page 531*.

Comments

If there is no error, this line is ignored.

This is a program command that is preceded by a line number.

Applicator Functions

The printer applicator port option can be controlled in part or completely by ZBI 2. When ZBI takes control of a pin, the printer's built-in applicator functionality will not have access to that pin. This function will allow the printer to perform some of the functionality that a programmable logic controller (PLC) could.

AUXPORT_STEALPIN Takes control of a pin and allows ZBI to perform other actions on the pin.

AUXPORT_SETPIN Sets the output level on an applicator pin.

AUXPORT_GETPIN Retrieves the state of the applicator pin.

AUXPORT_RELEASEPIN Returns a pin controlled by ZBI to normal printer operation.

AUXPORT_STEALPIN



Description This function will take control of a pin and allow ZBI to perform other actions on the pin.

Format AUXPORT_STEALPIN(x)

Parameters x = perform action on this applicator port pin.

Returns This function returns -1 upon failure and 0 upon success.



Example • This is an example of the AUXPORT_STEALPIN command:

```
1 REM Demo applicator to show control of applicator pins
1 REM on the printer
1 REM The application is to create a light pole with an
1 REM external feed button
AUTONUM 1,1
LET RED = 9
LET YELLOW = 10
LET GREEN = 11
LET BUTTON = 4
LET FEED_KEY = 3
LET TMP = AUXPORT_STEALPIN(RED)
LET TMP = AUXPORT_STEALPIN(YELLOW)
LET TMP = AUXPORT_STEALPIN(GREEN)
LET TMP = AUXPORT_STEALPIN(BUTTON)
DO WHILE 1 = 1
SLEEP 1
IF ISERROR = 1 THEN
LET TMP = AUXPORT_SETPIN(RED,1)
LET TMP = AUXPORT_SETPIN(YELLOW,0)
LET TMP = AUXPORT_SETPIN(GREEN,0)
ELSE IF ISWARNING = 1 THEN
LET TMP = AUXPORT_SETPIN(RED,0)
LET TMP = AUXPORT_SETPIN(YELLOW,1)
LET TMP = AUXPORT_SETPIN(GREEN,0)
ELSE
LET TMP = AUXPORT_SETPIN(RED,0)
LET TMP = AUXPORT_SETPIN(YELLOW,0)
LET TMP = AUXPORT_SETPIN(GREEN,1)
END IF
IF AUXPORT_GETPIN(BUTTON) = 1 THEN
LET A = TRIGGEREVENT(FEED_KEY)
END IF
LOOP
```

Comments If this pin is not controlled via ZBI (power pin), this function will return -1.

AUXPORT_SETPIN



Description This function sets the output level on an applicator pin.

Format AUXPORT_SETPIN(*x*,*y*)

Parameters

x = perform action on this applicator port pin.

y = The value to set on the pin (1 = high, 0 = low).

Returns This function returns -1 upon failure and 0 upon success.



Example • See *AUXPORT_STEALPIN* on page 565.

Comments If this pin is not controlled via ZBI (power pin), this function will return -1. See *AUXPORT_STEALPIN* on page 565.

AUXPORT_GETPIN



Description This function will retrieve the state of the applicator pin.

Format AUXPORT_GETPIN(x)

Parameters x = perform action on this applicator port pin.

Returns This function returns 1 if pin is in high state, 0 in low state, and -1 upon failure.



Example • See *AUXPORT_STEALPIN* on page 565.

Comments If this pin is not controlled via ZBI (power pin), this function will return -1. See *AUXPORT_STEALPIN* on page 565.

AUXPORT_RELEASEPIN



Description This function returns a pin controlled by ZBI to normal printer operation.

Format AUXPORT_RELEASEPIN(x)

Parameters x = perform action on this applicator port pin.

Returns This function returns -1 upon failure and 0 upon success.



Example • This is an example of the AUXPORT_RELEASEPIN command:

```
90 LET TMP = AUXPORT_RELEASEPIN(X)
```

Comments If this pin is not controlled via ZBI (power pin), this function will return -1. See *AUXPORT_STEALPIN* on page 565.

String Functions

This section identifies how to handle string manipulation. Here is a quick list of these commands:

LCASE\$ Converts a string to all lowercase characters.

CHR\$ Takes a value between 0 and 255 and puts that value into a string.

LTRIM\$ Removes leading spaces from a string.

REPEAT\$ Creates multiple copies of a string combined into a new string.

RTRIM\$ Returns a string with trailing spaces removed

SPLIT Splits a string into sub-strings

SPLITCOUNT Returns the number of sub-strings that would be returned by the SPLIT function.

UCASE\$ Converts a string to all uppercase characters

EXTRACT\$ Searches for a string based on a starting and ending string.

ORD Returns the ASCII value of the first character of string A\$.

POS Returns the location of the first occurrence of a search string in the target string.

LEN Returns the length of a string.

LCASE\$

Description This function will convert a string to all lowercase characters.

Format `LCASE$ (A$)`

Parameters `(A$)` = the string that will be converted

Returns The characters in `A$` converted to lowercase.



Example • This is an example of how to use the `LCASE$` command.

```
10 LET B$=LCASE$ ("Hello World")
20 PRINT B$
RUN
hello world
```

Comments This will only work on non-accented Latin characters, A-Z.

CHR\$

Description This function takes a value between 0 and 255 and puts that value into a string.

Format CHR\$(VAL)

Parameters (VAL)= The numeric value of the string character.

Returns A single character string containing the value entered.



Example • This is an example of how to use the CHR\$ command to easily put control characters into strings:

```
10 LET NULL$=CHR$(0)
20 LET STX$=CHR$(2)
30 LET ETX$=CHR$(3)
40 LET EOT$=CHR$(4)
```

Comments None

LTRIM\$

Description This function removes leading spaces from a string.

Format LTRIM\$(A\$)

Parameters (A\$) = the string to convert.

Returns The string in A\$ with no spaces.



Example • This is an example of how to use the LTRIM\$(A\$) command:

```
10 LET A$=" Hello"  
20 PRINT LTRIM$(A$)  
RUN  
HeLlO
```

Comments None

REPEAT\$

Description This function creates multiple copies of a string combined into a new string.

Format REPEAT\$(A\$,M)

Parameters

A\$ = the base string to duplicate

M = the number of times to duplicate A\$

Returns A string containing M copies of A\$. **Note:** When M=0, an empty string is returned.



Example • This is an example of how to use the REPEAT\$ (A\$, M) command:

```
10 PRINT REPEAT$("Hello",3)
RUN
HeLlOHeLlOHeLlO
```

Comments None

RTRIM\$

Description This function returns a string with trailing spaces removed.

Format RTRIM\$(A\$)

Parameters (A\$) = the base string

Returns A\$ with trailing spaces removed.



Example • This is an example of how to use the RTRIM\$(A\$) command:

```
10 LET A$="Hello "  
20 LET B$="World"  
30 PRINT A$ & B$  
40 PRINT RTRIM$(A$)& B$  
RUN  
Hello World  
HelloWorld
```

Comments None

SPLIT



Description This function allows a string to be split into sub-strings

Format

```
SPLIT(DEST$,SOURCE$,DELIMITER$)
SPLIT(DEST$,SOURCE$,DELIMITER$,MAXCOUNT)
```

Parameters

DEST\$ = the array to populate with the sub-strings created by the split

SOURCE\$ = the string that will be searched for the provided delimiter

DELIMITER\$ = the delimiter string (may be more than one character) to search for

MAXCOUNT = the maximum number of sub-strings the string should be split into. A negative value will return every sub-string created by the split. A value of zero will return empty strings in the array. If not specified, the limit will be the maximum size of the array.

Returns The number of sub-strings placed into the DEST\$ array. If the number of sub-strings is less than the size of DEST\$, the remaining elements of the array will be set to empty strings.



Example • This is an example of how to use the SPLIT command:

```
1 REM Example - This example show how the SPLIT and SPLITCOUNT
1 REM commands can be
1 REM used to merge a comma separated variable string(CSV)
1 REM into a stored format
AUTONUM 1,1
SLEEP 10
DECLARE STRING TESTDATA$(5)
REM data format = <Format Name>,<VAR 1>,<VAR 2>,...,<VAR N>
LET TESTDATA$(1) = "E:PRICETAG.ZPL,FRED'S
OATS,$1.25,C:126789:325,123456789"
LET TESTDATA$(2) = "E:PRICETAG.ZPL,FRED'S
OATS,$2.25,C:126789:325,123456789"
LET TESTDATA$(3) = "E:PRICETAG.ZPL,FRED'S
OATS,$3.25,C:126789:325,123456789"
LET TESTDATA$(4) = "E:PRICETAG.ZPL,FRED'S
OATS,$4.25,C:123489:325,123456789"
LET TESTDATA$(5) = "E:PRICETAG.ZPL,FRED'S
OATS,$5.25,C:123459:325,123456789"
LET ZPLPORT = 2
OPEN #ZPLPORT: NAME "ZPL"
FOR T = 1 TO 5
LET DATA$ = TESTDATA$(T)
GOSUB CSVPRINTER
NEXT T
END
```

```

REM ***** Subroutine CSVPRINTER, expects DATA$ and ZPLPORT
*****
SUB CSVPRINTER
LET CNT = SPLITCOUNT(DATA$, ",")
DECLARE STRING SPLITSTRING$(CNT)
ON ERROR GOTO RECOVERY
LET CNT = SPLIT(SPLITSTRING$,DATA$,",")
PRINT #ZPLPORT: "^XA^XF";SPLITSTRING$(1);"^FS"
IF CNT >= 2 THEN
FOR I = 2 TO CNT
PRINT #ZPLPORT: "^FN";I-1;"^FD";SPLITSTRING$(I);"^FS"
NEXT I
END IF
PRINT #ZPLPORT: "^XZ"
SUB RECOVERY
RETURN

```



Example • This is an example of how to use the SPLIT command:

```

1 REM Example - Shows how the SPLIT and SPLITCOUNT commands can be used to
1 REM merge a comma separated variable string(CSV) into a stored format
AUTONUM 1,1
SLEEP 10
DECLARE STRING TESTDATA$(5)
REM data format = <Format Name>,<VAR 1>,<VAR 2>,...,<VAR N>
LET F$="E:PRICETAG.ZPL"
LET TESTDATA$(1) = F$&" ,FRED'S ROLLED OATS,$1.25,C:123456789:325,123456789"
LET TESTDATA$(2) = F$&" ,FRED'S ROLLED OATS,$2.25,C:123456789:325,123456789"
LET TESTDATA$(3) = F$&" ,FRED'S ROLLED OATS,$3.25,C:123456789:325,123456789"
LET TESTDATA$(4) = F$&" ,FRED'S ROLLED OATS,$4.25,C:123456789:325,123456789"
LET TESTDATA$(5) = F$&" ,FRED'S ROLLED OATS,$5.25,C:123456789:325,123456789"
LET ZPLPORT = 2
OPEN #ZPLPORT: NAME "ZPL"
FOR T = 1 TO 5
LET DATA$ = TESTDATA$(T)
GOSUB CSVPRINTER
NEXT T
END
REM ***** Subroutine CSVPRINTER, expects DATA$ and ZPLPORT
*****
SUB CSVPRINTER
LET CNT = SPLITCOUNT(DATA$, ",")
DECLARE STRING SPLITSTRING$(CNT)
ON ERROR GOTO RECOVERY
LET CNT = SPLIT(SPLITSTRING$,DATA$,",")
PRINT #ZPLPORT: "^XA^XF";SPLITSTRING$(1);"^FS"
IF CNT >= 2 THEN
FOR I = 2 TO CNT
PRINT #ZPLPORT: "^FN";I-1;"^FD";SPLITSTRING$(I);"^FS"
NEXT I
END IF
PRINT #ZPLPORT: "^XZ"
SUB RECOVERY
RETURN

```

Comments If the delimiter is an empty string, or does not appear in the `SOURCE$` string, the first entry of the array will be the source string and all other elements will be empty strings.

When the `SPLIT` function encounters a delimiter at the beginning or end of the source string, or two delimiters in a row, it populates the corresponding array element with an empty string.

If `MAXCOUNT` is larger than the number of returned sub-strings (N), the last `MAXCOUNT - N` array elements will be empty strings. If `MAXCOUNT` is larger than the destination array or is negative, the size of the array will be used as the `MAXCOUNT`. Therefore, the smallest value among the value of `MAXCOUNT`, the size of the return array, or the number of sub-strings found determines the maximum number of sub-strings that will be returned.

If `MAXCOUNT` is less than the number of delimiters in a string the last string in the array will hold the end of the string starting from where the last delimiter was found. For example, if `SOURCE$ = "one,two,three,four,five"`, `DELIMITER$ = ","`, and `MAXCOUNT = 2`, the output would be two strings: "one" and "two,three,four,five".

If a two dimensional array is provided for `DEST$`, the array will be filled linearly. For example, an array that is 2 x 3 (for example, `DECLARE STRING MYARRAY$(2,3)`) will be filled from (0,0), then (0,1) up to (2,3).

SPLITCOUNT



Description This function returns the number of sub-strings that would be returned by the SPLIT function.

Format SPLITCOUNT(SOURCE\$, DELIMITER\$)

Parameters

SOURCE\$ = the string that will be searched for the provided delimiter.

DELIMITER\$ =5

Returns The number of sub-strings that would be returned by the SPLITCOUNT function.



Example • This function shows how to determine the number of sub-strings that the SPLITCOUNT command would produce

```
10 LET CNT = SPLITCOUNT("ONE,,FOUR,FIVE,,SEVEN,", ",")
20 PRINT "Number of sub-strings returned is", STR$(CNT)
RUN
Number of sub-strings returned is 8
```

Comments None

UCASE\$

Description This function converts a string to all uppercase characters.

Format UCASE\$(A\$)

Parameters A\$ = the base string to convert

Returns A\$ converted to uppercase.



Example • This is an example of how to use the UCASE\$(A\$) command:

```
10 LET A$="Zebra Technologies"  
20 PRINT UCASE$(A$)  
RUN  
ZEBRA TECHNOLOGIES
```

Example • This is an example of how to capitalize a line.

```
10 LET A$="The Cow jUmPed Over THE Moon."  
20 LET A$=LCASE$(A$)  
30 LET A$(1:1)=UCASE$(A$(1:1))  
40 PRINT A$  
RUN  
The cow jumped over the moon.
```

Comments This will only convert non-accented Latin characters, a-z.

EXTRACT\$

Description This function searches for a string based on a starting and ending string. When these two strings are found, the string between them is returned.



Important • If the EXTRACT\$ command encounters a carriage return line feed before encountering the beginning character or the ending character, it returns null.

Format

```
EXTRACT$ (CHANNEL, START$, STOP$)
EXTRACT$ (A$, START$, STOP$)
```

Parameters

CHANNEL = extracts data from this channel

A\$ = the source string

START\$ = Once this string is found, the extract pulls characters immediately following.

STOP\$ = the extraction stops when this string is found



Example • This example shows how to extract the word Technologies from this string: Zebra, Technologies, Corporation.

This is what the program looks like to accomplish this:

```
10 LET A$ = "Zebra,Technologies,Corporation,"
20 LET DATA$ = EXTRACT$(A$,"","")
```



Example • This example shows how the EXTRACT\$ command works from an open port:

```
10 OPEN #1: NAME "SER"
20 LET DATA$ = EXTRACT$(1,"","")
```

Notice how the quotes are used to show a literal character, in this case a comma.



Example • This example shows how the start and stop points are variable; a variable name is used instead of the literal:

```
10 LET B$ = ","
20 LET A$ = "Zebra,Technologies,Corporation"
30 LET DATA$ = EXTRACT$(A$,B$,B$)
40 PRINT DATA$
RUN
Technologies
```



Example • This example shows how an empty string can be used to extract from the start of the input string to the end string:

```
10 LET IN$ = "BLAH BLAH <END>"
20 LET B$ = EXTRACT$(IN$, "", "<END>")
30 PRINT B$
RUN
BLAH BLAH
```



Example • This example will use an empty string to extract to the end of a line:

```
10 LET IN$ = "BLAH <START> THE DATA"
20 LET B$ = EXTRACT$(IN$, "<START>", "")
30 PRINT B$
RUN
THE DATA
```

Comments EXTRACT\$ reads in and discards data until the start criteria is met. Then, all data is returned up to the stop criteria.

ORD

Description This function returns the ASCII value of the first character of string A\$.

Format ORD(A\$)

Parameters A\$ = Input string: only the first character will be used.

Returns The ASCII value of the first character.



Example • This is an example of how to use the ORD (A\$) command:

```
10 LET A$="ABC"  
20 PRINT ORD(A$)  
RUN  
65
```

Comments None

POS

Description This function returns the location of the first occurrence of a search string in the target string. It can be assigned an index.

Format

```
POS(A$,B$)
POS(A$,B$,M)
```

Parameters

A\$ = the target string to search

B\$ = the search string to find in **A\$**

M = The index to start looking for **B\$**. If omitted, the search will start at the beginning of the string. **M** must be greater than zero.

Returns The location of the string. If the string is not found, this will return 0.



Example • This is an example of how to use the POS command:

```
10 LET A$="Hello World"
20 LET B$="o"
30 PRINT POS(A$,B$)
40 PRINT POS(A$,B$,1)
50 PRINT POS(A$,B$,6)
RUN
5
5
8
```

Comments None

LEN

Description This function returns the length of a string.

Format `LEN(A$)`

Parameters `A$` = the target string from which to determine the length.

Returns The length of the string.



Example • This example identifies the length of a string. Hello World is 11 characters, as follows:

```
10 LET A$="Hello World"  
20 PRINT LEN(A$)  
RUN  
11
```

Comments None

Math Functions

This section identifies how to handle mathematical calculations. Here is a quick list of these commands:

STR\$ Converts a number to a string.

MAX Returns the greater value between two numbers.

MIN Returns the smaller value of two numbers.

MAXNUM returns the largest number permitted by this machine.

MOD Computes the remainder from division.

VAL Evaluates the number represented by a string.

INTTOHEX\$ Takes a numeric value and converts it into a hexadecimal string.

HEXTOINT Converts hexadecimal strings to integers.

STR\$

Description This function converts a number to a string.

Format STR\$(X)

Parameters X = the number to convert to a string

Returns A string representing X.



Example • This is an example of how to use the STR\$(X) command:

```
10 LET A=53
20 PRINT STR$(A)
RUN
53
```

Comments None

MAX

Description This function returns the greater value between two numbers.

Format MAX(X,Y)

Parameters

X = the first number to compare

Y = the second number to compare

Returns The greater of X or Y.



Example • This is an example of how to use the MAX (X, Y) command:

```
10 LET A=-2
20 LET B=1
30 PRINT MAX(A,B)
RUN
1
```

Comments None

MIN

Description This function returns the smaller value of two numbers.

Format `MIN(X,Y)`

Parameters

X = the first number to compare

Y = the second number to compare

Returns The smaller of X or Y.



Example • This is an example of how to use the MIN (X, Y) command:

```
10 LET A=-2
20 LET B=0
30 PRINT MIN(A,B)
RUN
-2
```

Comments None

MAXNUM

Description This function returns the largest number permitted by this machine: 2,147,483,647.

Format MAXNUM

Parameters N/A

Returns The largest number that the NUMERIC type can handle (2,147,483,647).



Example • This is an example of how to use the MAXNUM command:

```
10 PRINT MAXNUM  
RUN  
2147483647
```

Comments None

MOD

Description This function computes the remainder from division. (This is known as the modulus.)

Format `MOD(X,Y)`

Parameters

X = the value to be modulated (numerator).

Y = the base number or divisor (denominator).

Returns The remainder of the division (X/Y).



Example • This is an example of how to use the MOD (*X*, *Y*) command:

```
10 PRINT MOD(25,10)
20 PRINT MOD(2,1)
30 PRINT MOD(3,2)
40 PRINT MOD(9,2)
50 PRINT MOD(-2,9)
60 PRINT MOD(2,0)
RUN
5
0
1
1
-2
ERROR OCCURRED ON LINE 60:DIVIDE BY ZERO
```

Comments None

VAL

Description This function evaluates the number represented by a string.

Format VAL(A\$)

Parameters A\$ = This is the input string to pull the number from. Non-numbers are ignored.

Returns The numeric representation of the string.



Example • This is an example of how to use the VAL (A\$) command:

```
10 LET A$="123"  
20 LET C=VAL(A$)  
30 PRINT C  
RUN  
123  
  
PRINT VAL("321A123")  
321123
```

Comments None

INTTOHEX\$



Description This function will take a numeric value and convert it into a hexadecimal string. The range of values for integers is:

-2,147,483,648 to +2,147,483,647

Format INTTOHEX\$(A)

Parameters A = The numeric value to convert.

Returns A string representing the integer in hex.



Example • These print statements show the output of the INTTOHEX\$ function given different values.

```
PRINT INTTOHEX$(1)  
1
```

```
PRINT INTTOHEX$(10)  
A
```

```
PRINT INTTOHEX$(16)  
10
```

```
PRINT INTTOHEX$(20)  
14
```

```
PRINT INTTOHEX$(30)  
1E
```

```
PRINT INTTOHEX$(100)  
64
```

```
PRINT INTTOHEX$(123124)  
1E0F4
```

```
PRINT INTTOHEX$(-5)  
0
```

```
PRINT INTTOHEX$(-99)  
0
```

Comments Negative values will be returned as 0.

HEXTOINT



Description This function will convert hexadecimal strings to integers.

Format HEXTOINT(A\$)

Parameters A\$ = The hex string to convert.

Returns A integer string computed from the hexadecimal string.



Example • These print statements show the output of the [INTTOHEX](#) function given different values.

```
PRINT HEXTOINT("0")
```

```
0
```

```
PRINT HEXTOINT("A")
```

```
10
```

```
PRINT HEXTOINT("a")
```

```
10
```

```
PRINT HEXTOINT("1A")
```

```
26
```

```
PRINT HEXTOINT("10")
```

```
16
```

```
PRINT HEXTOINT("AaAa")
```

```
43690
```

```
PRINT HEXTOINT("AAAA")
```

```
43690
```

```
PRINT HEXTOINT("-1")
```

```
0
```

```
PRINT HEXTOINT("-A")
```

```
0
```

Comments Negative values will be returned as 0.

Array Functions

This section describes the functions to search, resize, and query arrays.

REDIM Changes the size of an array.

INSERTROW Inserts a new row into an existing array.

DELROW Deletes a new row from an existing array

ROWSIZE Returns the number of rows in an array.

COLUMNSIZE Returns the number of columns in an array.

FIND Searches a string array for an occurrence of a sub-string.

REDIM



Description This command will change the dimensions of an array.

Format

```
REDIM <ARRAYNAME>(<SIZE>)  
REDIM <ARRAYNAME>(<ROWS>,<COLUMNS>)  
REDIM <ARRAYNAME$>(<SIZE>)  
REDIM <ARRAYNAME$>(<ROWS>,<COLUMNS>)
```

Parameters

<SIZE> = new number of entries in a single dimension array.
<ROWS> = new number of rows in a two dimensional array.
<COLUMNS> = new number of columns in a two dimensional array.



Example • This example shows how to change a one dimensional numeric array.

```
10 DECLARE NUMERIC SCORES(3)  
20 LET SCORES(1) = 85  
30 LET SCORES(2) = 92  
40 LET SCORES(3) = 98  
50 REDIM SCORES(2) ! Discard the last one
```



Example • This example shows how to change a two dimensional string array.

```
10 DECLARE STRING NAMEAGES$(3,2)  
20 LET NAMEAGES$(1,1) = "Abraham"  
30 LET NAMEAGES$(1,2) = "Lincoln"  
40 LET NAMEAGES$(2,1) = "Dwight"  
50 LET NAMEAGES$(2,2) = "Eisenhower"  
60 LET NAMEAGES$(3,1) = "Theodore"  
70 LET NAMEAGES$(3,2) = "Roosevelt"  
80 REDIM NAMEAGES$(5,2) ! Make room for more
```

Comments The **REDIM** must have the same number of dimensions as the original declaration of the array.

If the array has two dimensions, the second array bound cannot change. It must have the same value as the original declaration.

If **REDIM** makes an array smaller, elements (or rows, for a two dimensional array) at the end of the array are discarded.

If **REDIM** makes an array larger, elements (or rows) are added at the end of the array, and initialized as they would be with a **DECLARE**.

This can be an interactive command that takes effect as soon as it is received by the printer, or a program command that is preceded by a line number.

INSERTROW



Description This command will insert a new row into an existing array.

Format `INSERTROW (<ARRAYNAME>, <INDEX>)`

Parameters

<ARRAYNAME> = array where the row will be inserted

<INDEX> = index of the row in the array that the new row will be inserted before



Example • This example shows how to insert a row into the middle of an array.

```
10 DECLARE NUMERIC SCORES(3)
20 LET SCORES(1) = 85
30 LET SCORES(2) = 92
40 LET SCORES(3) = 98
50 INSERTROW(SCORES, 2)
60 LET SCORES(2) = 100
```



Example • This example shows how to add a row into the end of an array.

```
10 DECLARE NUMERIC SCORES(3)
20 LET SCORES(1) = 85
30 LET SCORES(2) = 92
40 LET SCORES(3) = 98
50 INSERTROW(SCORES, 4)
60 LET SCORES(4) = 100
```

Comments Inserting a row increases the size of the array by one row, and moves all the rows from `INDEX` to the end of the array up one row, leaving an empty row at position `INDEX`.

`INDEX` cannot be any larger the number of rows in the array plus one. If the number of rows plus one is provided, the new row will be added to the end of the array.

This can be an interactive command that takes effect as soon as it is received by the printer, or a program command that is preceded by a line number.

DELROW



Description This command will delete a row from an existing array.

Format DELROW (<ARRAYNAME>, <INDEX>)

Parameters

<ARRAYNAME> = the array where the row will be deleted

<INDEX> = index of the row to delete from the array



Example • This example shows how to delete a row from the middle of an array.

```
10 DECLARE NUMERIC SCORES(5)
20 LET SCORES(1) = 85
30 LET SCORES(2) = 92
40 LET SCORES(3) = 98
50 LET SCORES(4) = 45
60 LET SCORES(5) = 100
70 DELROW(SCORES, 4) ! Remove the low score
```

Comments This decreases the size of A by one row, and moves all the rows from INDEX to the end of the array down by one, overwriting the row at position INDEX.

INDEX cannot be any larger the number of rows in the array.

If the array only has one row, that row may not be deleted.

This can be an interactive command that takes effect as soon as it is received by the printer, or a program command that is preceded by a line number.

ROWSIZE



Description This function will return the number of rows in an array.

Format

```
ROWSIZE(A)  
ROWSIZE(A$)
```

Parameters

A = integer array to query for the number of rows.

A\$ = string array to query for the number of rows.

Returns Returns a 0 if the variable is not an array. Returns the number of elements in the array if the array has only one dimension. Returns the size of the first dimension if the array has two dimensions.



Example • This example shows how to determine the number of elements in a one dimensional string array.

```
10 DECLARE STRING NAMES$(3)  
20 LET NAMES$(1) = "Fred"  
30 LET NAMES$(2) = "Wilma"  
40 LET NAMES$(3) = "Barney"  
50 REDIM NAMES$(4) ! Make room for Betty  
60 LET NAMES$(4) = "Betty"  
70 LET NUMOFNAMES = ROWSIZE(NAMES$)  
80 PRINT NUMOFNAMES
```



Example • This example shows how to determine the number of rows in a two dimensional numeric array.

```
10 DECLARE NUMERIC SQROFTWOLOOKUP(3,2)  
20 LET SQROFTWOLOOKUP (1,1) = 1  
30 LET SQROFTWOLOOKUP (1,2) = 2  
40 LET SQROFTWOLOOKUP (2,1) = 2  
50 LET SQROFTWOLOOKUP (2,2) = 4  
60 LET SQROFTWOLOOKUP (3,1) = 3  
70 LET SQROFTWOLOOKUP (3,2) = 8  
80 LET NUMOFSQRS = ROWSIZE(SQROFTWOLOOKUP)  
90 PRINT NUMOFSQRS
```

COLUMNSIZE



Description This function will return the number of columns in an array.

Format

```
COLUMNSIZE(A)  
COLUMNSIZE(A$)
```

Parameters

A = integer array to query for the number of columns.

A\$ = string array to query for the number of columns.

Returns A 0 if the variable is not an array. Returns 1 if the array has only one dimension. Returns the size of the second dimension if the array has two dimensions.



Example • This example shows how to determine the number of elements in a one dimensional string array.

```
10 DECLARE STRING NAMES$(3)  
20 LET NAMES$(1) = "Fred"  
30 LET NAMES$(2) = "Wilma"  
40 LET NAMES$(3) = "Barney"  
50 REDIM NAMES$(4) ! Make room for Betty  
60 LET NAMES$(4) = "Betty"  
70 LET NUMOFCOLS = COLUMNSIZE(NAMES$)  
80 PRINT NUMOFCOLS
```



Example • This example shows how to determine the number of columns in a two dimensional numeric array.

```
10 DECLARE NUMERIC SQROFTWOLOOKUP(3,2)  
20 LET SQROFTWOLOOKUP (1,1) = 1  
30 LET SQROFTWOLOOKUP (1,2) = 2  
40 LET SQROFTWOLOOKUP (2,1) = 2  
50 LET SQROFTWOLOOKUP (2,2) = 4  
60 LET SQROFTWOLOOKUP (3,1) = 3  
70 LET SQROFTWOLOOKUP (3,2) = 8  
80 LET COLCNT = COLUMNSIZE(SQROFTWOLOOKUP)  
90 PRINT COLCNT
```

FIND



Description This function will find an element of a string array that contains an identified search string.

Format

```
FIND(A$, B$)  
FIND(A$, B$, START)  
FIND(A$, COLUMN, B$)  
FIND(A$, COLUMN, B$, START)
```

Parameters

A\$ = string array to search for B\$.

B\$ = string to search for within A\$.

START = index within a single dimensional array, or row for a two dimensional array, to start the search.

COLUMN = column to isolate search to in a two dimensional array. This must be supplied if A\$ is a two dimensional array.

Returns Returns a 0 if B\$ is not found or if there was an error. Otherwise, returns the index that contains the first occurrence of the string B\$ (the element index for one dimensional arrays, the row for two dimensional arrays).



Example • This example shows how to find a string in a one dimensional array.

```
10 DECLARE STRING NAMES$(4)  
20 LET NAMES$(1) = "Fred"  
30 LET NAMES$(2) = "Wilma"  
40 LET NAMES$(3) = "Barney"  
50 LET NAMES$(4) = "Betty"  
60 LET BARNEYIX = FIND(NAMES$, "Bar")  
70 PRINT "Found Barney in element "; STR$(BARNEYIX)
```



Example • This example shows how to find a string that occurs more than once in a two dimensional array.

```
10 DECLARE STRING CLOTHING$(5,2)
20 LET TYPECOL      = 1
30 LET MATERIALCOL = 2
40 LET CLOTHING$(1,1) = "Gloves"
50 LET CLOTHING$(1,2) = "Knit"
60 LET CLOTHING$(2,1) = "Pants"
70 LET CLOTHING$(2,2) = "Cotton"
80 LET CLOTHING$(3,1) = "Gloves"
90 LET CLOTHING$(3,2) = "Leather"
100 LET CLOTHING$(4,2) = "Shirts"
110 LET CLOTHING$(4,2) = "Polyester"
120 LET CLOTHING$(5,2) = "Pants"
130 LET CLOTHING$(5,2) = "Denim"
140 LET GLOVEIX = 1
150 DO
160 LET GLOVEIX = FIND(CLOTHING$, TYPECOL, "Gloves", GLOVEIX)
170 IF NOT GLOVEIX = 0 THEN
180 PRINT CLOTHING$(GLOVEIX, MATERIALCOL), "gloves are available"
190 LET GLOVEIX = GLOVEIX + 1
200 END IF
210 LOOP WHILE NOT GLOVEIX = 0
```

Comments COLUMN must be greater than 0.

If START is given, it must be greater than 0.

FIND will match the first occurrence of B\$, even if it is a substring of a string within the A\$ array. For example, "Coat" will be found in both locations 1 and 4.

```
5 DECLARE STRING A$(5)
10 LET A$(1) = "Over Coat"
20 LET A$(2) = "Hat"
30 LET A$(3) = "Jacket"
40 LET A$(4) = "Coat"
50 LET A$(5) = "Boots"
```

If an exact match is needed, FIND should be called until 0 is returned or the item is found and confirmed. To confirm, check the item against the expected item, it should match exactly. See *CSV Program on page 612* for an example showing how to do this.

Time and Date Functions

This section describes the functions to access the real time clock option. Here is a quick list of these commands:

DATE\$ Returns the date as a string

TIME\$ Returns the current time in a string.

DATE Gets the current date as a number.

TIME Gets the current time as a number.

DATE\$

Description This function returns the date as a string.

Format DATE\$

Parameters N/A

Returns The current date in string form YYYYMMDD. If the Real-Time Clock is not installed, an empty string is returned.



Example • This is an example of how to use the DATE\$ command:

```
10 PRINT DATE$  
RUN
```

The result, assuming the date is January 1, 2003 is:

```
20030101
```

Example • This is another example of the DATE\$ command used with the sub-string operator to get the day of the month:

```
10 LET A$=DATE$(7:8)  
20 IF A$ <> DATE$(7:8)  
30 LET A$=DATE$(7:8)  
40 IF A$="01"  
50 PRINT "IT IS THE FIRST OF THE MONTH"  
60 END IF  
70 END IF  
80 SLEEP 100  
90 GOTO 20
```

Comments None

TIME\$

Description This function returns the current time in a string.

Format TIME\$

Parameters N/A

Returns This function returns the time of day in format HH:MM:SS (hours:minutes:seconds). If the Real-Time Clock is not installed, an empty string is returned.



Example • This is an example of how to use the TIME\$command:

```
10 PRINT TIME$  
RUN  
10:00:00
```

Comments None

DATE

Description This function gets the current date as a number.

Format DATE

Parameters N/A

Returns This function returns the current date in YYYYDDD format, where YYYY is the year and DDD is the number of days since the beginning of the year. If the Real-Time Clock is not installed, 0 is returned.



Example • This example assumes the current date is January 1, 2003:

```
10 PRINT DATE  
RUN  
2003001
```

Comments None

TIME

Description This function gets the current time as a number.

Format TIME

Parameters N/A

Returns This function returns the time past midnight (2400h) in seconds. If the Real-Time Clock is not installed, 0 is returned.



This is an example of how to use the TIME command [assuming the time is one minute past midnight]:

Example •

```
10 PRINT TIME
RUN
60
```

Comments None

Set/Get/Do Interactions

The printer's Set/Get/Do data can be directly accessed via ZBI. For a complete listing of what can be accessed, see *SGD Printer Commands on page 631*, or type the following:

```
! U1 getvar "allcv"
```

Here's a quick list of these commands:

SETVAR Allows the direct setting of printer parameters.

GETVAR\$ Retrieves printer parameters.

SETVAR



Description SETVAR allows the direct setting of printer parameters.

Format SETVAR (PARAM\$, VALUE\$)

Parameters

PARAM\$ = The printer parameter to set.

VALUE\$ = the value to set

Returns Parameter dependent.



Example • This is an example of the SETVAR command:

```
AUTONUM 1,1
LET OUTSTR$ = "Processing"
LET LOOPCTR = 200
LET TIMER5 = 17
LET TMP = REGISTEREVENT(TIMER5, 0, 1000)
DO WHILE LOOPCTR > 0
LET EVT = HANDLEEVENT()
IF EVT = TIMER5 THEN
LET A = SETVAR("device.frontpanel.line2",OUTSTR$)
LET OUTSTR$ = OUTSTR$ & "."
IF LEN(OUTSTR$) >16 THEN
LET OUTSTR$ = "Processing"
END IF
END IF
LET LOOPCTR = LOOPCTR - 1
SLEEP 1
LOOP
LET TMP = UNREGISTEREVENT(TIMER5)
LET A = SETVAR("device.frontpanel.line2", "")
END
```

Comments None

GETVAR\$



Description This function retrieves printer parameters.

Format GETVAR\$ (PARAM\$)

Parameters

PARAM\$ = the printer parameter to get.

Returns The value of the parameter. Refer to *SGD Printer Commands on page 631* for specific parameters.



Example • This is an example of the GETVAR\$ command:

```
AUTONUM 1,1
LET SGDCOUNT = 7
DECLARE STRING SGDQUERY$(2,SGDCOUNT)
LET SGDQUERY$(1,1) = "appl.name"
LET SGDQUERY$(1,2) = "device.printhead.serialnum"
LET SGDQUERY$(1,3) = "internal_wired.ip.addr"
LET SGDQUERY$(1,4) = "internal_wired.ip.netmask"
LET SGDQUERY$(1,5) = "internal_wired.ip.gateway"
LET SGDQUERY$(1,6) = "internal_wired.ip.port"
LET SGDQUERY$(1,7) = "internal_wired.mac_addr"
FOR I = 1 TO SGDCOUNT
LET SGDQUERY$(2,I) = GETVAR$(SGDQUERY$(1,I))
NEXT I
OPEN #1: NAME "ZPL"
PRINT #1: "^XA"
FOR I = 1 TO SGDCOUNT
PRINT #1: "^FO50,";50*I;"^A0N,25,25^FD";SGDQUERY$(1,I);"=";
PRINT #1: SGDQUERY$(2,I);"^FS"
NEXT I
PRINT #1: "^XZ"
```

Comments None

Example Programs

The next section provides example programs of common tasks using ZBI commands.

These programs are also available for download at: <http://www.zebra.com/zbi>

Array Program

This program prompts a user to enter first a name; when it is entered, it is added to an array of all names entered. The user is then prompted to enter an address, which is then added to an array of all addresses entered. After the user enters a total or five names and addresses, the program uses the arrays to print the entered data on five labels.



Example • This is an example of Array

```

1 rem *****
1 rem Zebra Technologies ZBI Sample Program
1 rem
1 rem Professional programming services are available. Please contact
1 rem ZBI-Experts@zebra.com for more information.
1 rem
1 rem This is an example of using arrays to store and use data within 1 rem
ZBI.
1 rem *****
1 rem close all ports except for the console
1 rem*****
10 for i = 1 to 9 step 1
20   close #i
30   next i
1 rem *****
1 rem open a port to the print engine
1 rem *****
40 open #1: name "ZPL"
1 rem *****
1 rem create string arrays five elements in size to hold names and
1 rem addresses
1 rem *****
50 declare string name$(5)
60 declare string address$(5)
1 rem *****
1 rem infinite loop to put name and address data from console into
1 rem arrays
1 rem *****

```

```
70 do
80 for i = 1 to 5 step 1
90   print "PLEASE ENTER THE NAME"
1 rem *****
1 rem get data from console; input command looks for CRLF
1 rem *****
100   input name$(i)
1 rem *****
1 rem if the user inputs end or END, the program will end
1 rem *****
110   if name$(i) = "END" or name$(i) = "end" then
120     end
130   end if
140   print "PLEASE ENTER THE ADDRESS"
150   input address$(i)
160   if address$(i) = "END" or address$(i) = "end" then
170     end
180   end if
190 next i
200 for index = 1 to 5 step 1 ! For loop To Print data no label
1 rem *****
1 rem semicolon at the end prints with no CRLF
1 rem *****
210   print #1: "^XA^F030,30^A0N,30,30^FD"&NAME$(INDEX)&"^FS";
1 rem *****
1 rem ampersand used to concatenate data into strings
1 rem *****
220   print #1: "^F030,70^A0N,30,30^FD"&ADDRESS$(INDEX)&"^FS^XZ"
230 next index
240 loop ! loops back To Line 60
250 end
```

CSV Program

The following program will initialize and then execute continuously, repeating the same series of operations; process events, read input from the serial port, write any processed data out to the ZPL port, and then process the data read from the serial port.

The program first loads the CSV database E:PRODUCTS.CSV (in PROGRAMINIT subroutine). Then, data read from the serial port is compared against the first column in the database. If an entry is found in the first column of a row (in FINDITEM subroutine), the data for the respective row is inserted into the ZPL format E:PRICELBL.ZPL and printed on a label.



Example • This is an example of a CSV program.

```

1 REM SUBROUTINES BELOW...
2 REM
3 REM
*****
4 REM             MAIN LOOP - DO NOT MODIFY
5 REM
*****
6 REM
7 GOSUB PROGRAMINIT
8 DO WHILE 1 = 1
9 GOSUB PROCESSEVENTS
10 GOSUB GETINPUT
11 GOSUB WRITEOUTPUT
12 GOSUB PROCESSDATA
13 LOOP
14 REM SUBROUTINES BELOW...
15 REM
16 REM
*****
17 REM             Program Init
18 REM
*****
19 REM
20 SUB PROGRAMINIT
21 LET INPORT = 1
22 LET OUTPORT = 2
23 LET ENDLINE$ = CHR$ ( 13 ) & CHR$ ( 10 )
24 OPEN # INPORT : NAME "SER"
25 OPEN # OUTPORT : NAME "ZPL"
26 DECLARE STRING DATABASE$ ( 1 , 1 )
27 LET COLUMNCOUNT = CSVLOAD ( DATABASE$ , "E:PRODUCTS.CSV" )
28 LET OUTDATA$ = "TABLE WITH " & STR$ ( COLUMNCOUNT ) & " COLUMNS LOADED" &
ENDLINE$
29 RETURN
30 REM
31 REM

```



Example • This is an example of a CSV program (continued).

```
*****
32 REM          Process Events
33 REM
*****
34 REM
35 SUB PROCESSEVENTS
36 RETURN
37 REM
38 REM
*****
39 REM          Get Input
40 REM
41 REM Writes All Data from the serial port to the string INDATA$
42 REM
*****
43 REM
44 SUB GETINPUT
45 IF LEN ( INDATA$ ) < 5000 THEN
46 LET INCOUNT = READ ( INPORT , A$ , 1024 )
47 LET INDATA$ = INDATA$ & A$
48 END IF
49 RETURN
50 REM
51 REM
*****
52 REM          Write Output
53 REM
54 REM Writes All Data from the string OUTDATA$ to the ZPL Port
55 REM
*****
56 REM
57 SUB WRITEOUTPUT
58 LET OUTCOUNT = WRITE ( OUTPORT , OUTDATA$ , LEN ( OUTDATA$ ) )
59 IF OUTCOUNT > 0 THEN
60 LET OUTDATA$ ( 1 : OUTCOUNT ) = ""
61 END IF
62 RETURN
63 REM
64 REM
```



Example • This is an example of a CSV program (continued).

```

*****
65 REM                               Process Data
66 REM
67 REM Parse the data in the string INDATA$ and write output to OUTDATA$
68 REM
*****
69 REM
70 SUB PROCESSDATA
71 IF LEN ( OUTDATA$ ) > 1000 THEN
72 RETURN
73 END IF
74 REM REMOVE ALL LINE FEEDS
75 DO
76 LET LOC = POS ( INDATA$ , CHR$ ( 10 ) )
77 LET INDATA$ ( LOC : LOC ) = ""
78 LOOP WHILE LOC > 0
79 REM COMPLETED LINE FEED REMOVAL
80 LET LOC = POS ( INDATA$ , CHR$ ( 13 ) ) ! Line ends with CR
81 IF LOC > 0 THEN
82 LET INLINE$ = INDATA$ ( 1 : LOC - 1 )
83 LET INDATA$ ( 1 : LOC ) = ""
84 GOSUB FINDITEM
85 IF ROW > 0 THEN
86 LET OUTDATA$ = OUTDATA$ & "^XA^XFE:PRICELBL.ZPL^FS" & ENDLINE$
87 LET OUTDATA$ = OUTDATA$ & "^FN1^FD" & DATABASE$ ( ROW , 1 ) & "^FS" &
ENDLINE$
88 LET OUTDATA$ = OUTDATA$ & "^FN2^FD" & DATABASE$ ( ROW , 2 ) & "^FS" &
ENDLINE$
89 LET OUTDATA$ = OUTDATA$ & "^FN3^FD" & DATABASE$ ( ROW , 3 ) & "^FS^XZ" &
ENDLINE$
90 END IF
91 END IF
92 RETURN
93 REM
94 REM

```



Example • This is an example of a CSV program (continued).

```
*****
95 REM                      Find Item
96 REM
97 REM Search the first column of the database for the exact item requested
98 REM
*****
99 REM
100 SUB FINDITEM
101 LET ROW = 0
102 LET EXPECTED$ = INLINE$
103 DO
104 LET FOUNDENTRY$ = ""
105 LET ROW = FIND ( DATABASE$ , 1 , EXPECTED$ , ROW + 1 )
106 IF ROW <> 0 THEN
107 LET FOUNDENTRY$ = DATABASE$ ( ROW , 1 )
108 END IF
109 LOOP WHILE ( ROW <> 0 AND FOUNDENTRY$ <> EXPECTED$ )
110 RETURN
```

DPI Conversion Program

This program converts a ZPL format being sent to the printer on the parallel port to 300 dpi (dots per inch) from 200 dpi (dots per inch). This is done by searching for and extracting ZPL commands with resolution-dependent arguments and scaling the arguments for a 300 dpi printer.



Example • This is an example of dpi conversion:

```

1 rem *****
1 rem Zebra Technologies ZBI Sample Program
1 rem
1 rem Professional programming services are available. Please contact
1 rem ZBI-Experts@zebra.com for more information.
1 rem
1 rem This is an example of converting a printer from 200 dpi (dots
1 rem per inch
1 rem to 300 dpi. This example covers only some of the ZPL commands
1 rem that
1 rem could be affected by converting from 200 to 300 dpi printing.
1 rem *****
1 rem open the ports for input and output
1 rem *****
10 close #1
20 close #2
30 open #1 : name "PAR"
40 open #2 : name "ZPL"
1 rem *****
1 rem create an array with the search parameters
1 rem *****
50 declare string find$(20)
60 let find$(1) = "^FO"
70 let find$(2) = "^A0"
80 let find$(3) = "^GB"
90 let find$(4) = "^XZ"
100 let find$(5) = "^A@"
110 let find$(6) = "^LL"
120 let find$(7) = "^LH"
130 let find$(8) = "FO"
140 let find$(9) = "A0"
150 let find$(10) = "GB"
160 let find$(11) = "XZ"
170 let find$(12) = "A@"
180 let find$(14) = "LH"
190 let find$(15) = "^BY"
200 let find$(16) = "BY"
210 let find$(17) = "^B3"
220 let find$(18) = "B3"

```

```
1 rem *****
1 rem search for the parameters
1 rem *****
300 do
310 let in$ = searchto$(1, find$, 2)
1 rem *****
1 rem once a parameter is found, determine how to handle it
1 rem *****
320 if in$ = "^FO" or in$ = "FO" then
330 gosub 520
340 else if in$ = "^LH" or in$ = "LH" then
350 gosub 520
360 else if in$ = "^A0" or in$ = "A0" then
370 gosub 700
380 else if in$ = "^A@" or in$ = "A@" then
390 gosub 700
400 else if in$ = "^GB" or in$ = "GB" then
410 gosub 1100
420 else if in$ = "^LL" then
430 gosub 1300
440 else if in$ = "^BY" or in$ = "BY" then
450 gosub 1400
460 else if in$ = "^B3" or in$ = "B3" then
470 gosub 1600
480 else if in$ = "^XZ" then
490 print #2: in$;
500 end if
510 loop
1 rem *****
1 rem convert the ^FO and ^LH commands from 200 to 300 dpi
1 rem *****
520 inbyte #1: a$
530 let a = ord(a$)
540 if a >= 65 then
550 print #2: in$&a$;
560 goto 660
570 end if
580 let x$ = extract$(1, "", ", ")
590 let x2$ = a$&x$
600 let y$ = extract$(1, "", "^")
610 let x = val(x2$)
620 let y = val(y$)
630 let x2 = (x/2)+x
640 let y2 = (y/2)+y
650 print #2: in$; x2; ","; y2; "^";
660 return
```

```

1 rem *****
1 rem convert the ^A0 and ^A@ commands from 200 to 300 dpi
1 rem *****
700 inbyte #1: a$
710 let a = ord(a$)
720 let b = 0
730 let c = 0
740 if a >= 65 then
750     print #2: in$&a$; ",";
760     let b = 1
770 end if
780 inbyte #1: a$
790 let h$ = extract$(1, "", ",")
800 if in$ = "^A@" or in$ = "A@" then
810     let c = 1
820     let w$ = extract$(1, "", ",")
830     let m$ = extract$(1, "", "^")
840 else
850     let w$ = extract$(1, "", "^")
860 end if
870 let h = val(h$)
880 let w = val(w$)
900 let h2 = (h/2) + h
910 let w2 = (w/2) + w
920 if b = 1 then
930     print #2: h2; ","; w2;
940 else
950     print #2: in$&"N,"; h2; ","; w2;
960 end if
970 if c = 1 then
980     print #2: ","; m$;
990 end if
1000 print #2: "^";
1010 return
1 rem *****
1 rem convert the ^GB command from 200 to 300 dpi
1 rem *****
1020 let w$ = extract$(1, "", ",")
1030 let h$ = extract$(1, "", ",")
1040 let t$ = extract$(1, "", "^")
1050 let h = val(h$)
1060 let w = val(w$)
1070 let t = val(t$)
1080 let h2 = (h/2)+ h
1090 let w2 = (w/2)+ w
1100 let t2 = (t/2)+ t
1110 print #2: in$; w2; ","; h2; ","; t2; "^";
1120 return

```

```
1 rem *****
1 rem convert the ^LL command from 200 to 300 dpi
1 rem *****
1300 let l$ = extract$(1, "", "^")
1310 let l = VAL(l$)
1320 let l2 = (l/2) + 1
1330 print #2: in$; l2; "^";
1340 return
1 rem *****
1 rem convert the ^BY command from 200 to 300 dpi
1 rem *****
1400 inbyte #1: a$
1410 let a = ord(a$)
1420 if a >= 48 and a <= 57 then
1460   let x$ = extract$(1, "", ", ")
1470   let x2$ = a$&x$
1480   let x = val(x2$)
1490   let x2 = (x/2) + x
1500   if x2 > 10 then
1510     let x2 = 10
1520   end if
1530   print #2: in$; x2; ",";
1540 else
1550   print #2: in$; a$;
1560 end if
1570 return
1 rem *****
1 rem convert the ^B3 command from 200 to 300 dpi
1 rem *****
1600 let o$ = extract$(1, "", ", ")
1610 let e$ = extract$(1, "", ", ")
1620 let h$ = extract$(1, "", ", ")
1630 let h = val(h$)
1640 let h2 = (h/2) + h
1650 print #2: in$; o$; ","; e$; ","; h2; ",";
1660 return
```

Email Program

This program sends a simple email message to user@domain.com, assuming a valid email server is set up by identifying the SMTP server on the print server. In order to write email via ZBI, the port written to must be named "EML".



Example • This is an example of email

```

1 rem *****
1 rem Zebra Technologies ZBI Sample Program
1 rem
1 rem Professional programming services are available. Please contact
1 rem ZBI-Experts@zebra.com for more information.
1 rem
1 rem This is an example of connecting to an email server to send
1 rem email.
1 rem *****
1 rem EOT$ is the special character used to denote end of transmission
1 rem *****
5 let EOT$ = chr$(4)
1 rem *****
1 rem Open a connection to the email port; if there is an error, try
1 rem again
1 rem *****
10 open #1: name "EML"
15 on error goto 10
1 rem *****
1 rem Specify address to send message to, signal end of recipients
1 rem with EOT$
1 rem Note: To send to multiple addressees, separate addressees with
1 rem a space
1 rem *****
20 print #1: "user@domain.com";EOT$;
1 rem *****
1 rem Fill in the message information
1 rem *****
30 print #1: "From: Sample User"
40 print #1: "To: Recipient"
50 print #1: "Subject: This is a test"
60 print #1: ""
70 print #1: "Hello!"
80 print #1: i
1 rem *****
1 rem Terminate message
1 rem *****
90 print #1: "";EOT$
1 rem *****
1 rem Close the port, since each open port is only good for sending
1 rem one message
1 rem *****
100 close #1
110 sleep 2
120 let i = i + 1
130 goto 10

```

Extraction 1 Program

This program finds and stores data of interest, which in this case is found in a format after the string "DATA = ". The extract command is used to get the data from the input stream, and it is inserted into a simple ZPL format to be printed.



Example • This is an example of Extraction 1.

```

1 rem *****
1 rem Zebra Technologies ZBI Sample Program
1 rem
1 rem Professional programming services are available. Please contact
1 rem ZBI-Experts@zebra.com for more information.
1 rem
1 rem This is an example of using ZBI for data extraction.
1 rem There are two methods for doing extraction; this example shows
1 rem data extraction using a string.
1 rem
1 rem The data to extract is as follows:
1 rem START
1 rem DATA = "hello":
1 rem DATA = "goodbye":
1 rem END
1 rem *****
1 rem close ports except console, open channels to parallel and serial
1 rem ports
1 rem *****
05 for i = 1 to 9 step 1
10   close #i
20 next i
30 open #1: name "PAR"
40 open #2: name "ZPL"
1 rem *****
1 rem create string array to hold data
1 rem *****
50 declare string format$(3)
60 let format$(1) = "START"
70 let format$(2) = "END"
80 let format$(3) = "DATA"
1 rem *****
1 rem main program; look for "START" keyword, if found print ^XA to ZPL port
1 rem *****
90 do
100   let begin$ = searchto$(1,format$,2)
110   if begin$ = "START" then
120     print #2: "^XA";

```

```

1 rem *****
1 rem if "DATA" keyword is found, get two data strings
1 rem *****
130   else if begin$ = "DATA" then
140     input #1: data_string1$
150     input #1: data_string2$
1 rem *****
1 rem get data from between quotes and print to ZPL port with formatting
1 rem *****
160     let extracted_data1$ = extract$(data_string1$, "\"", "\"")
170     let extracted_data2$ = extract$(data_string2$, "\"", "\"")
180     print #2:"^F030,30^A0N,30,30^FD"&extracted_data1$&"^FS";
190     print #2:"^F030,70^A0N,30,30^FD"&extracted_data2$&"^FS";
200   else if begin$ = "END" then
210     print #2: "^XZ"
220   end if
230 loop

```

Extraction 2 Program

This program finds and stores data of interest, which in this case is found in a format after the string "DATA = ". The input command is used to get the data from the input stream, and it is inserted into a simple ZPL format to be printed.



Example • This is an example of Extraction 2.

```

1 rem*****
1 rem Zebra Technologies ZBI Sample Program
1 rem
1 rem Professional programming services are available. Please contact
1 rem ZBI-Experts@zebra.com for more information.
1 rem
1 rem This is an example of using ZBI for data extraction.
1 rem There are two methods for doing extraction; this example shows
1 rem data extraction from the port directly.
1 rem
1 rem The data to extract is as follows:
1 rem START
1 rem DATA = "hello":
1 rem DATA = "goodbye":
1 rem END
1 rem*****
1 rem close ports except console, open channels to parallel and serial ports
1 rem*****
05 for i = 1 to 9 step 1
10   close #i
20 next i
30 open #1: name "PAR"
40 open #2: name "ZPL"
1 rem*****
1 rem create string array to hold data
1 rem*****quotes and print to ZPL port with formatting
1 rem*****

```

```
50 declare string format$(3)
60 let format$(1) = "START"
70 let format$(2) = "END"
80 let format$(3) = "DATA"
1 rem*****
1 rem main program; look for "START" keyword, if found print ^XA to ZPL port
1 rem*****
90 do
100   let begin$ = searchto$(1, format$, 2)
110   if begin$ = "START" then
120     print #2: "^XA";
1 rem*****
1 rem if "DATA" keyword is found, get two data strings
1 rem*****
130   else if begin$ = "DATA" then
1 rem*****
1 rem get data from between q
140     let extracted_data1$ = extract$(1,"","")
150     input #1: junk$
170     let extracted_data2$ = extract$(1,"","")
180     print #2:"^F030,30^A0N,30,30^FD" &extracted_data1$& "^FS";
190     print #2:"^F030,70^A0N,30,30^FD" &extracted_data2$& "^FS";
200   else if begin$ = "END" then
210     print #2: "^XZ"
220   end if
230 loop
```

Front Panel Control

This example shows how to intercept front panel button presses and write to the display to create a simple menu. The buttons used in this demo are set up for a Z4M/Z6M, ZM400/ZM600, or RZ400/RZ600. This could be reconfigured to work with any other printer.



Example • This is an example of front panel control.

```
1 REM This example shows how to override the functionality of the feed key
1 REM and use the front panel display to show a option list
AUTONUM 1,1
REM CLOSE ALL
DECLARE STRING OPTIONS$(5)
FOR I = 1 TO 5
LET OPTIONS$(I) = "Option " & STR$(I)
NEXT I
LET ZPLPORT = 1
OPEN #ZPLPORT: NAME "ZPL"
LET FEEDKEY = 3
LET SELECTKEY = 10
LET PLUSKEY = 6
LET MINUSKEY = 7
LET EXITKEY = 9
LET TMP = REGISTEREVENT(FEEDKEY, 0, 1)
SUB NORMALLOOP
DO WHILE 1 = 1
LET EVT = HANDLEEVENT()
IF EVT = FEEDKEY THEN
LET INDEX = 1
GOSUB REGISTERKEYS
GOSUB SHOWMENU
GOTO FEEDLOOP
END IF
SLEEP 1
LOOP
SUB FEEDLOOP
DO WHILE 1 = 1
LET EVT = HANDLEEVENT()
IF EVT = FEEDKEY THEN
GOSUB RELEASEKEYS
GOSUB HIDEMENU
GOTO NORMALLOOP
ELSE IF EVT = SELECTKEY THEN
GOSUB HANDLEOPTION
ELSE IF EVT = PLUSKEY THEN
LET INDEX = INDEX + 1
IF INDEX > 5 THEN
LET INDEX = 1
END IF
```

```
GOSUB SHOWMENU
ELSE IF EVT = MINUSKEY THEN
LET INDEX = INDEX - 1
IF INDEX < 1 THEN
LET INDEX = 5
END IF
GOSUB SHOWMENU
ELSE IF EVT = EXITKEY THEN
GOSUB RELEASEKEYS
GOSUB HIDEMENU
GOTO NORMALLOOP
END IF
SLEEP 1
LOOP
REM ***** SUBROUTINE SHOWMENU ***
SUB SHOWMENU
LET LINE1$ = "FEED DISPLAY"
LET LINE2$ = OPTIONS$(INDEX)
GOSUB UPDATEDISPLAY
RETURN
REM ***** SUBROUTINE HIDEMENU ***
SUB HIDEMENU
LET LINE1$ = ""
LET LINE2$ = ""
GOSUB UPDATEDISPLAY
RETURN
SUB UPDATEDISPLAY
LET A = SETVAR("device.frontpanel.line1",LINE1$)
LET A = SETVAR("device.frontpanel.line2",LINE2$)
RETURN
SUB REGISTERKEYS
LET TMP = REGISTEREVENT(SELECTKEY, 0, 1)
LET TMP = REGISTEREVENT(PLUSKEY, 0, 1)
LET TMP = REGISTEREVENT(MINUSKEY, 0, 1)
LET TMP = REGISTEREVENT(EXITKEY, 0, 1)
RETURN
SUB RELEASEKEYS
LET TMP = UNREGISTEREVENT(SELECTKEY)
LET TMP = UNREGISTEREVENT(PLUSKEY)
LET TMP = UNREGISTEREVENT(MINUSKEY)
LET TMP = UNREGISTEREVENT(EXITKEY)
RETURN
SUB HANDLEOPTION
PRINT #ZPLPORT: "^XA^F0100,100^A0N,100,100^FD"; OPTIONS$(INDEX);"^XZ"
RETURN
```

Recall Program

This program searches for a ZPL format named "FORMAT.ZPL" that is already saved in printer memory. If the format is found, a number within the format is extracted and shown on the console. The user is then prompted to enter a new number, which is then substituted into the format.



Example • This is an example of Recall.zpl

```

1 rem *****
1 rem Zebra Technologies ZBI Sample Program
1 rem
1 rem Professional programming services are available. Please contact
1 rem ZBI-Experts@zebra.com for more information.
1 rem
1 rem This is an example of recalling a ZPL format and extracting data
1 rem from it.
1 rem *****
1 rem close ports except console, open ZPL port and declare search
1 rem array
1 rem *****
10 for i = 1 to 9 step 1 ! Close all ports
20   close #i
30 next i
40 let zplport = 2
50 open #zplport: name "ZPL"
60 declare string search_zpl$(2)
70 let search_zpl$(1) = chr$(03)
80 let search_zpl$(2) = "FORMAT.ZPL"
1 rem *****
1 rem main program; look for format to recall on printer
1 rem *****
90 do
100  print #zplport: "^XA^HWE:*.ZPL^FS^XZ"
110    let present = 0
115  let find$ = ""
120  do until find$ = chr$(03)
130    let find$ = searchto$(zplport, search_zpl$)
140    if find$ = "FORMAT.ZPL" then
150      let present = 1 ! format is present
160    end if
170  loop

```

```
1 rem *****
1 rem if format is not found, create a format and set data value to
1 rem 000
1 rem *****
180   if present = 0 then
190     print #zplport:"^XA^DFE:FORMAT.ZPL^FS";
200     print #zplport:"^FX000^FS^XZ"
210     let counter$ = "000"
1 rem *****
1 rem if format is found, extract the data from ^FX field
1 rem *****
220   else
230     print #zplport:"^XA^HFE:FORMAT.ZPL^FS^XZ"
240     let stop$ = searchto$(zplport, "^FX")
250     let counter$ = extract$(zplport, "", "^FS")
260     let stop$ = searchto$(zplport, "^XZ")
270   end if
1 rem *****
1 rem print current data value, prompt user to replace data
1 rem *****
280   print ""
290   print "Current number in format is " & counter$
300   print "Please enter new number (type EXIT to end) ";
310   input new_counter$
320   if new_counter$ = "EXIT" then
330     print "Program ending"
340     end
350   else
360     print #zplport:"^XA^DFE:FORMAT.ZPL^FS";
370     print #zplport:"^FX" & new_counter$ & "^FS^XZ"
380   end if
390 loop
```

Scale Program

This program reads data from a scale connected to the serial port by sending a "W" to the scale and waiting for a weight to be returned. When the weight is received, it is inserted into a simple label format and printed.



Example • This is an example of Scale

```

1 rem *****
1 rem Zebra Technologies ZBI Sample Program
1 rem
1 rem Professional programming services are available. Please contact
1 rem ZBI-Experts@zebra.com for more information.
1 rem
1 rem This is an example of using ZBI to read scale data from the
1 rem serial port.
1 rem *****
1 rem close all ports except console, open channels to parallel and
1 rem serial ports
1 rem *****
05 for i = 1 to 9 step 1
10   close #i
20   next i
30 open # 2 : name "SER"
40 open # 1 : name "ZPL"
1 rem *****
1 rem main program; send serial port a 'W' in order to get a weight
1 rem *****
50 do
60   do
70     sleep 1   ! sleep so scale is not bombarded with incoming
1 rem data
80     print # 2 : "W" ;   ! semicolon ends sent W without a CRLF
1 rem *****
1 rem get response from scale; note that input requires a CRLF to be
1 rem entered
1 rem *****
90   input # 2 : a$
100  if a$ = "EXIT" then! back door exit - if EXIT is received, ZBI ends
110    close # 2
120    print #1: "^XZ"
130    close #1
140    end
150  end if

```



```
1 rem *****
1 rem loop until valid weight is received, then print on label
1 rem *****
160 loop while pos ( a$ , "000.00" ) = 1 or pos ( a$ , "?" ) = 1
170 print # 1 : "~SD25^XA^FS";
180 print # 1 : "^LH0,0^FS";
190 print # 1 : "^F056,47^A0N,69,58^FDThis weighs^FS";
1 rem *****
1 rem print weight on label; & character concatenates strings
1 rem *****
200 print # 1 : "^F056,150^A0N,69,58^FD" & A$ & " lbs^FS";
210 print # 1 : "^PQ1,0,0,N";
220 print # 1 : "^XZ"
1 rem *****
1 rem loop until weight is off scale, then repeat for next item
1 rem weighed
1 rem *****
230 do
240     print # 2 : "W" ;
250     input # 2 : A$
260 loop until pos(A$ , "000.00") = 1 or pos(A$ , "?") = 1
270 loop
```



Notes • _____

SGD Printer Commands

This chapter provides a high-level overview of printer setting Set / Get / Do (SGD) commands. For printer support of these SGD commands, see [SGD Command Support on page 1267](#).



SGD commands are available in printers with the following firmware versions or later:

- V66.17.4Z or later
- V61.15.xZ or later
- V60.16.2Z or later
- V60.15.xZ or later
- V50.15.xZ or later
- V56.15.xZ or later
- V53.16.x or later
- V53.15.2Z or later
- R53.16.3Z or later
- R60.15.8Z or later
- R62.15.8Z or later
- R63.15.8Z or later
- R65.15.8Z or later



Important • These are important points to note when using ZPL and SGD commands:

- SGD commands are case-sensitive.
- ZPL and SGD commands should be sent to the printer as separate files.
- Certain settings can be controlled by both ZPL and SGD. Configuration changes made in ZPL can affect configuration changes made in SGD.
- Changes made with one command type (ZPL or SGD) will affect the data returned to the host in response to both ZPL and getvar commands. The command type (ZPL or SGD) that was sent last determines the current setting.
- Some RF cards do not support all of the SGD commands.



Important • These are important points to note when using a Zebra G-Series printer:

- You can send instructions to the printer using multiple programming languages: EPL, ZPL, or SGD. EPL and ZPL commands configure the printer, print labels, and get device status information. SGD commands set and get configuration details. These three languages can be used without the need to send the printer instructions to switch from one language to another.
- EPL, ZPL, and SGD commands must be sent to the printer as separate files. They cannot be used together in one format, or set of commands. For example, if you send a series of SGD commands to the printer and they are followed by a printable format, this needs to be done using separate files.

Overview

This section describes how and why to use the Set / Get / Do (SGD) commands. It also provides an example of a typical command structure.



Note • SGD commands must be terminated by a carriage return or a space and line feed.

SGD commands are commands that allow you to configure all printers with firmware versions V60.15.xZ, V50.15.xZ, V61.15.xZ, V56.15.xZ, V53.15.xZ, or later. The printer performs the specified function immediately after receiving the command. The commands are:

- **setvar**
- **getvar**
- **do**

setvar Command

Setvar commands:

- are used to configure printer settings to specific values by setting them in the printer
- must be terminated by a space character or a CR/ LF (0x0D, 0x0A)



Important • The setvar command and attributes must be specified in lower case.

getvar Command

Getvar commands:

- are used to get the current value of the printer settings
- must be terminated by a space character or CR/LF (0x0D, 0x0A)

The printer responds with the printer setting of “?” if:

- the printer setting does not exist (usually due to incorrect spelling of the printer setting)
- it has not been configured yet



Important • The printer settings and attributes must be specified in lower case.

do Command

Do commands:

- are used to instruct the printer to perform predefined actions
- must be terminated by a space character or a CR/LF (0x0D, 0x0A)

Some **Do** commands require additional settings which must be enclosed in double quotes.



Important • The values must be specified in lower case.

Command Structure

It is important to understand the structure of the command and its components. A command structure illustration is provided for each command in this guide.

→ **Example** • This is an example of a command structure illustration:

```
! U1 setvar "ip.addr" "value"
  1         2         3
```

1	Command—always preceded with an exclamation point (!) and must be specified in lower case. A space resides between the ! and U1 and between U1 and the command (setvar or getvar).
2	Attribute—always in double quotes and must be specified in lower case.
3	Chosen value—always in double quotes. Only applicable for setvar and do .

This command must be terminated by a space character or a CR/ LF (0x0D, 0x0A).

How to Send Multiple SGD Commands

For any **getvar**, **setvar**, or **do** command, if you issue the syntax without the "1" and use the END command followed by a space, multiple SGD commands are sent simultaneously.

→ **Example** • This syntax shows how you can send multiple **getvar** commands:

```
1 → ! U getvar "ip.telnet.enable"
2 → | getvar "ip.dhcp.enable"
   | getvar "ip.dhcp.cid_prefix"
3 → | END
```

1	The command portion of the string does not use the "1" after the "! U".
2	Commands issued after the first command do not require the "! U".
3	The string of commands is terminated by the word "END" with a space after the word, and by a carriage return/ line feed.

JSON (JavaScript Object Notation)

JSON (JavaScript Object Notation) is an open standard format that uses human- and machine-readable text for device management. It transmits data objects consisting of elements as attribute–value pairs.

You can use JSON as an alternative to using the SGD (Set-Get-Do) mechanism when reading or writing parameters on QLn and iMZ mobile printers. JSON is a popular open standard for exchanging data objects and is well suited to this task.

The main settings channel for JSON is TCP port 9200, but other ports can be used. JSON commands are processed when received. Up to eight connections are allowed, and all connected ports are active, and the JSON commands will work while the printer is printing.

The port used for JSON can be changed or disabled using *ip.port_json_config* on page 1058.



Note • JSON is available on all communications ports, unless `line_print` is enabled, in which case you must use the main TCP JSON port, 9200. If you connect to port 9200, the printer ONLY accepts JSON commands. CPCL, SGD, ZPL, and other command languages are not supported.

Configuring JSON Usage for Communications

All JSON commands should follow the JSON specification for escaping, spacing, etc. All JSON commands are prefixed by `{}`. Refer to <http://www.json.org/> for full details on JSON formatting.

By enclosing a variable's value in curly braces, it indicates that the value is an object. Inside the object, you can declare any number of properties using a `"name": "value"` pairing, separated by colons. Multiple pairings are separated by commas.

Use the SGD variable name in the JSON command structure.

To configure JSON usage for communication, refer to the following examples.

Getvar using JSON



Example 1 • To do a getvar in SGD you use the format:

```
! U1 getvar "sgd.name"  
! U1 getvar "ip.port"  
! U1 getvar "device.location"
```

To get a variable value using JSON:

```
{{"sgd.name":null} returns {"sgd.name":"value"}  
{{"ip.port":null} returns {"ip.port":"9100"}  
{{"device.location":null} returns {"device.location":"my desk"}
```

➔ **Example 2** • You can get several values as follows:

```
{{"device.friendly_name":null, "device.company_name":null,
"device.company_contact":null, "device.location":null}}
```

The response is:

```
{"device.friendly_name":"XXQLJ120900310",
"device.company_name":"Zebra Technologies",
"device.company_contact":"123-555-1212",
"device.location":"My Desk"}
```

Setvar using JSON

➔ **Example 1** • To do a setvar in SGD you use the format:

```
! U1 getvar "sgd.name" "value"
! U1 getvar "ip.port" "9200"
! U1 setvar "device.location" "my desk"
```

To set a variable value using JSON:

```
{{"sgd.name":"value"} sets the variable value to "value"
{"ip.port":"1234"} sets the variable value to "1234"
{"device.location":"my desk"} sets the variable value to "my desk"
```



Note • When you set an SGD value, it will return the value that was set, or the old value if the set failed. If:

```
{{"sgd.name":"new_value"} fails, the variable value remains "old_value"
```

➔ **Example 2** • To set several values at once:

```
{{"device.friendly_name":"XXQLJ120900310",
"device.company_contact":"123-555-1212", "device.location":"My Desk"}}
```

The response is:

```
{"device.friendly_name":"XXQLJ120900310",
"device.company_contact":"123-555-1212", "device.location":"My Desk"}
```

Get an SGD Branch

You can retrieve all branch values by specifying the branch.

➔ **Example** •

```
{{"bluetooth":null} returns all SGDs in branch and their values.
```

Get an allvalues Report

You can request an **allvalues** report with just the values for all settings with characteristics. This will return all SGDs and their values.



Example •

```
{ "allvalues":  
  { "ip.port": "6101", "ip.port_alternate": "9100", "ip.sgd_json_port": "9200",  
    ...  
  }  
}
```

Get an allconfig Report

You can request an allconfig report using JSON, and it will return all settings with characteristics.



Example 1 • To get all SGDs and their values along with various other information including defaults:

```
{ "allconfig": null }
```



Note • For the "allconfig" response, it will start with

```
{ "allconfig": {  
  and end with  
}}
```

➔ **Example 2** • If you do an `allconfig`, you can get the setting attributes for all settings as follows:

```
{ "allconfig": { "ip.port": { "value": "6101", "type": "integer", "range": "0- 65535", "clone": true,
"archive": true, "access": "RW" },
"ip.port_alternate": { "value": "9100", "type": "integer", "range": "0-65535", "clone": true,
"archive": true, "access": "RW" },
"ip.sgd_json_port": { "value": "9200", "type": "integer", "range": "0- 65535", "clone": true,
"archive": true, "access": "RW" }, another setting, ... the last setting}}
```

where:

- `"value"` = indicates the current value stored in the setting.
- `"type"` = indicates the type of value. Possible values are integer, enum, bool, string, double, ipv4-address, ipv6- address.
- `"range"` = indicates the range of a setting. For strings this is the range of the string length. For enums it is the possible enum values.
- `"clone"` = indicates if it is safe to store this setting and apply it to another link-os printer.
- `"archive"` = indicates if is safe to store this setting and apply it to same link-os printer at a later time.
- `"acces"` = indicates if the setting is RW (read/write), R (read-only), or W (write-only).

➔ **Example 3** • If you do an `allconfig`, you can get the setting attributes for all settings as follows:

```
{ } { "allconfig": null }
```

For the values used above it returns these entries:

```
"device.friendly_name": { "value": "XXQLJ120900310", "type": "string", "range":
"0-17", "clone": false, "archive": true, "access": "RW" },
"device.company_contact": { "value": "123-555-1212", "type": "string", "range":
"0-128", "clone": true, "archive": true, "access": "RW" },
"device.location": { "value": "my desk", "type": "string", "range": "
0-128", "clone": true, "archive": true, "access": "RW" },
```

alerts.add

Description This command is used to configure the ZebraNet Alert System. It allows Zebra software to add new alerts without having to use the ZPL `^SX` command. This allows software to configure printers which do not have ZPL on them, and it provides the software with a single way in for configuring alerts. It also allows the software to configure alerts via local ports such as USB and serial.

The format is similar to the `^SX` command. It can delete the alert when both the set and clear flags are set to `FALSE`.

Supported Devices

- iMZ 220™, iMZ 320™
- QLn220™, QLn320™, QLn420™
- ZT210™, ZT220™, ZT230™

Type `setvar`, `do`

Commands	Details
<code>setvar</code>	<p>This command instructs the printer to add the new alert with the configuration specified in the comma delimited list.</p> <p>The parameter is a comma delimited list of the following:</p> <ul style="list-style-type: none"> • The alert condition. This can be any of the values returned from alerts.conditions on page 642. • The alert destination type. This can be any of the value returned from alerts.destinations on page 644. • On Set - Set to Y if the alert should be sent when the event is set • On Clear - Set to Y if the alert should be sent when the event is cleared • Destination address - applies to TCP,UDP,EMAIL,SNMP, SDK, and HTTP POST destination types. The maximum length of this address is 255 characters. • Port - Applies to TCP and UDP types • Quelling - When set to "Y" it prevents the alert from being sent. "N" is the default. • SGD Name - the name of the SGD command to be added. This is valid only when the alert condition is <code>SGD_SET</code>. <p><i>Format:</i> <code>! U1 setvar "alerts.add" "[condition],[destination],[set],[clear],[destination_address],[port],[quelling],[SGD_name]"</code></p> <p><i>Values:</i> Defined via alerts.conditions on page 642: PAPER OUT, RIBBON OUT, HEAD TOO HOT, HEAD COLD, HEAD OPEN, SUPPLY TOO HOT, RIBBON IN, REWIND, CUTTER JAM, MED, PRINTER PAUSED, PQ JOB COMPLETED, LABEL READY, HEAD ELEMENT BAD, BASIC RUNTIME, BASIC FORCED, POWER ON, CLEAN PRINTHEAD, MEDIA LOW, RIBBON LOW, REPLACE HEAD, BATTERY LOW, RFID ERROR, ALL MESSAGES, COLD START, SGD SET</p> <p><i>Default:</i> NA</p>
<code>do</code>	<p>This command has the same functionality as the <code>setvar</code>.</p> <p><i>Format:</i> <code>! U1 do "alerts.add" "[condition],[destination],[set],[clear],[destination_address],[port],[quelling],[SGD_name]"</code></p>



Example • This example shows a "Paper Out" alert sent via the serial port, with no destination address specified.

```
! U1 setvar "alerts.add" "PAPER OUT,SERIAL,Y,N,,0,,,"
```



Note •

- For printer support, see [SGD Command Support on page 1267](#).
- For details on SGD command structure, see [Command Structure on page 635](#).

alerts.conditions

Description This command lists the available conditions that can be specified in the first parameter of the `alerts.add` SGD. See [alerts.add on page 640](#) for information on the various parameters.

Supported Devices

- iMZ 220™, iMZ 320™
- QLn220™, QLn320™, QLn420™
- ZT210™, ZT220™, ZT230™

Type `getvar`

Commands	Details
<code>getvar</code>	<p>This command retrieves the list of available alert conditions for the printer.</p> <p><i>Format:</i> ! U1 <code>getvar "alerts.conditions"</code></p> <p><i>Values:</i> PAPER OUT, RIBBON OUT, HEAD TOO HOT, HEAD COLD, HEAD OPEN, SUPPLY TOO HOT, RIBBON IN, REWIND, CUTTER JAM, MED, PRINTER PAUSED, PQ JOB COMPLETED, LABEL READY, HEAD ELEMENT BAD, BASIC RUNTIME, BASIC FORCED, POWER ON, CLEAN PRINthead, MEDIA LOW, RIBBON LOW, REPLACE HEAD, BATTERY LOW, RFID ERROR, ALL MESSAGES, COLD START, SGD SET</p> <p><i>Default:</i> ""</p>



Note •

- For printer support, see [SGD Command Support on page 1267](#).
- For details on SGD command structure, see [Command Structure on page 635](#).

alerts.configured

Description This command creates a list of all the alerts that are configured on the printer. The alerts are delimited by the '|' character.



Important • Writing to this SGD will clear out the old alerts and setup the new ones.

Supported Devices

- iMZ 220™, iMZ 320™
- QLn220™, QLn320™, QLn420™
- ZT210™, ZT220™, ZT230™

Type setvar, getvar

Commands	Details
setvar	<p>This command creates the list of alerts configured on the printer.</p> <p><i>Format:</i> ! U1 setvar "alerts.configured" "<a ' ' delimited list of configured alerts>"</p> <p><i>Values:</i> A list of alerts to be setup on the printer. See alerts.add for the format of the individual alerts.</p> <p><i>Default:</i> "COLD START,SNMP,Y,N,255.255.255.255,162,N"</p>
getvar	<p>This command retrieves the currently configured alerts on the printer.</p> <p><i>Format:</i> ! U1 getvar "alerts.configured"</p>



Note •

- For printer support, see [SGD Command Support on page 1267](#).
- For details on SGD command structure, see [Command Structure on page 635](#).

alerts.destinations

Description This command lists the available destinations that can be specified in the first parameter of the `alerts.add` SGD. See the [alerts.add on page 640](#) for information on the various parameters.

Supported Devices

- iMZ 220™, iMZ 320™
- QLn220™, QLn320™, QLn420™
- ZT210™, ZT220™, ZT230™

Type `getvar`

Commands	Details
<code>getvar</code>	This command returns a comma-delimited list of available alert destinations. <i>Format:</i> ! U1 <code>getvar "alerts.destinations"</code> <i>Values:</i> SERIAL, PARALLEL, E-MAIL, TCP, UDP, SNMP, USB, HTTP-POST, BLUETOOTH, SDK <i>Default Value:</i> NA



Note •

- For printer support, see [SGD Command Support on page 1267](#).
- For details on SGD command structure, see [Command Structure on page 635](#).

alerts.http.authentication.add

Description This command allows the user to add a single server/username/password triplet into the list of authentication entries.

When the printer attempts to connect to the URL in the HTTP POST alert, the server may require HTTP authentication (such as digest, basic, DNS, etc.). There may be multiple authentication requests along the route to the destination (for example, a local server first requires HTTP authentication as well as on the remote server). For each HTTP authentication request received while attempting to connect, the printer will enumerate the authentication entries and attempt to satisfy the request with the username/password pair provided for the respective server. The server name in the entry is what determines which username/password pair should be used for which authentication request. Both DNS names and IP addresses are acceptable.

The server, username, and password are separated by a single space (not a tab or other white space character). The server name is the only required field. If no username is supplied, but a password is, there must be two spaces between the server and the password fields. If there is a username but no password, or simply just the servername, no space is required at the end of the entry.

Supported Devices

- iMZ 220™, iMZ 320™
- QLn220™, QLn320™, QLn420™
- ZT210™, ZT220™, ZT230™

Type setvar, do

Commands	Details
setvar	This command adds server/username/password triplet into the list of authentication entries. <i>Format:</i> ! U1 setvar "alerts.http.authentication.add" "servername[username][password]" <i>Values:</i> Maximum string of 2048 characters. <i>Default:</i> NA
do	This command has the same settings as the setvar. <i>Format:</i> ! U1 do"alerts.http.authentication.add" "servername[username][password]" <i>Values:</i> Maximum string of 2048 characters. <i>Default:</i> NA



Example 1 • A username and a password is supplied:

```
! U1 setvar "alerts.http.authentication.add" "my.server.lan johndoe password"
```



Example 2 • No password is supplied:

```
! U1 setvar "alerts.http.authentication.add" "my.server.lan johndoe"
```

alerts.http.authentication.addalerts.http.authentication.add



Example 3 • No username is supplied (note the double space):

```
! U1 setvar "alerts.http.authentication.add" "my.server.lan password"
```



Example 4 • No username or password is supplied:

```
! U1 setvar "alerts.http.authentication.add" "my.server.lan"
```



Note •

- For printer support, see [SGD Command Support on page 1267](#).
- For details on SGD command structure, see [Command Structure on page 635](#).
- For details on HTTP POST, see [HTTP POST Alerts on page 1369](#).

alerts.http.authentication.entries

Description This command lists the server names added to the authentication entries list via `alerts.http.authentication.add`.

Only the server names will be shown; the username and passwords will not be shown. The server names are separated by a `\r\n` so that each shows up on its own line and is easier to read.

Supported Devices

- iMZ 220™, iMZ 320™
- QLn220™, QLn320™, QLn420™
- ZT210™, ZT220™, ZT230™

Type `getvar`

Commands	Details
<code>getvar</code>	<p>This command lists the server names added to the authentication entry list.</p> <p><i>Format:</i> <code>! U1 getvar "alerts.http.authentication.entries"</code></p> <p><i>Values:</i> A list of server names.</p> <p><i>Default:</i> NA</p>



Note •

- For printer support, see [SGD Command Support on page 1267](#).
- For details on SGD command structure, see [Command Structure on page 635](#).
- For details on HTTP POST, see [HTTP POST Alerts on page 1369](#).

alerts.http.authentication.remove

Description This command allows the user to remove a single server/username/password triplet from the list of authentication entries. To remove an entry, only the server name is supplied, and the entire entry will be removed. If an invalid entry is supplied no action is taken.

Note that the list of authentication triplets will be updated (and saved over a reset) but this SGD is just a command and doesn't have state. Therefore the persistent and restore defaults do not apply. The internal list that this command removes from, however, is persistent and defaultable (defaults to an empty list).

Supported Devices

- iMZ 220™, iMZ 320™
- QLn220™, QLn320™, QLn420™
- ZT210™, ZT220™, ZT230™

Type setvar, do

Commands	Details
setvar	This command removes a server/username/password triplet into the list of authentication entries. <i>Format:</i> ! U1 setvar "alerts.http.authentication.remove" "servername" <i>Values:</i> Maximum string of 2048 characters. <i>Default:</i> NA
do	This command has the same settings as the setvar. <i>Format:</i> ! U1 do "alerts.http.authentication.remove" "servername" <i>Values:</i> Maximum string of 2048 characters. <i>Default:</i> NA



Example • A username and a password is supplied

```
! U1 setvar "alerts.http.authentication.remove" "my.server.lan"
```



Note •

- For printer support, see [SGD Command Support on page 1267](#).
- For details on SGD command structure, see [Command Structure on page 635](#).
- For details on HTTP POST, see [HTTP POST Alerts on page 1369](#).

alerts.http.logging.clear

Description This command clears the weblink alerts log entries. It does not disable logging. Setting this command to any value, including an empty string, will clear the weblink log entries.

Supported Devices

- iMZ 220™, iMZ 320™
- QLn220™, QLn320™, QLn420™
- ZT210™, ZT220™, ZT230™

Type setvar, do

Commands	Details
setvar	This command clears the weblink alerts log entries. <i>Format:</i> ! U1 setvar "alerts.http.logging.clear" "value" <i>Values:</i> Any string value, including an empty string. <i>Default:</i> NA
do	This command clears the weblink alerts log entries. <i>Format:</i> ! U1 do "alerts.http.logging.clear" "value" <i>Values:</i> Any string value, including an empty string. <i>Default:</i> NA



Example • This example clears the log entries with an empty string value.

```
! U1 setvar "alerts.http.logging.clear" ""
```



Note •

- For printer support, see [SGD Command Support on page 1267](#).
- For details on SGD command structure, see [Command Structure on page 635](#).
- For details on HTTP POST, see [HTTP POST Alerts on page 1369](#).

alerts.http.logging.entries

Description This command returns the N number of entries in the http log, where N has a maximum value that is set by `alerts.http.logging.max_entries`.

The alerts http log is a collection of events related to sending HTTP POST messages. The log entries range anywhere from general status to errors that prevented a successful connection. Each log entry contains a timestamp for when it was logged by the system. The newest events will appear at the bottom of the list.

Supported Devices

- iMZ 220™, iMZ 320™
- QLn220™, QLn320™, QLn420™
- ZT210™, ZT220™, ZT230™

Type `getvar`

Commands	Details
<code>getvar</code>	This command returns the number of entries in the HTTP log. <i>Format:</i> ! U1 <code>getvar "alerts.http.logging.entries"</code> <i>Values:</i> NA <i>Default:</i> NA



Example • This example shows the result from `alerts.http.logging.entries`:

```
[01-03-2013 12:48:59.964] [http] Connected to 10.3.4.58 (10.3.4.58) port 80  
[01-03-2013 12:48:59.978] [http] HTTP/1.1 100 Continue  
[01-03-2013 12:49:01.999] [http] Closing connection
```



Note

- For printer support, see [SGD Command Support on page 1267](#).
- For details on SGD command structure, see [Command Structure on page 635](#).
- For details on HTTP POST, see [HTTP POST Alerts on page 1369](#).

alerts.http.logging.max_entries

Description This command specifies the maximum number of individual log entries that will be stored in the `alert.http.logging.entries` command.



Important • Changes to this command are immediate and may result in some log entries being lost. If there are N log entries currently in the log, the user sets the `max_entries` to M, where M is less than N, the oldest (N-M) log entries will be removed.

Supported Devices

- iMZ 220™, iMZ 320™
- QLn220™, QLn320™, QLn420™
- ZT210™, ZT220™, ZT230™

Type `setvar, getvar, do`

Commands	Details
<code>setvar</code>	This command sets the maximum number of log entries that will be stored. <i>Format:</i> <code>! U1 getvar "alerts.http.logging.max_entries" "value"</code> <i>Values:</i> 0 - 10000 Note • Setting the value to 0 disables logging. <i>Default:</i> "0"
<code>getvar</code>	This command returns the setting for the maximum number of log entries that will be stored. <i>Format:</i> <code>! U1 getvar "alerts.http.logging.max_entries"</code>
<code>do</code>	This command sets the maximum number of log entries that will be stored. <i>Format:</i> <code>! U1 do "alerts.http.logging.max_entries" "value"</code> <i>Values:</i> 0 - 10000 Note • Setting the value to 0 disables logging. <i>Default:</i> "0"



Example • In this example, `alerts.http.logging.max_entries` is then set to 2.

```
[01-03-2013 12:48:59.964] [http] Connected to 10.3.4.58 (10.3.4.58) port 80
[01-03-2013 12:48:59.978] [http] HTTP/1.1 100 Continue
[01-03-2013 12:49:01.999] [http] Closing connection
```

When it is set to 2

```
[01-03-2013 12:48:59.978] [http] HTTP/1.1 100 Continue
[01-03-2013 12:49:01.999] [http] Closing connection
```



Note

- For printer support, see [SGD Command Support on page 1267](#).
- For details on SGD command structure, see [Command Structure on page 635](#).
- For details on HTTP POST, see [HTTP POST Alerts on page 1369](#).

alerts.http.proxy

Description This command assigns the URL of the proxy for any HTTP POST alerts. The proxy server protocol, port, domain, username, and password are all encoded into the URL via the format outlined in RFC2396 (<http://www.ietf.org/rfc/rfc2396.txt>).

The username and password must avoid the invalid characters listed in RFC2396 (e.g. ':', '@', '/', etc). If an invalid character must be used it needs to be escaped using '%' as described in RFC2396.

When the setting is changed, the next HTTP POST alert will use the new value.

Supported Devices

- iMZ 220™, iMZ 320™
- QLn220™, QLn320™, QLn420™
- ZT210™, ZT220™, ZT230™

Type setvar, getvar, do

Commands	Details
setvar	<p>This command assigns the proxy URL for HTTP POST alerts.</p> <p><i>Format:</i> ! U1 setvar "alerts.http.proxy" "http://username:password@mydomain.com:3128/"</p> <p><i>Values:</i> Any valid URL up to 2048 characters URL format expected: <code>http://[user:pass@]domain[:port]/[path]</code></p> <p><i>Default:</i></p> <ul style="list-style-type: none"> • The user:pass, port, and path are all optional. • The default port is 1080. • The default is to omit the username and password.
getvar	<p>This command retrieves the proxy URL for HTTP POST alerts.</p> <p><i>Format:</i> ! U1 getvar "alerts.http.proxy"</p>
do	<p>This command assigns the proxy URL for HTTP POST alerts.</p> <p><i>Format:</i> ! U1 do "alerts.http.proxy" "http://username:password@mydomain.com:3128/"</p> <p><i>Values:</i> Any valid URL up to 2048 characters URL format expected: <code>http://[user:pass@]domain[:port]/[path]</code></p> <p><i>Default:</i></p> <ul style="list-style-type: none"> • The user:pass, port, and path are all optional. • The default port is 1080. • The default is to omit the username and password.



Example • Examples of how to connect to various proxy servers:

```
http://username:password@mydomain.com:3128/  

http://mydomain.com/
```



Note •

- For printer support, see [SGD Command Support](#) on page 1267.
- For details on SGD command structure, see [Command Structure](#) on page 635.
- For details on HTTP POST, see [HTTP POST Alerts](#) on page 1369.

alerts.tracked_settings.log_tracked

Description This command creates a comma-delimited list of settings for which sets should be logged.

Supported Devices

- iMZ 220™, iMZ 320™
- QLn220™, QLn320™, QLn420™
- ZT210™, ZT220™, ZT230™

Type setvar, getvar, do

Commands	Details
setvar	This command sets the list of settings for which sets should be logged. <i>Format:</i> ! U1 setvar "alerts.tracked_settings.log_tracked" "settings.name1,settings.name2..." <i>Values:</i> Settings with commas between names. <i>Default:</i> ""
getvar	This command returns a comma-delimited lists of settings being logged. <i>Format:</i> ! U1 getvar "alerts.tracked_settings.log_tracked"
do	This command sets the list of settings for which sets should be logged. <i>Format:</i> ! U1 do "alerts.tracked_settings.log_tracked" "settings.name1,settings.name2..." <i>Values:</i> Settings with commas between names. <i>Default:</i> ""



Note •

- For printer support, see [SGD Command Support on page 1267](#).
- For details on SGD command structure, see [Command Structure on page 635](#).

alerts.tracked_settings.clear_log

Description This command clears the `alerts.tracked_settings.log`. Setting this command to any value, including an empty string, will clear the `tracked_sgds` log entries.

Supported Devices

- iMZ 220™, iMZ 320™
- QLn220™, QLn320™, QLn420™
- ZT210™, ZT220™, ZT230™

Type `setvar`, `do`

Commands	Details
<code>setvar</code>	This command clears the <code>tracked_sgds</code> log entries. <i>Format:</i> <code>! U1 setvar "alerts.tracked_settings.clear_log" "value"</code> <i>Values:</i> Any string value, including an empty string. <i>Default:</i> NA
<code>do</code>	This command clears the <code>tracked_sgds</code> log entries. <i>Format:</i> <code>! U1 do "alerts.tracked_settings.clear_log" "value"</code> <i>Values:</i> Any string value, including an empty string. <i>Default:</i> NA



Example • This example clears the log entries with an empty string value.

```
! U1 setvar "alerts.tracked_settings.clear_log" ""
```



Note

- For printer support, see [SGD Command Support on page 1267](#).
- For details on SGD command structure, see [Command Structure on page 635](#).

alerts.tracked_sgds.log

Description This command reports the log of the settings listed in `alerts.tracked_settings.log_tracked`. The log entries will be fully JSON compliant.

Supported Devices

- iMZ 220™, iMZ 320™
- QLn220™, QLn320™, QLn420™
- ZT210™, ZT220™, ZT230™

Type `getvar`

Commands	Details
<code>getvar</code>	This command retrieves the current log. <i>Format: ! U1 getvar "alerts.tracked_sgds.log"</i>



Example • Sending `! U1 getvar "alerts.tracked_settings.log"` returns:

```
:"[{"settingsName":"newValue","timestamp":  
:"06-24-2012 19:51:28.641"}]" for 1 entry or  
"[{"settingsName":"newValue","timestamp":  
:"06-24-2012  
19:51:28.641"},\r\n{"settingsName2":"newValue2","timestamp":"06-24-2012  
19:51:30.641"}] for 2 entries.
```

Note • When the log is empty, the result will be:

```
""
```



Note •

- For printer support, see [SGD Command Support on page 1267](#).
- For details on SGD command structure, see [Command Structure on page 635](#).

alerts.tracked_sgds.max_log_entries

Description This command sets the maximum number of entries to be shown in `alerts.tracked_settings.log`.

Supported Devices

- iMZ 220™, iMZ 320™
- QLn220™, QLn320™, QLn420™
- ZT210™, ZT220™, ZT230™

Type `setvar, getvar, do`

Commands	Details
<code>setvar</code>	This command sets the maximum number of alert log entries that will be stored. <i>Format:</i> <code>! U1 setvar "alerts.tracked_sgds.max_log_entries" "value"</code> <i>Values:</i> 0 - 10000 Note • Setting the value to 0 disables logging. <i>Default:</i> "100"
<code>getvar</code>	This command returns the setting for the maximum number of alert log entries that will be stored. <i>Format:</i> <code>! U1 getvar "alerts.tracked_sgds.max_log_entries"</code>
<code>do</code>	This command sets the maximum number of alert log entries that will be stored. <i>Format:</i> <code>! U1 setvar "alerts.tracked_sgds.max_log_entries" "value"</code> <i>Values:</i> 0 - 10000 Note • Setting the value to 0 disables logging. <i>Default:</i> "100"



Example • This example sets the maximum log entries to 50.

```
! U1 setvar "alerts.tracked_sgds.max_log_entries" "50"
```



Note

- For printer support, see [SGD Command Support on page 1267](#).
- For details on SGD command structure, see [Command Structure on page 635](#).

alerts.tracked_sgds.zbi_notified

Description This command provides a comma-delimited list of settings for which ZBI should be notified when the value is set.

Supported Devices

- iMZ 220™, iMZ 320™
- QLn220™, QLn320™, QLn420™
- ZT210™, ZT220™, ZT230™

Type setvar, getvar, do

Commands	Details
setvar	<p>This command sets the list of the settings for which ZBI will be notified when the setting is set.</p> <p><i>Format:</i> ! U1 setvar "alerts.tracked_settings.zbi_notified" "settings.name1, settings.name2, etc."</p> <p><i>Values:</i> A comma delimited list of settings names</p> <p><i>Default:</i> ""</p>
getvar	<p>This command retrieves the list of the settings for which ZBI will be notified when the value is set.</p> <p><i>Format:</i> U1 getvar "alerts.tracked_settings.zbi_notified"</p>
do	<p>This command sets the list of the settings for which ZBI will be notified when the value is set.</p> <p><i>Format:</i> ! U1 do "alerts.tracked_settings.zbi_notified" "settings.name1, settings.name2, etc."</p> <p><i>Values:</i> A comma delimited list of settings names</p> <p><i>Default:</i> ""</p>



Note •

- For printer support, see [SGD Command Support](#) on page 1267.
- For details on SGD command structure, see [Command Structure](#) on page 635.

apl.version

Description This command returns the revision number of the Virtual Device system.

Type `getvar`

Supported Devices Link-OS printers with firmware Vxx.19.7Z and later.

Commands	Details
<code>getvar</code>	Displays the revision number of the Virtual Device system. <i>Format: ! U1 getvar "apl.version"</i>



Note •

- For printer support, see [SGD Command Support on page 1267](#).
- For details on SGD command structure, see [Command Structure on page 635](#).

appl.link_os_version

Description This command lists the version of the Link-OS™ feature set that is supported by the printer.

Supported Devices

- iMZ 220™, iMZ 320™
- QLn220™, QLn320™, QLn420™
- ZT210™, ZT220™, ZT230™

Type `getvar`

Commands	Details
<code>getvar</code>	This command retrieves the Link-OS™ version of the printer. <i>Format: ! U1 getvar "appl.link_os_version"</i>

➔ **Example** • In this example, the `getvar` command returns version 1.0 of Link-OS™.

```
! U1 getvar "appl.link_os_version"
```

returns

```
1.0
```



Note •

- For printer support, see [SGD Command Support on page 1267](#).
- For details on SGD command structure, see [Command Structure on page 635](#).

appl.option_board_version

Description This command returns the version number of the firmware running on the wireless option board. For printer support, see *SGD Command Support on page 1267*.

Type `getvar`

Commands	Details
<code>getvar</code>	This command returns the version number of the firmware running on the wireless option board. <i>Format:</i> <code>! U1 getvar "appl.option_board_version"</code>



Note • For details on SGD command structure, see *Command Structure on page 635*.



Example • This command returns the version number of the firmware running on the wireless option board.

```
! U1 getvar "appl.option_board_version"
"0.0.0 *"
```

appl.bootblock

Description This command refers to the bootblock version. On the configuration label, the bootblock number is identified as the hardware ID. For printer support, see [SGD Command Support on page 1267](#).

Type `getvar`

Commands	Details
<code>getvar</code>	This command returns the bootblock version number that appears on the configuration label. <i>Format:</i> <code>! U1 getvar "appl.bootblock"</code>



Note • For details on SGD command structure, see [Command Structure on page 635](#).



Example • In this example, the `getvar` returns the bootblock version number.
`! U1 getvar "appl.bootblock"`

appl.date

Description This command refers to the date the firmware was created. For printer support, see [SGD Command Support on page 1267](#).

Type getvar

Commands	Details
getvar	The printer will respond with the date the firmware was created in the mm/dd/yy format. <i>Format: ! U1 getvar "appl.date"</i> <i>Format: This is standard text.</i> <i>Format:</i>



Note • For details on SGD command structure, see [Command Structure on page 635](#).



Example • In this example, the `getvar` returns the date the firmware was created.

```
! U1 getvar "appl.date"
```

Result: "01/29/10"

appl.name

Description This command refers to the printer's firmware version. For printer support, see [SGD Command Support on page 1267](#).

Type `getvar`

Commands	Details
<code>getvar</code>	This command returns the printer's firmware version. <i>Format: ! U1 getvar "appl.name"</i>



Note • For details on SGD command structure, see [Command Structure on page 635](#).



Example • In this example, the `getvar` returns the printer's firmware version.

```
! U1 getvar "appl.name"
```

capture.channel1.count

Description This command indicates the number of times that `capture.channel1.delimiter` was seen on the port specified in `capture.channel1.port`. Additionally, it indicates how many times `capture.channel1.data.raw` has been updated with user data as well as the number of times we reached the `capture.channel1.max_length`.

This will be shown in the [HZA](#) response under the capture data section.

Supported Devices

- iMZ 220™, iMZ 320™
- QLn220™, QLn320™, QLn420™
- ZT210™, ZT220™, ZT230™

Type `getvar`

Commands	Details
<code>getvar</code>	<p>This command returns the number of times that <code>capture.channel1.delimiter</code> was seen on the port specified in <code>capture.channel1.port</code> as well as the number of times we reached the <code>capture.channel1.max_length</code>.</p> <p><i>Format: ! U1 getvar "capture.count"</i></p>



Note •

- For printer support, see [SGD Command Support on page 1267](#).
- For details on SGD command structure, see [Command Structure on page 635](#).

capture.channel1.data.mime

Description This command provides a view to the data captured on the port specified by `capture.channel1.port` in a mime/base64 encoded format.

Supported Devices

- iMZ 220™, iMZ 320™
- QLn220™, QLn320™, QLn420™
- ZT210™, ZT220™, ZT230™

Type `getvar`

Commands	Details
<code>getvar</code>	<p>This command retrieves the data captured on the port specified by <code>capture.channel1.port</code>.</p> <p><i>Format:</i> ! U1 <code>getvar "capture.channel1.data.mime"</code></p> <p><i>Result:</i> Data in mime-encoded format.</p>



Note •

- For printer support, see [SGD Command Support on page 1267](#).
- For details on SGD command structure, see [Command Structure on page 635](#).

capture.channel1.data.raw

Description This command retrieves the user data captured off of the port specified in `capture.channel1.port`.

Any binary zeros in the capture.data stream will be replaced with the escaped representation of NULL ("`\000`"). The delimiter data is not stored as part of the captured data.

This will be shown in the [HZA](#) output within capture data section.

Supported Devices

- iMZ 220™, iMZ 320™
- QLn220™, QLn320™, QLn420™
- ZT210™, ZT220™, ZT230™

Type `getvar`

Commands	Details
<code>getvar</code>	This command retrieves the user data captured off of the port specified in <code>capture.channel1.port</code> . <i>Format:</i> ! U1 <code>getvar "capture.channel1.data.raw"</code>



Note •

- For printer support, see [SGD Command Support on page 1267](#).
- For details on SGD command structure, see [Command Structure on page 635](#).

capture.channel1.delimiter

Description This command stores the delimiter used to partition data received on the port specified by `capture.channel1.port` and stored in `capture.channel1.data.raw` and `capture.channel1.data.mime`.

This will be reported in the data capture section of the HZA response.

Supported Devices

- iMZ 220™, iMZ 320™
- QLn220™, QLn320™, QLn420™
- ZT210™, ZT220™, ZT230™

Type `setvar, getvar`

Commands	Details
<code>setvar</code>	<p>This command sets the delimiter used to partition data received on the <code>capture.channel1.port</code>.</p> <p><i>Format:</i> <code>! U1 setvar "capture.channel1.delimiter" "delimiter"</code></p> <p><i>Values:</i> Any character set up to a maximum of 64 characters in length.</p> <p> Note • Binary data can be used in the delimiter. To do this enter a '\ ' and then the 3 digit octal value of the character. "\\ " = '\ ' in some tools, so to get \002 you may need to enter "\\002". Escaped octal characters count as a single character and not 4 (e.g. a delimiter of "\\001\000\002" is 3 characters, not 12)</p> <p><i>Default:</i> <code>"\012"</code></p>
<code>getvar</code>	<p>This command retrieves the delimiter.</p> <p><i>Format:</i> <code>! U1 getvar "capture.channel1.delimiter"</code></p>



Example • Binary data can be used in the delimiter. To do this enter a '\ ' and then the 3 digit octal value of the character. Note: "\\ " = '\ ' in some tools, so to get \002 you may need to enter "\\002".

`"\000" = NULL (single character)`

`"end\015\012\000" = 'e'+ 'n'+ 'd'+ '\r'+ '\n'+ NULL (total of 6 characters)`



Note

- For printer support, see [SGD Command Support on page 1267](#).
- For details on SGD command structure, see [Command Structure on page 635](#).

capture.channel1.max_length

Description This command sets a length indicating when to copy captured data to the data SGD if the delimiter has not been seen yet.

If the delimiter and the max_length are reached at the same time, the delimiter will not be part of the captured data. Of only part of the delimiter has been received, then the part of the delimiter we have received, will be part of the capture data.

When the max_length is changed, any data currently in the buffer will be thrown away, and the new value of max_length will be used.

The Capture Port shall be defaulted to 1000 bytes by any mechanism (including ^JUF, ^JUN, ^JUA, and device.restore_defaults).

Supported Devices

- iMZ 220™, iMZ 320™
- QLn220™, QLn320™, QLn420™
- ZT210™, ZT220™, ZT230™

Type setever, getvar

Commands	Details
setvar	This command instructs the printer to set a default data capture length. <i>Format:</i> ! U1 setvar "capture.channel1.max_length" "value" <i>Values:</i> 1-3000 <i>Default:</i> "1000"
getvar	This command retrieves the default data capture length. <i>Format:</i> ! U1 getvar "capture.channel1.max_length"



Note •

- For printer support, see [SGD Command Support on page 1267](#).
- For details on SGD command structure, see [Command Structure on page 635](#).

capture.channel1.port

Description This command determines the port that should be monitored for user data. This allows the user to attach an external device, such as a keyboard or barcode scanner, and have input captured into the `capture.channel1.data.raw` command. Once the data is in the SGD they can use it as they would any other SGD (this includes functionality that allows users to be sent an alert when an SGD value changes).

The data received on the specified port will be read until the value in `capture.channel1.delimiter` is seen, at which point the data received until (but not including) the delimiter will be stored in `capture.channel1.data.raw`.

For the port specified in `capture.channel1.port`, no data will be sent to any of the parsers on that port. All data received is assumed to be user input that is to be placed in `capture.channel1.data.raw`. To disable the data capture functionality, set `capture.channel1.port` to "off"

- The delimiter will not be stored in `capture.channel1.data.raw`.
- The port will be shown in the data capture portion of the HZA response.
- The capture port shall be defaulted to "off" by any mechanism (including ^JUF, ^JUA, and `device.restore_defaults`).

Supported Devices

- iMZ 220™, iMZ 320™
- QLn220™, QLn320™, QLn420™
- ZT210™, ZT220™, ZT230™

Type setvar, getvar

Commands	Details
setvar	<p>This command sets the port to be monitored for user data.</p> <p><i>Format:</i> ! U1 setvar "capture.channel1.port" "value"</p> <p><i>Values:</i> off,serial,usb,bt,usb_host</p> <ul style="list-style-type: none"> • off - no data is stored in <code>capture.channel1.data.raw</code> and all data is sent to the parsers - normal operation • serial - Data is read off the serial port. No data sent to the parsers on this port. • usb - Data is read off the usb port. No data sent to the parsers on this port. • bt - Data is read off the Bluetooth® port. No data sent to the parsers on this port. • usb_host - not yet supported. reserved for when usb host is implemented. <p><i>Default:</i> "off"</p>
getvar	<p>This command retrieves the printer's current port being monitored for user data.</p> <p><i>Format:</i> ! U1 getvar "capture.channel1.port"</p>

➔ **Example** • This example sets the command value to "off", preventing it from capturing data.

```
! U1 setvar "capture.channel1.port" "off"
```



Note •

- For printer support, see [SGD Command Support on page 1267](#).
- For details on SGD command structure, see [Command Structure on page 635](#).

CISDFCRC16

Download Files

The `CISDFCRC16` command downloads supported files types to the printer.



Note • When using certificate files, your printer supports:

- Using Privacy Enhanced Mail (PEM) formatted certificate files.
- Using the client certificate and private key as two files, each downloaded separately.
- Using exportable PAC files for EAP-FAST.



Important • When using certificate files, the time on the printer must be set correctly for the websocket connection to succeed, as the time is used in the certificate validation.

Important • Each line should be terminated with a CR/LF.

Type

```
! CISDFCRC16
<crc>
<filename>
<size>
<checksum>
<data>
```

Parameters	Details
<code><crc></code> = CRC value	<i>Accepted Values:</i> a four digit CRC value in hexadecimal. If <code>0000</code> is entered, then the CRC validation is ignored. For examples, see below.
<code><filename></code> = file name	<i>Accepted Values:</i> file name that is stored on the printer's file system. An extension must be specified. Files must be saved to the E: drive.
<code><size></code> = file size	<i>Accepted Values:</i> an eight digit file size specified in hexadecimal which indicates the number of bytes in the <code><data></code> section.
<code><checksum></code> = checksum value	<i>Accepted Values:</i> a four digit checksum value in hexadecimal. If <code>0000</code> is entered, then the CRC validation is ignored. The checksum value is calculated using the sum of the bytes in the <code><data></code> section. For examples, see below.
<code><data></code> = data	<i>Accepted Values:</i> Binary data saved on the printer's file system as <code><filename></code> . Number of bytes in this field must match the <code><size></code> parameter.



Note • This command can be used in place of the `~DG` and `~DY` command for more saving and loading options. `~DY` is the preferred command to download TrueType fonts on printers with firmware later than X.13. The `CISDFCRC16` command also supports downloading wireless certificate files.

➔ **Example 1** • This example shows the `CISDFCRC16` command used to download a private key file (`privkey.nrd`) to the printer. The different sections of the command are on separate lines.

```
! CISDFCRC16
BA0B
privkey.nrd
0000037B
E3AF
-----BEGIN RSA PRIVATE KEY-----
MIICXgIBAAKBgQDQXu/E9YuG1ScfWQepZa8Qe/1mJRpmk8oPhPVvam/4M5/WaWQp
3/p1f8J17/hDH8fFq5Dnx3/tHaU7A4SK08GeghX5hnp/mt4tuQEvsXkCrcgS1puz
z5db07ThhuzxYClnr7uiXPvSRXawgwDTPas+0q/6gHeUSXtA0EofuIyv7wIDAQAB
AoGBAJPnf3wn6wT5pE59DJIyakRiLmkt1wK0zvObJfgS7i2Yv1EbeAy9PnPe3vKG
Bovm6A+oi2/qTSTLUTiFc7QHxJPVxLmRiHMbf1Q8j+VJkGTpwt8EY/Px+HSM2HAP
jqd+Im0IiE9RQPsxWQH9UaauF6n15gIFMF74BIPsVzFXLffxAkEA6zSrCKCycE/P
14cjZibnLiWxdL3U3I9eWuhmIS37RB6UJFBCWUPWr26H1HzOKqhOUMbF5h0mvkZ
gciN9A8kxwJBAOLK7Gyorre8iK9IMMwC70IJC7H8pH1y/N20tyaC1XuPfqz0H4PH
w2W2m3BhZ7ggHJLLiiFVF+Hr5X7cibFD05kCQQDFe51HSzXHWxvViN/N+0gL1RYk
Q0cistW1+n8VyLe5wDr+Km0q6eytq44mvIuWAW6QH/TfZxBIynICKFQX4UctAkAm
P80iAkz9RfnTfhxjp7S35poxoYdodPU6tLAK+ZnhrfDSYJXUFuPYirSqfnMMtbW7
+EICnyRZAP0CqVU7pUm5AkEAnH206dKvUvw0EX+CscVATRrejKLCeJ+6YZWqid9X
0XGJgrHNXGpDtQiVSGM59p0XnHTZJYjvVNdNOMnhg333nQ==
-----END RSA PRIVATE KEY-----
```

➔ **Example 2** • These are examples of CRC and checksum values:

CRC example

The value of the `<crc>` field is calculated the CRC-16 for the contents of a specified file using the CRC16-CCITT polynomial which is $x^{16} + x^{12} + x^5 + 1$. It is calculated using an initial CRC of 0x0000.

checksum example

Given 4 bytes of data : 0x25, 0x62, 0x3F, 0x52:

1. Adding all bytes together gives 0x118.
2. Drop the carry nibble to get 0x18.
3. Get the two's complement of the 0x18 to get 0xE8.

This is the checksum byte.



Note •

- For printer support, see [SGD Command Support on page 1267](#).
- For details on SGD command structure, see [Command Structure on page 635](#).

comm.baud

Description This command refers to the printer’s comm (cable) baud rate. For printer support, see [SGD Command Support on page 1267](#).



Important • Once the printer’s communication port parameters have been changed, the host terminal must also be configured to match the new printer settings before the host can communicate again.

Type setvar;getvar

Commands	Details
setvar	<p>This command instructs the printer to change the baud rate.</p> <p><i>Format:</i> ! U1 setvar "comm.baud" "value"</p> <p><i>Values:</i></p> <ul style="list-style-type: none"> “9600” “19200” “38400” “57600” “115200” <p><i>Default:</i> "19200"</p>
getvar	<p>This command instructs the printer to respond with the curenly set printer baud rate.</p> <p><i>Format:</i> ! U1 getvar "comm.baud"</p>



Note • For details on SGD command structure, see [Command Structure on page 635](#).



Example 1 • In this example, the `getvar` retrieves the current baud rate.

```
! U1 getvar "comm.baud"
```



Example 2 • This `setvar` example sets the communications baud rate to 19200 BPS.

```
! U1 setvar "comm.baud" "19200"
```

comm.halt

Description This command halts all communications to the serial port if an error condition occurs.

Supported Devices ZT200 Series

Type setvar;setvar

Commands	Details
setvar	<p>This command instructs the printer to halt communication to the printer.</p> <p><i>Format:</i> ! U1 setvar "comm.halt" "value"</p> <p><i>Values:</i></p> <p>"yes"</p> <p>"no"</p> <p><i>Default:</i> "yes"</p>
getvar	<p>This command returns the current value.</p> <p><i>Format:</i> ! U1 getvar "comm.halt"</p> <p><i>Values:</i></p> <p>"yes"</p> <p>"no"</p>



Example • This `setvar` example sets the value set to "yes".

```
! U1 setvar "comm.halt" "yes"
```



Note •

- For printer support, see [SGD Command Support on page 1267](#).
- For details on SGD command structure, see [Command Structure on page 635](#).

comm.pnp_option

Description The `comm.pnp_option` command configures the RS-232 Serial Port Plug and Play setting on the printer. For printer support, see *SGD Command Support* on page 1267.

Type setvar;getvar

Commands	Details
setvar	<p>This command instructs the printer to change the <code>comm.pnp_option</code> setting.</p> <p><i>Format:</i> ! U1 setvar "comm.pnp_option" "value"</p> <p><i>Values:</i></p> <ul style="list-style-type: none"> "off" = sets the printer to not attempt Plug and Play via serial at startup "on" = sets the printer to attempt Plug and Play via serial at startup <p><i>Default:</i> "off"</p>
getvar	<p>This command causes the printer to return the current setting for the <code>comm.pnp_option</code> setting.</p> <p><i>Format:</i> ! U1 getvar "comm.pnp_option"</p>



Note • For details on SGD command structure, see *Command Structure* on page 635.



Example • In this example, the `setvar` sets the serial port communications state to "on".

```
! U1 setvar "comm.pnp_option" "on"
```

When the setvar value is set to "on", the `getvar` result is "on".



Note • Not all Operating Systems and computer hardware support Plug and Play over RS-232 Serial port connections.

comm.type

Description This printer setting determines the behavior of the serial port interface. It selects one of three serial communication states: DTE, DCE or Autodetect. For printer support, see [SGD Command Support on page 1267](#).

Supported Devices

- LP 2824 Plus

Type setvar;getvar

Commands	Details
setvar	<p>This command instructs the printer to change the serial port interface type.</p> <p><i>Format:</i> ! U1 setvar "comm.type" "value"</p> <p><i>Values:</i></p> <ul style="list-style-type: none"> "auto" = Autodetect "dte" = Force DTE (Tx on pin 2) "dce" = Force DCE (Rx on pin 2) <p><i>Default:</i> "auto"</p>
getvar	<p>This command instructs the printer to respond with the current serial port interface type.</p> <p><i>Format:</i> ! U1 getvar "comm.type"</p>



Note • For details on SGD command structure, see [Command Structure on page 635](#).



Example 1 • In this example, the `getvar` retrieves the serial port communications state.

```
! U1 getvar "comm.type"
```



Example 2 • This `setvar` example sets the communications port state to Autodetect.

```
! U1 setvar "comm.type" "auto"
```

comm.parity

Description This command sets the printer’s communication parity. For printer support, see [SGD Command Support on page 1267](#).



Important • Once the printer’s communication port parameters have been changed, the host terminal must also be configured to match the new printer settings before the host can communicate again.

Type setvar;getvar

Commands	Details
setvar	<p>This command instructs the printer to set the communication port parity .</p> <p><i>Format:</i> ! U1 setvar "comm.parity" "value"</p> <p><i>Values:</i></p> <ul style="list-style-type: none"> "N" — None "E" – Even "O" – Odd <p><i>Default:</i> "N"</p>
getvar	<p>This command instructs the printer to respond with the currently set printer parity.</p> <p><i>Format:</i> ! U1 getvar "comm.parity"</p>



Note • For details on SGD command structure, see [Command Structure on page 635](#).



Example 1 • In this example, the `getvar` retrieves the currently set printer parity.

```
! U1 getvar "comm.parity"
```



Example 2 • This `setvar` example sets the parity to None.

```
! U1 setvar "comm.parity" "N"
```

comm.stop_bits

Description This command refers to the printers’s communication port stop bits. For printer support, see *SGD Command Support on page 1267*.



Important • Once the printer’s communication port parameters have been changed, the host terminal must also be configured to match the new printer settings before the host can communicate again.

Type setvar;getvar

Commands	Details
setvar	This command instructs the printer to configure the comm.port stop bit value. <i>Format:</i> ! U1 setvar "comm.stop_bits" "value" <i>Values:</i> "1" "2" <i>Default:</i> "1"
getvar	This command instructs the printer to respond with the currently set stop bit value. <i>Format:</i> ! U1 getvar "comm.stop_bits"



Note • For details on SGD command structure, see *Command Structure on page 635*.



Example 1 • In this example, the `getvar` retrieves the currently set stop bit value.

```
! U1 getvar "comm.stop_bits"
```



Example 2 • This `setvar` example configures the comm.port for 1 stop bit.

```
! U1 setvar "comm.stop_bits" "1"
```

cutter.clean_cutter

Description This command determines if the clean cutter option is enabled or disabled. For printer support, see *SGD Command Support* on page 1267.

Type setvar;getvar

Commands	Details
setvar	This command instructs the printer to set the clean cutter option. <i>Format:</i> ! U1 setvar "cutter.clean_cutter" <i>Values:</i> "on" = turns on clean cutter "off" = turns off clean cutter <i>Default:</i> "on"
getvar	This command retrieves the status of the clean cutter option. <i>Format:</i> ! U1 getvar "cutter.clean_cutter"



Note • For details on SGD command structure, see *Command Structure* on page 635.



Example • This `setvar` example shows the value set to "on".

```
! U1 setvar "cutter.clean_cutter" "on"
```

When the setvar value is set to "on", the `getvar` result is "on".

device.applicator.data_ready

Description This command will specify if a "high" or "low" value is required for the applicator to indicate it is ready to receive data.

Supported Devices

- ZE500™ series
- PAX4™ series
- Xi4™ series
- XiIIIPlus™ series

Type setvar, getvar

Commands	Details
setvar	This command sets the value. <i>Format:</i> ! U1 setvar "device.applicator.data_ready" "value" <i>Values:</i> high, low <i>Default:</i> low
getvar	This command instructs the printer to respond with the currently set value. <i>Format:</i> ! U1 getvar "device.applicator.data_ready"



Note •

- For printer support, see [SGD Command Support on page 1267](#).
- For details on SGD command structure, see [Command Structure on page 635](#).

device.applicator.end_print

Description This command allows you to control an online verifier or applicator device. This command is similar to the **b** parameter for [^JJ on page 264](#).

Supported Devices

- ZE500™ series
- PAX4™ series
- Xi4™ series
- XiIIIPlus™ series

Type setvar, getvar

Commands	Details
setvar	<p>This command sets the value for the applicator port mode</p> <p><i>Format:</i> ! U1 setvar "device.applicator.end_print" "value"</p> <p><i>Values:</i></p> <ul style="list-style-type: none"> off 1 =End Print signal normally high, and low only when the printer is moving the label forward. 2 = End Print signal normally low, and high only when the printer is moving the label forward. 3 = End Print signal normally high, and low for 20 ms when a label has been printed and positioned. 4 = End Print signal normally low, and high for 20 ms when a label has been printed and positioned. <p><i>Default:</i> off</p>
getvar	<p>This command instructs the printer to respond with the currently set value.</p> <p><i>Format:</i> ! U1 getvar "device.applicator.end_print"</p>



Note •

- For printer support, see [SGD Command Support on page 1267](#).
- For details on SGD command structure, see [Command Structure on page 635](#).

device.applicator.feed

Description This command will specify if a "high" or "low" value is required for an applicator to feed media.

Supported Devices

- ZE500™ series
- PAX4™ series
- Xi4™ series
- XiIIIPlus™ series

Type setvar, getvar

Commands	Details
setvar	This command sets the value. <i>Format:</i> ! U1 setvar "device.applicator.feed" "value" <i>Values:</i> high, low <i>Default:</i> low
getvar	This command instructs the printer to respond with the currently set value. <i>Format:</i> ! U1 getvar "device.applicator.feed"



Note •

- For printer support, see [SGD Command Support on page 1267](#).
- For details on SGD command structure, see [Command Structure on page 635](#).

device.appliator.media_out

Description This command will specify if a "high" or "low" value is required for an applicator to indicate that the media has run out.

Supported Devices

- ZE500™ series
- PAX4™ series
- Xi4™ series
- XiIIIPlus™ series

Type setvar, getvar

Commands	Details
setvar	This command sets the value. <i>Format:</i> ! U1 setvar "device.appliator.media_out" "value" <i>Values:</i> high, low <i>Default:</i> low
getvar	This command instructs the printer to respond with the currently set value. <i>Format:</i> ! U1 getvar "device.appliator.media_out"



Note •

- For printer support, see [SGD Command Support on page 1267](#).
- For details on SGD command structure, see [Command Structure on page 635](#).

device.applicator.pause

Description This command will specify if a "high" or "low" value is required for an applicator to pause printing.

Supported Devices

- ZE500™ series
- PAX4™ series
- Xi4™ series
- XiIIIPlus™ series

Type setvar, getvar

Commands	Details
setvar	This command sets the value. <i>Format:</i> ! U1 setvar "device.applicator.pause" "value" <i>Values:</i> high, low <i>Default:</i> low
getvar	This command instructs the printer to respond with the currently set value. <i>Format:</i> ! U1 getvar "device.applicator.pause"



Note •

- For printer support, see [SGD Command Support on page 1267](#).
- For details on SGD command structure, see [Command Structure on page 635](#).

device.applicator.reprint

Description This command will specify if a "high" or "low" value is required for an applicator to reprint a label. This command is similar to [~PR on page 330](#).

Supported Devices

- ZE500™ series
- PAX4™ series
- Xi4™ series
- XiIIIPlus™ series

Type setvar, getvar

Commands	Details
setvar	This command sets the value. <i>Format:</i> ! U1 setvar "device.applicator.reprint" "value" <i>Values:</i> high, low <i>Default:</i> low
getvar	This command instructs the printer to respond with the currently set value. <i>Format:</i> ! U1 getvar "device.applicator.reprint"



Note •

- For printer support, see [SGD Command Support on page 1267](#).
- For details on SGD command structure, see [Command Structure on page 635](#).

device.applicator.rfid_void

Description This command will specify if a "high" or "low" value is used for the RFID void signal, which occurs when an RFID label is voided by the printer.

Supported Devices

- ZE500™ series
- PAX4™ series
- Xi4™ series
- XiIIIPlus™ series

Type setvar, getvar

Commands	Details
setvar	This command sets the value. <i>Format:</i> ! U1 setvar "device.applicator.rfid_void" "value" <i>Values:</i> high, low <i>Default:</i> low
getvar	This command instructs the printer to respond with the currently set value. <i>Format:</i> ! U1 getvar "device.applicator.rfid_void"



Note •

- For printer support, see [SGD Command Support on page 1267](#).
- For details on SGD command structure, see [Command Structure on page 635](#).

device.applicator.ribbon_low

Description This command will specify if a "high" or "low" value is required for an applicator to indicate that the ribbon is running out.

Supported Devices

- ZE500™ series
- PAX4™ series
- Xi4™ series
- XiIIIPlus™ series

Type setvar, getvar

Commands	Details
setvar	This command sets the value. <i>Format:</i> ! U1 setvar "device.applicator.ribbon_low" "value" <i>Values:</i> high, low <i>Default:</i> high
getvar	This command instructs the printer to respond with the currently set value. <i>Format:</i> ! U1 getvar "device.applicator.ribbon_low"



Note •

- For printer support, see [SGD Command Support on page 1267](#).
- For details on SGD command structure, see [Command Structure on page 635](#).

device.applicator.ribbon_out

Description This command will specify if a "high" or "low" value is required for an applicator to indicate that the ribbon has run out.

Supported Devices

- ZE500™ series
- PAX4™ series
- Xi4™ series
- XiIIIPlus™ series

Type setvar, getvar

Commands	Details
setvar	This command sets the value. <i>Format:</i> ! U1 setvar "device.applicator.ribbon_out" <i>Values:</i> high, low <i>Default:</i> low
getvar	This command instructs the printer to respond with the currently set value. <i>Format:</i> ! U1 getvar "device.applicator.ribbon_out"



Note •

- For printer support, see [SGD Command Support on page 1267](#).
- For details on SGD command structure, see [Command Structure on page 635](#).

device.applicator.service_required

Description This command will specify if a "high" or "low" value is required for an applicator to indicate that maintenance is required.

Supported Devices

- ZE500™ series
- PAX4™ series
- Xi4™ series
- XiIIIPlus™ series

Type setvar, getvar

Commands	Details
setvar	This command sets the value. <i>Format:</i> ! U1 setvar "device.applicator.service_required" "value" <i>Values:</i> high, low <i>Default:</i> low
getvar	This command instructs the printer to respond with the currently set value. <i>Format:</i> ! U1 getvar "device.applicator.service_required"



Note •

- For printer support, see [SGD Command Support on page 1267](#).
- For details on SGD command structure, see [Command Structure on page 635](#).

device.applicator.start_print

Description This command will specify if a "high" or "low" value is required for an applicator to start printing.

Supported Devices

- ZE500™ series
- PAX4™ series
- Xi4™ series
- XiIIIPlus™ series

Type setvar, getvar

Commands	Details
setvar	This command sets the value. <i>Format:</i> ! U1 setvar "device.applicator.start_print" "value" <i>Values:</i> high, low <i>Default:</i> low
getvar	This command instructs the printer to respond with the currently set value. <i>Format:</i> ! U1 getvar "device.applicator.start_print"



Note •

- For printer support, see [SGD Command Support on page 1267](#).
- For details on SGD command structure, see [Command Structure on page 635](#).

device.command_override.active

Description This command enables or disables the device.command_override function. When enabled, the printer will ignore the list of commands previously specified using the device.command_override.add. Use of this command does not modify the list.

Type setvar;setvar

Commands	Details
setvar	This command sets the the printer to turn on/off device.command_override. <i>Format:</i> ! U1 setvar "device.command_override.active" "value" <i>Values:</i> yes = active no = inactive <i>Default:</i> yes
getvar	This command returns the active/inactive state of device.command_override. <i>Format:</i> ! U1 getvar "device.command_override.active" <i>Values:</i> yes = active no = inactive <i>Default:</i> yes



Examples •

```
! U1 setvar "device.command_override.active" "yes"  
! U1 setvar "device.command_override.active" "no"
```



Note •

- For printer support, see [SGD Command Support on page 1267](#).
- For details on SGD command structure, see [Command Structure on page 635](#).

device.command_override.add

Description This command adds a specified command to the list of commands that will be ignored by the printer. The list is saved when the printer is powered off. The list is not cleared when the printer is defaulted.

- If there are items in the list and the `device.command_override.active` is set to "yes", then the config label will show `ACTIVE COMMAND OVERRIDE`.
- If there are no items in the list or `device.command_override.active` is set to "no", then the config label will show `INACTIVE COMMAND OVERRIDE`.

Type setvar

Commands	Details
setvar	<p>The <code>add</code> command instructs the printer to add a specified command to the list of override commands..</p> <p><i>Format:</i> ! U1 setvar "device.command_override.add" "command"</p> <p><i>Values:</i> any ZPL or Set/Get/Do command</p> <p><i>Default:</i> NA</p>



Example • When specifying a ZPL command, the command must be preceded by the current format or control prefix character (e.g. ^ or ~). Multiple commands must be declared with its own setvar declaration.

```
! U1 setvar "device.command_override.add" "^MN"
! U1 setvar "device.command_override.add" "^PR"
! U1 setvar "device.command_override.add" "comm.baud"
! U1 setvar "device.command_override.add" "device.reset"
```



Example • The following example would **NOT** be valid.

```
! U1 setvar "device.command_override.add" "~HI,~HS,^MN"
and would have to be re-sent as
```

```
! U1 setvar "device.command_override.add" "~HI"
! U1 setvar "device.command_override.add" "~HS"
! U1 setvar "device.command_override.add" "^MN"
```



Important • You can not add `"device.command_override.clear"` to the list of accepted override commands.



Note •

- For printer support, see [SGD Command Support on page 1267](#).
- For details on SGD command structure, see [Command Structure on page 635](#).

device.command_override.clear

Description This command clears all commands from the command override list.

Type setvar

Commands	Details
setvar	<p>The <code>clear</code> command clears the list of override commands specified in device.command_override.list on page 695.</p> <p><i>Format:</i> ! U1 setvar "device.command_override.clear" "value"</p> <p><i>Values:</i> NA</p> <p><i>Default:</i> NA</p>



Note •

- For printer support, see [SGD Command Support](#) on page 1267.
- For details on SGD command structure, see [Command Structure](#) on page 635.

device.command_override.list

Description This command returns to the host a list of the current set of commands that the printer will ignore.

Type setvar

Commands	Details
getvar	<p>The <code>list</code> command prints a comma-delimited list of override commands.</p> <p><i>Format:</i> ! U1 getvar "device.command_override.list"</p> <p><i>Values:</i> NA</p> <p><i>Default:</i> NA</p>



Note •

- For printer support, see [SGD Command Support on page 1267](#).
- For details on SGD command structure, see [Command Structure on page 635](#).

device.company_contact

Description This command sets the company contact information, which can be accessed from the server/sysinfo.htm webpage.

Type setvar;getvar

Supported Devices Link-OS printers with firmware Vxx.19.7Z and later.

Commands	Details
setvar	Sets the company contact information. <i>Format:</i> ! U1 setvar "device.company_contact" "value" <i>Values:</i> Any string up to 128 characters in length <i>Default:</i> ""
getvar	Displays the current company contact information. <i>Format:</i> ! U1 getvar "device.company_contact"



Example • This setvar example shows the value set to "Zebra".

```
! U1 setvar "device.company_contact" "Zebra"
```



Note •

- For printer support, see [SGD Command Support on page 1267](#).
- For details on SGD command structure, see [Command Structure on page 635](#).

device.cpcl_synchronous_mode

Description This command enables/disables CPCL synchronous mode. When the printer is in sync mode, parsing will "lock" while printing is going on, allowing behavior similar to that of the legacy SH3 mobile printers.

Supported Devices QLn™ series

Type setvar;setvar

Commands	Details
setvar	This command sets the the printer to turn on/off <code>device.cpcl_synchronous_mode</code> . <i>Format:</i> ! U1 setvar "evice.cpcl_synchronous_mode" "value" <i>Values:</i> on = puts the printer in CPCL synchronous mode off = puts the printer in default mode <i>Default:</i> off
getvar	This command returns the the current value of the setting. <i>Format:</i> ! U1 getvar "evice.cpcl_synchronous_mode"



Description Consider issuing a label immediately followed by an SGD request. When sync mode is "off", the SGD will be returned nearly immediately after submitting the label. When sync mode is "on", the SGD will be returned after the label has printed.

Examples •

```
! U1 setvar "evice.cpcl_synchronous_mode" "on"
! U1 setvar "evice.cpcl_synchronous_mode" "off"
```



Note •

- For printer support, see [SGD Command Support on page 1267](#).
- For details on SGD command structure, see [Command Structure on page 635](#).

device.cutter_installed

Description This command reports if a cutter unit is installed.

Supported Devices ZT200 Series

Type `getvar`

Commands	Details
<code>getvar</code>	This command checks if a cutter is installed. <i>Format:</i> ! U1 <code>getvar "device.cutter_installed"</code> <i>Values:</i> Yes or No <i>Default:</i> No



Note •

- For printer support, see [SGD Command Support on page 1267](#).
- For details on SGD command structure, see [Command Structure on page 635](#).

device.download_connection_timeout

Description This command instructs the printer to abort a firmware download if the printer fails to receive any download data in the set amount of seconds. If the set amount of seconds is exceeded, the download will be aborted, and the printer automatically restarts. This command prevents the printer from being locked into the downloading state, if the communication to the host is interrupted. For printer support, see [SGD Command Support on page 1267](#).

Type setvar;getvar

Commands	Details
setvar	<p>This command instructs the printer to abort a firmware download if the printer fails to receive any download data in the set amount of seconds.</p> <p><i>Format:</i> ! U1 setvar "device.download_connection_timeout" "value"</p> <p><i>Values:</i> "0" through "65535"</p> <p><i>Default:</i> "0" ("0" disables this feature)</p>
getvar	<p>This command retrieves the connection time out value (in seconds).</p> <p><i>Format:</i> ! U1 getvar "device.download_connection_timeout"</p>



Note • For details on SGD command structure, see [Command Structure on page 635](#).



Example • This `setvar` example shows the value set to "0".

```
! U1 setvar "device.download_connection_timeout" "0"
```

When the `setvar` value is set to "0", the `getvar` result is "0".

device.ep1_legacy_mode

Description This command places the printer in a 2824/2844 compatibility mode for vertical registration.

Supported Devices

- G-Series printers
- LP2824 Plus and TLP 2824 Plus

Type setvar;getvar

Commands	Details
setvar*	<p>This command instructs the printer to change the ep1_legacy_mode setting.</p> <p><i>Format:</i> ! U1 setvar "device.ep1_legacy_mode" "value"</p> <p><i>Values:</i></p> <ul style="list-style-type: none"> off = ep1_legacy_mode not active registration = EPL legacy registration mode on print orientation = EPL legacy print orientation mode on all = all EPL legacy modes on <p><i>Default Value:</i> "off"</p>
getvar	<p>This command causes the printer to return the current setting for the device.ep1_legacy_mode setting.</p> <p><i>Format:</i> ! U1 getvar "device.ep1_legacy_mode"</p>



Note

- For printer support, see [SGD Command Support on page 1267](#).
- For details on SGD command structure, see [Command Structure on page 635](#).



Example 1 • This setvar example shows the value set to "registration".

```
! U1 setvar "device.ep1_legacy_mode" "registration"
```

Example 2 • This setvar example shows the value set to "print_orientation".

```
! U1 setvar "device.ep1_legacy_mode" "print_orientation"
```

Example 3 • This getvar example shows the response when the value was set to "registration" and "print_orientation".

```
! U1 getvar "device.ep1_legacy_mode"
"registration, print_orientation"
```

Example 4 • This getvar example shows the response when value was set to "all"

```
! U1 getvar "device.ep1_legacy_mode"
"all"
```

These are the possible responses to `getvar "device.epi_legacy_mode"`

- "off"
- "registration"
- "print_orientation"
- "registration, print_orientation"
- "all"



Note • This setting is not defaulted as part of a factory default (^JUF or ^default). The setting is persistent across a power cycle or rest (~JR or device.reset).

When setting the “registration” mode, the "print_orientation" mode is not changed. Likewise, when setting the "print_orientation" mode, the "registration" mode is not changed. Using "off" or "all" changes all modes.

Print Orientation Mode



Note • When the printer is powered on, the print orientation defaults to ^PON (EPL ZB mode). The print orientation setting is not saved across power cycles. This is different than TLP2844, LP2844, TLP2824, LP2824, and TLP3842 printers. Those printers have a default of ZB (ZPL ^PON mode) and the print orientation setting is saved across power cycles. To make the printer have the print orientation behavior of the TLP2844, LP2844, TLP2824, LP2824, and TLP3842 printers, set the epi_legacy_mode to "print_orientation".

Registration Mode



Note • When printing labels using EPL commands, printing starts 1mm from the top edge of the label (from the gap). This is known as the “no print zone”. When printing in ZT mode, the “no print zone” starts at the gap on the leading edge of the label. When printing in ZB mode, the “no print zone” starts from the gap on the trailing edge of the label. In the TLP2844, LP2844, TLP2824, LP2824, and TLP3842 printers, the distance from gap to start of print (the “no print zone”) is not always 1mm.

The table below shows the nominal distance.

Distance from Edge of Label to First Print Line (No Print Zone)			
Legacy Printer Model	New Printer Model	ZT Mode	ZB Mode
LP2844	GX420, GK420 (direct thermal)	1.9 mm	0.0 mm
TLP2844	GX420, GK420 (thermal transfer)	0.4 mm	1.6 mm
TLP3842	GX430 (thermal transfer)	0.0 mm	1.2 mm
LP2824	LP 2824 Plus (direct thermal)	1.5 mm	0.4 mm
TLP2824	TLP 2824 Plus (thermal transfer)	0.1 mm	1.8 mm

- Setting epi_legacy_mode to "registration" selects the distance shown in the table.
- Setting epi_legacy_mode to "off" selects a no print zone distance of 1mm.

device.friendly_name

Description This command shows the name assigned to the printer. For printer support, see [SGD Command Support on page 1267](#).

Type setvar;setvar

Commands	Details
setvar	This command sets the printer's name. <i>Format:</i> ! U1 setvar "device.friendly_name" "value" <i>Default:</i> "xxxxxxxx" ("xxxxxxxx" represents the main logic board serial number)
getvar	This command retrieves the name assigned to the printer. <i>Format:</i> ! U1 getvar "device.friendly_name"



Note • For details on SGD command structure, see [Command Structure on page 914](#).



Example • This `setvar` example shows the value set to "xxxxxxxx".

```
! U1 setvar "device.friendly_name" "xxxxxxxx"
```

When the `setvar` value is set to "xxxxxxxx", the `getvar` result is "xxxxxxxx".

device.frontpanel.feedenabed

Description This command can be used to enable or disable the FEED key or any other key on the printer. For printer support, see *SGD Command Support on page 1267*.

Supported Devices

- GK420
- GX420, GX430, GX420s
- LP/TLP 2824 Plus,

Type setvar;getvar

Commands	Details
setvar	This command instructs the printer to change the front_panel.feedenabed setting. <i>Format:</i> ! U1 setvar "device.frontpanel.feedenabed" <i>Values:</i> "yes" = Front Panel keys are enabled "no" = Front Panel keys are disabled <i>Default:</i> "no" = for GX420s printers "yes" = all supported printers except GX420s <i>Power On Default:</i> "no" = for GX420s printers "yes" = all supported printers except GX420s
getvar	This command retrieves the current setting for the front_panel.feedenabed command: <i>Format:</i> ! U1 getvar "device.frontpanel.feedenabed"



Note • For details on SGD command structure, see *Command Structure on page 635*.



Example • In this example, the setvar sets the value to "no".

```
! U1 setvar "device.frontpanel.feedenabed" "no"
```



Note • On GX420 printers with an LCD display, there is a SCROLL and SELECT key in addition to the FEED key. Both the SCROLL and SELECT keys are enabled or disabled when the FEED key is enabled or disabled using this command.



Note • On power up, for model GX420s printer, the command value is set to "no". For all other printers, on power up, the command value is set to "yes".

device.frontpanel.key_press

Description This command instructs the printer to press a button on the front panel. For printer support, see *SGD Command Support* on page 1267.

Type setvar

Commands	Details								
setvar	<p>This command instructs the printer to press a button on the front panel.</p> <p><i>Format:</i> ! U1 setvar "device.frontpanel.key_press"</p> <p><i>Values:</i> The values vary per printer, as follows:</p> <table border="1" data-bbox="386 667 1406 1352"> <thead> <tr> <th data-bbox="386 667 906 709">ZM400, Z4M/Z6M, and RZ400/RZ600:</th> <th data-bbox="906 667 1406 709">S4M:</th> </tr> </thead> <tbody> <tr> <td data-bbox="386 709 906 982"> "A" = Pause "B" = Feed "C" = Cancel "D" = Setup/Exit "E" = Minus "F" = Select "G" = Plus </td> <td data-bbox="906 709 1406 940"> "A" = Pause "B" = Feed "C" = Up Arrow "D" = Cancel "E" = Menu "F" = Enter </td> </tr> <tr> <th data-bbox="386 982 906 1024">XiIIplus:</th> <th data-bbox="906 940 1406 982">Xi4, RXi4:</th> </tr> <tr> <td data-bbox="386 1024 906 1352"> "A" = Pause "B" = Feed "C" = Cancel "D" = Setup/Exit "E" = Previous "F" = Next/Save "G" = Minus "H" = Plus "I" = Calibrate </td> <td data-bbox="906 982 1406 1352"> "A" = Pause "B" = Feed "C" = Cancel "D" = Setup/Exit "E" = Previous "F" = Next/Save "G" = Minus "H" = Plus "I" = Calibrate </td> </tr> </tbody> </table>	ZM400, Z4M/Z6M, and RZ400/RZ600:	S4M:	"A" = Pause "B" = Feed "C" = Cancel "D" = Setup/Exit "E" = Minus "F" = Select "G" = Plus	"A" = Pause "B" = Feed "C" = Up Arrow "D" = Cancel "E" = Menu "F" = Enter	XiIIplus:	Xi4, RXi4:	"A" = Pause "B" = Feed "C" = Cancel "D" = Setup/Exit "E" = Previous "F" = Next/Save "G" = Minus "H" = Plus "I" = Calibrate	"A" = Pause "B" = Feed "C" = Cancel "D" = Setup/Exit "E" = Previous "F" = Next/Save "G" = Minus "H" = Plus "I" = Calibrate
ZM400, Z4M/Z6M, and RZ400/RZ600:	S4M:								
"A" = Pause "B" = Feed "C" = Cancel "D" = Setup/Exit "E" = Minus "F" = Select "G" = Plus	"A" = Pause "B" = Feed "C" = Up Arrow "D" = Cancel "E" = Menu "F" = Enter								
XiIIplus:	Xi4, RXi4:								
"A" = Pause "B" = Feed "C" = Cancel "D" = Setup/Exit "E" = Previous "F" = Next/Save "G" = Minus "H" = Plus "I" = Calibrate	"A" = Pause "B" = Feed "C" = Cancel "D" = Setup/Exit "E" = Previous "F" = Next/Save "G" = Minus "H" = Plus "I" = Calibrate								



Note • For details on SGD command structure, see *Command Structure* on page 635.



Example • This setvar example shows the value set to "A".
! U1 setvar "device.frontpanel.key_press" "A"

device.frontpanel.line1

Description This command overrides the content that is shown on the first line of the front panel when the printer is showing the idle display. Use of the `getvar` function is dependent on first using the `setvar` function. For example, to have the first line of the idle display to show HELLO, you must first send a `setvar` command; then a `getvar` command can be sent to retrieve the value HELLO. For printer support, see [SGD Command Support on page 1267](#). For details on the supported character set, see [Character Set on page 1264](#).

Type `setvar;getvar`

Commands	Details
<code>setvar</code>	<p>This command instructs the printer to set the content that is shown on line one of the front panel.</p> <p><i>Format:</i></p> <pre>! U1 setvar "device.frontpanel.line1" "value"</pre> <p><i>Values:</i> The maximum amount of alphanumeric ASCII characters available for line 1 on the printer's front panel</p> <p><i>Default:</i> ""</p>
<code>getvar</code>	<p>This command retrieves the content that is shown on line one of the front panel.</p> <p><i>Format:</i> <code>! U1 getvar "device.frontpanel.line1"</code></p>



Note • For details on SGD command structure, see [Command Structure on page 635](#).



Example • This `setvar` example shows the value set to "sample line 1".

```
! U1 setvar "device.frontpanel.line1" "sample line 1"
```

When the `setvar` value is set to "sample line 1", the `getvar` result is "sample line 1".

device.frontpanel.line2

Description This command overrides the content that is shown on the second line of the front panel when the printer is showing the idle display. Use of the `getvar` function is dependent on using the `setvar` function. For example, to have the second line of the idle display show HELLO, you must first send a `setvar` command; then a `getvar` command can be sent to retrieve the value HELLO. For printer support, see [SGD Command Support on page 1267](#). For details on the supported character set, see [Character Set on page 1264](#).

Type `setvar;getvar`

Commands	Details
<code>setvar</code>	<p>This command instructs the printer to set the content that shows on line two of the front panel.</p> <p><i>Format:</i></p> <pre>! U1 setvar "device.frontpanel.line2" "value"</pre> <p><i>Values:</i> The maximum amount of alphanumeric ASCII characters available for line two on the printer's front panel</p> <p><i>Default:</i> ""</p>
<code>getvar</code>	<p>This command retrieves the content that shows on line two of the front panel.</p> <p><i>Format:</i> <code>! U1 getvar "device.frontpanel.line2"</code></p>



Note • For details on SGD command structure, see [Command Structure on page 635](#).



Example • This `setvar` example shows the value set to "sample line 2".

```
! U1 setvar "device.frontpanel.line2" "sample line 2"
```

When the `setvar` value is set to "sample line 2", the `getvar` result is "sample line 2".

device.frontpanel.xml

Description This command retrieves the current content of the front panel in an XML format. For printer support, see *SGD Command Support* on page 1267.

Type `getvar`

Commands	Details
<code>getvar</code>	This command retrieves the file that determines the representation of the front panel. <i>Format:</i> <code>! U1 getvar "device.frontpanel.xml"</code>



Note • For details on SGD command structure, see *Command Structure* on page 635.



Example • In this example, the `getvar` shows the status of the LEDs and the two lines of the front panel in XML formatted text. The text below is formatted for easy reading. When you use this command the response will not contain line feeds.

```
! U1 getvar "device.frontpanel.xml"

<FRONT-PANEL>
  <LCD>
    <LINE1>PRINTER READY</LINE1>
    <LINE2>V53.16.0</LINE2>
  </LCD>
  <LEDS>
    <PAUSE-LED>STEADY-OFF</PAUSE-LED>
    <DATA-LED>STEADY-OFF</DATA-LED>
    <ERROR-LED>STEADY-OFF</ERROR-LED>
  </LEDS>
</FRONT-PANEL>
```

device.host_identification

Description This command is designed to be sent from the host to the Zebra printer to retrieve information. Upon receipt, the printer responds with information on the model, software version, dots-per-millimeter setting, memory size, and any detected options.

This command is equivalent to the `~HI ZPL` command.

Supported Devices ZT200 Series

Type `getvar`

Commands	Details
<code>getvar</code>	<p>This command displays information about the printer.</p> <p><i>Format:</i> ! U1 <code>getvar "device.host_identification"</code></p> <p><i>Result:</i> <code>XXXXXX,V1.0.0,dpm,000KB,X</code></p> <p><i>Values:</i></p> <ul style="list-style-type: none"> XXXXXX = model of Zebra printer V1.0.0 = version of software dpm = dots/mm 6, 8, 12, or 24 dots/mm printheads 000KB = memory <ul style="list-style-type: none"> 512KB = 1/2 MB 1024KB = 1 MB 2048KB = 2 MB 4096KB = 4 MB 8192KB = 8 MB x = recognizable options only options specific to printer are shown (cutter, options, et cetera.)



Note •

- For printer support, see [SGD Command Support on page 1267](#).
- For details on SGD command structure, see [Command Structure on page 635](#).

device.host_status

Description When this command is sent to the printer, the printer sends three data strings back. To avoid confusion, the host prints each string on a separate line.

This command is similar to the `~HS` ZPL command.

The response for this SGD command does not include the `STX` at the beginning of each data line and does not include the `ETX` at the end of each data line as found in the `~HS` response. Additionally, the first and second response lines for the SGD command contain a `CR/LF` at the end of each line.



Note • When the command is sent, the printer will not send a response to the host if the printer is in one of these conditions:

- MEDIA OUT
- RIBBON OUT
- HEAD OPEN
- REWINDER FULL
- HEAD OVER-TEMPERATURE

Supported Devices ZT200 Series

Type `getvar`

Commands	Details
<code>getvar</code>	<p><i>Format:</i> ! U1 <code>getvar "device.host_status"</code></p> <p><i>Result:</i> Three strings, each on their own line.</p> <pre>"aaa,b,c,dddd,eee,f,g,h,iii,j,k,l mmm,n,o,p,q,r,s,t,uuuuuuuu,v,www xxxx,y"</pre> <p><i>Values:</i> See definitions for String 1, String 2, and String 3 below.</p>

String 1 "aaa,b,c,dddd,eee,f,g,h,iii,j,k,l"

- aaa = communication (interface) settings ^a
- b = paper out flag (1 = paper out)
- c = pause flag (1 = pause active)
- dddd = label length (value in number of dots)
- eee = number of formats in receive buffer
- f = *buffer full* flag (1 = receive buffer full)
- g = *communications diagnostic mode* flag (1 = diagnostic mode active)
- h = *partial format* flag (1 = partial format in progress)
- iii = unused (always 000)
- j = *corrupt RAM* flag (1 = configuration data lost)
- k = temperature range (1 = under temperature)
- l = temperature range (1 = over temperature)

a. This string specifies the printer's baud rate, number of data bits, number of stop bits, parity setting, and type of handshaking. This value is a three-digit decimal representation of an eight-bit binary number. To evaluate this parameter, first convert the decimal number to a binary number.

The nine-digit binary number is read according to this table:

aaa = a ⁸ a ⁷ a ⁶ a ⁵ a ⁴ a ³ a ² a ¹ a ⁰	
a ⁷ = Handshake 0 = Xon/Xoff 1 = DTR	a ⁸ a ² a ¹ a ⁰ = Baud 0 000 = 110 0 001 = 300 0 010 = 600 0 011 = 1200 0 100 = 2400 0 101 = 4800 0 110 = 9600 0 111 = 19200 1 000 = 28800 <i>(available only on certain printer models)</i> 1 001 = 38400 <i>(available only on certain printer models)</i> 1 010 = 57600 <i>(available only on certain printer models)</i> 1 011 = 14400
a ⁶ = Parity Odd/Even 0 = Odd 1 = Even	
a ⁵ = Disable/Enable 0 = Disable 1 = Enable	
a ⁴ = Stop Bits 0 = 2 Bits 1 = 1 Bit	
a ³ = Data Bits 0 = 7 Bits 1 = 8 Bits	

String 2 "mmm,n,o,p,q,r,s,t,uuuuuuuu,v,www"

mmm	=	function settings ^b
n	=	unused
o	=	<i>head up</i> flag (1 = head in up position)
p	=	<i>ribbon out</i> flag (1 = ribbon out)
q	=	<i>thermal transfer mode</i> flag (1 = Thermal Transfer Mode selected)
r	=	Print Mode
		0 = Rewind
		1 = Peel-Off
		2 = Tear-Off
		3 = Cutter
		4 = Applicator
		5 = Delayed cut
		6 = Reserved ^c
		7 = Reserved ^c
		8 = Reserved ^c
		9 = RFID
s	=	print width mode
t	=	<i>label waiting</i> flag (1 = label waiting in Peel-off Mode)
uuuuuuuu	=	labels remaining in batch
v	=	<i>format while printing</i> flag (always 1)
www	=	number of graphic images stored in memory



Values 4 to 5 are only supported in firmware version V60.14.x, V50.14.x, V53. 15.x, or later.

- b. This string specifies the printer's media type, sensor profile status, and communication diagnostics status. As in String 1, this is a three-digit decimal representation of an eight-bit binary number. First, convert the decimal number to a binary number.
- c. These values are only supported on the Xi4, RXi4, ZM400/ZM600, RZ400/RZ600, and ZT200 Series printers.

The eight-digit binary number is read according to this table:

mmm = m7 m6 m5 m4 m3 m2 m1 m0	
m7 = Media Type 0 = Die-Cut 1 = Continuous	m4 m3 m2 m1 = Unused 0 = Off 1 = On
m6 = Sensor Profile 0 = Off	m0 = Print Mode 0 = Direct Thermal 1 = Thermal Transfer
m5 = Communications Diagnostics 0 = Off 1 = On	

String 3 "xxxx,y"

xxxx	=	password
y	=	0 (static RAM not installed)
		1 (static RAM installed)



Note •

- For printer support, see [SGD Command Support on page 1267](#).
- For details on SGD command structure, see [Command Structure on page 635](#).



device.internal_wired_setting_location

Description This command identifies the location from where internal_wired network specific settings should be retrieved.

Supported Devices

- ZT200™ series
- ZD500™ series
- QLn™ series

Type setvar;getvar

Commands	Details
setvar*	<p>This command specifies the location from where internal_wired network specific settings should be retrieved.</p> <p><i>Format:</i> ! U1 setvar "device.internal_wired_setting_location" "value"</p> <p><i>Values:</i></p> <p style="padding-left: 20px;">"network card"</p> <p style="padding-left: 20px;">"printer"</p> <p> Note • "printer" is the only valid option for the QLn series and ZD500 series printers.</p> <p><i>Default Value:</i> "network_card"</p>
getvar	<p>This command displays the location where internal_wired network specific settings are retrieved from.</p> <p><i>Format:</i> ! U1 getvar "device.internal_wired_setting_location"</p> <p> Note • "printer" is the only valid getvar option for the QLn series and ZD500 series printers.</p>



Note • For details on SGD command structure, see [Command Structure on page 635](#).
For printer support, see [SGD Command Support on page 1267](#).

device.jobs_print

Description This command identifies the number of jobs to be printed. For printer support, see [SGD Command Support on page 1267](#).

Type getvar

Commands	Details
getvar	This command retrieves the number of jobs to be printed. <i>Format: ! U1 getvar "device.jobs_print"</i>



Note • For details on SGD command structure, see [Command Structure on page 635](#).





Example • In this example, the `getvar` retrieves the jobs currently being printed or last printed.

```
! U1 getvar "device.jobs_print"  
  
"1"
```

device.languages

Description This command identifies the programming language that the printer is currently using.

Type setvar;setvar

Commands	Details
setvar	<p>This command instructs the printer to set the printer to the required programming language.</p> <p><i>Format:</i> ! U1 setvar "device.languages" "value"</p> <p><i>Values:</i></p> <ul style="list-style-type: none"> "ep1" = Eltron Programming Language "ep1_zpl" = Eltron Programming Language and Zebra Programming Language "zpl" = Zebra Programming Language "hybrid_xml_zpl" = XML and ZPL Programming Languages "apl-d" = Virtual Device-D (only Link-OS printers) "apl-t" = Virtual Device-T (only desktop and table top printers with Link-OS) "apl-e" = Virtual Device-E (only mobile printers with Link-OS) "apl-o" = Virtual Device-O (only mobile printers with Link-OS) "apl-i" = Virtual Device-I (only Link-OS printers) <p> Important • Not all values are accepted on all printers. Use the ! U1 getvar "allcv" command to see the range of values that your printer supports. Values other than those listed may be available depending on the firmware version being used.</p> <p> Note • "zpl" and "hybrid_xml_zpl" are equivalent. When the setvar is set to "zpl", the getvar result will always be "hybrid_xml_zpl".</p> <p><i>Default Value:</i> "ep1_zpl"</p>
getvar	<p>This command retrieves the programming language that the printer is currently using.</p> <p><i>Format:</i> ! U1 getvar "device.languages"</p>



Example • This setvar example sets the programming language to "hybrid_xml_zpl" using the shorter value of "zpl".

```
! U1 setvar "device.languages" "zpl"
```



Note •

- For printer support, see [SGD Command Support on page 1267](#).
- For details on SGD command structure, see [Command Structure on page 635](#).

device.light.cover_open_brightness

Description This command sets the brightness level for the Cover Open light.

Type setvar;setvar

Supported Devices ZT400 series

Commands	Details
setvar	Sets the brightness level for the cover open LEDs. <i>Format:</i> ! U1 setvar "device.light.cover_open_brightness" "value" <i>Values:</i> "high" = the LEDs display at maximum brightness when the cover is open "medium" = the LEDs display at medium brightness when the cover is open "low" = the LEDs display at lowest brightness when the cover is open "off" = the LEDs remain off at all times <i>Default:</i> "high"
getvar	Retrieves the current brightness level setting for the cover open LEDs. <i>Format:</i> ! U1 getvar "device.light.cover_open_brightness"



Example • This setvar example shows the value set to "low".
! U1 setvar "device.light.cover_open_brightness" "low"



Note •

- For printer support, see [SGD Command Support on page 1267](#).
- For details on SGD command structure, see [Command Structure on page 635](#).

device.light.head_open_brightness

Description This command sets the brightness level for the Head Open light.

Type setvar;getvar

Supported Devices ZT400 series

Commands	Details
setvar	<p>Sets the brightness level for the head open LEDs.</p> <p><i>Format:</i> ! U1 setvar "device.light.head_open_brightness" "value"</p> <p><i>Values:</i></p> <ul style="list-style-type: none"> "high" = the LEDs display at maximum brightness when the head is open "medium" = the LEDs display at medium brightness when the head is open "low" = the LEDs display at lowest brightness when the head is open "off" = the LEDs remains off at all times <p><i>Default:</i> "high"</p>
getvar	<p>Retrieves the current brightness level setting for the head open LEDs.</p> <p><i>Format:</i> ! U1 getvar "device.light.head_open_brightness"</p>



Example • This setvar example shows the value set to "medium".

```
! U1 setvar "device.light.head_open_brightness" "medium"
```



Note •

- For printer support, see [SGD Command Support on page 1267](#).
- For details on SGD command structure, see [Command Structure on page 635](#).

device.ltu_installed

Description This command checks to see if a Liner Take-Up unit is installed.

Supported Devices ZT200 Series

Type getvar

Commands	Details
getvar	<i>Format:</i> ! U1 getvar "device.ltu_installed" <i>Values:</i> Yes No <i>Default:</i> No



Note •

- For printer support, see [SGD Command Support on page 1267](#).
- For details on SGD command structure, see [Command Structure on page 635](#).

device.orientation

Description This printer setting determines the installation orientation of the KR403 printer, either horizontal or vertical. It is intended for use only by the system integrator. Modification by an end user can result in unexpected printer behaviour.

Supported Devices

- KR403

Type setvar;getvar

Commands	Details
setvar	<p>This command instructs the printer to change the presenter loop length.</p> <p><i>Format:</i> ! U1 setvar "device.orientation" "value"</p> <p><i>Values:</i></p> <ul style="list-style-type: none"> 0 = printer is installed horizontally 1 = is installed vertically <p><i>Default:</i></p> <p>0 = printer is installed horizontally (original factory default only, value will not change when defaulting the printer with ^JUF)</p>
getvar	<p>This command instructs the printer to respond with the currently set presenter loop length.</p> <p><i>Format:</i> ! U1 getvar "device.orientation"</p>



Note • For details on SGD command structure, see [Command Structure on page 635](#).

device.pause

Description This command stops printing after the current label is complete (if one is printing) and places the printer in Pause Mode.

This command is equivalent to ~PP.

Supported Devices ZT200 Series

Type setvar;do

Commands	Details
setvar	This command stops printing and puts the printer in Pause Mode. <i>Format:</i> ! U1 SETVAR "device.pause" "" <i>Values:</i> NA <i>Default:</i> NA
do	This command stops printing and puts the printer in Pause Mode. <i>Format:</i> ! U1 DO "device.pause" "" <i>Values:</i> NA <i>Default:</i> NA



Note •

- For printer support, see [SGD Command Support](#) on page 1267.
- For details on SGD command structure, see [Command Structure](#) on page 635.

device.pnp_option

Description This command defines the type of Plug and Play response that is sent by the printer after the printer is started. The printer must be restarted for a new PNP string to be reported. For printer support, see [SGD Command Support on page 1267](#).

Type setvar;getvar

Commands	Details
setvar	This command instructs the printer to select the desired Plug and Play response option. <i>Format:</i> ! U1 setvar "device.pnp_option" "value" <i>Values:</i> "ep1" = Eltron Programming Language "zpl" = Zebra Programming Language <i>Default:</i> "zpl"
getvar	This command retrieves the Plug and Play option setting. <i>Format:</i> ! U1 getvar "device.pnp_option"



Note • For details on SGD command structure, see [Command Structure on page 635](#).



Example • This `setvar` example shows the value set to "zpl".

```
! U1 setvar "device.pnp_option" "ep1"
```

When the `setvar` value is set to "ep1", the `getvar` result is "ep1".

device.position.accuracy

Description This printer setting retrieves/sets the accuracy of the geographic position values.

The units of the value depend upon the location provider that was used to determine the geographic coordinates. Usually, this is specified as a radius, in meters, of confidence around the location coordinates. Often, the radius represents a radius of 68% confidence that the true location lies within the circle, representing one standard deviation.



Note • These settings hold the value to which they are set, within the range restrictions. The printer does not perform any calculations, nor associate any meaning such as “meters” or “feet” to the values. The values can be determined by a number of methods, including an Android® or iOS® application communicating with the printer using the smart phone’s geolocation device.

Supported Devices

Type setvar;getvar

Commands	Details
setvar	<p>This command sets the accuracy of the geographic position values.</p> <p><i>Format:</i> ! U1 setvar "device.position.accuracy" "value"</p> <p><i>Values:</i> A decimal number with 6 decimal places, e.g. 25.370000. The value is saved as a double precision floating point number.</p> <ul style="list-style-type: none"> • Minimum: 0 • Maximum: 406700000
getvar	<p>This command retrieves the accuracy of the geographic position values.</p> <p><i>Format:</i> ! U1 getvar "device.position.accuracy"</p>



Example •

```
! U1 setvar "device.position.accuracy" "25.37"
```



Note • For details on SGD command structure, see [Command Structure](#) on page 635.

device.position.altitude

Description This printer setting retrieves the altitude above sea level.

The value is in meters above sea level. A positive number indicates a position above sea level. A negative number indicates a position below sea level. The position of sea level depends upon the system used to provide a nominal sea level reference position. This is often the World Geodetic System WGS 84 standard but depends upon the location provider.

Supported Devices

Type setvar;setvar

Commands	Details
setvar	This command sets the altitude of the printer above sea level. <i>Format:</i> ! U1 setvar "device.position.altitude" "value" <i>Values:</i> A decimal number with 6 decimal places, e.g. 305.100000 The value is saved as a double precision floating point number. <ul style="list-style-type: none">• Minimum: -10000• Maximum: 406700000 <i>Default:</i> 0.0
getvar	This command retrieves the altitude above sea level. <i>Format:</i> ! U1 getvar "device.position.altitude"



Example •

```
! U1 setvar "device.position.altitude" "305.1"
```



Note • For details on SGD command structure, see [Command Structure](#) on page 635.

device.position.latitude

Description This printer setting retrieves/sets the geographic latitudinal position.

Supported Devices

Type setvar;getvar

Commands	Details
setvar	This command sets the latitude position of the printer. <i>Format:</i> ! U1 setvar "device.position.latitude" "value" <i>Values:</i> The value is in decimal degrees from 0.0 to +/-90.0. <i>Default:</i> 0.0
getvar	This command retrieves the latitude position of the printer. <i>Format:</i> ! U1 getvar "device.position.latitude" <i>Values:</i> The value is returned with 6 decimal places. A value of 0.000001 degree is on the order of 0.1 meter of distance on the earth's surface. (The correspondence between degrees and length on the earth's surface varies because the earth is an irregular ellipsoid.)



Example •

```
! U1 setvar "device.position.latitude" "6.123456"
```



Note • For details on SGD command structure, see [Command Structure](#) on page 635.

device.position.longitude

Description This printer setting retrieves/sets the geographic longitudinal position.

Supported Devices

Type setvar;getvar

Commands	Details
setvar	<p>This command sets the longitudinal position of the printer.</p> <p><i>Format:</i> ! U1 setvar "device.position.longitude" "value"</p> <p><i>Values:</i> The value is in decimal degrees from 0.0 to +/-180.0. The value is saved as a double precision floating point number.</p> <p><i>Default:</i> 0.0</p>
getvar	<p>This command retrieves the longitudinal position of the printer. .</p> <p><i>Format:</i> ! U1 getvar "device.position.longitude"</p> <p><i>Values:</i> The value is returned with 6 decimal places. A value of 0.000001 degree is on the order of no more than 0.1 meter of distance on the earth's surface. (The correspondence between degrees and length on the earth's surface varies from approximately 0.1 meter at the equator to 0.0 at the poles.)</p>



Example •

```
! U1 setvar "device.position.longitude" "25.123456"
```



Note • For details on SGD command structure, see [Command Structure](#) on page 635.

device.print_reprogram_2key

Description This command determines whether the printer will print a configuration label or 2key report after the printer restarts following a firmware update.

When set to "off" the printer will not print the configuration label or 2key report after the printer is updated.

Supported Devices ZT200 Series

Type setvar;setvar

Commands	Details
setvar	<p>This command sets whether a two-key report is printed or not.</p> <p><i>Format:</i> ! U1 setvar "device.print_reprogram_2key" "value"</p> <p><i>Values:</i></p> <p> "yes"</p> <p> "no"</p> <p><i>Default:</i> "no"</p>
getvar	<p>This command retrieves the current setting for processing two-key report after printer firmware is reprogrammed.</p> <p><i>Format:</i> ! U1 getvar "device.print_reprogram_2key"</p> <p><i>Result:</i></p> <p> yes</p> <p> no</p>



Example • This example disables printing of the two-key report after printer firmware is reprogrammed.

```
! U1 setvar "device.print_reprogram_2key" "no"
```



Note •

- For printer support, see [SGD Command Support on page 1267](#).
- For details on SGD command structure, see [Command Structure on page 635](#).

device.reset

Description This command instructs the printer to perform a soft reset. For printer support, see [SGD Command Support on page 1267](#).

Type setvar

Commands	Details
setvar	This command instructs the printer to perform a soft reset. <i>Format:</i> ! U1 setvar "device.reset" ""



Note • For details on SGD command structure, see [Command Structure on page 914](#).



Example • In this example, the `setvar` performs a soft reset.

```
! U1 setvar "device.reset" ""
```

device.restore_defaults

Description This command restores to the default of all settings within the specified SGD branch. For printer support, see *SGD Command Support on page 1267*.

Type setvar;do

Commands	Details
setvar	<p>This command restores to the default of all settings within the specified branch.</p> <p><i>Format:</i> ! U1 setvar "device.restore_defaults" "value"</p> <p><i>Values:</i></p> <ul style="list-style-type: none"> "ip" = default all parameters in the IP branch "wlan" = default all parameters in the wlan branch "internal_wired" = default all parameters in the internal wired branch
do	<p>This command restores the default setting for all items within the specified branch.</p> <p><i>Format:</i> ! U1 do "device.restore_defaults" "value"</p> <p><i>Values:</i></p> <ul style="list-style-type: none"> "ip" = default all parameters in the ip branch "wlan" = default all parameters in the wlan branch "internal_wired" = default all parameters in the internal wired branch



Note • For details on SGD command structure, see *Command Structure on page 969*.



Example • These `do` and `setvar` examples restore the network card's wlan parameters to their default values.

```
do ! U1 do "device.restore_defaults" "wlan"

setvar ! U1 setvar "device.restore_defaults" "wlan"
```

device.slot_1

Description This command retrieves the type of board installed in the bottom slot of a ZT400 series printer, or in the single expansion slot of a ZT200 series printer.

Type `getvar`

Supported Devices

- ZT400 series
- ZT200 series

Commands	Details
<code>getvar</code>	<p>This command retrieves the type of board installed in the bottom slot of a ZT400 series printer, or the expansion slot of a ZT200 series printer..</p> <p><i>Format:</i> ! U1 <code>getvar "device.slot_1"</code></p> <p><i>Values:</i></p> <ul style="list-style-type: none"> "empty" = no board installed "parallel" = a parallel communications board is installed "wired" = a wired PrintServer board is installed "wireless" = a wireless PrintServer board is installed



Note •

- For printer support, see [SGD Command Support on page 1267](#).
- For details on SGD command structure, see [Command Structure on page 635](#).

device.slot_2

Description This command retrieves the type of board installed in the bottom slot of a ZT400 series printer.

Type `getvar`

Supported Devices ZT400 series

Commands	Details
<code>getvar</code>	<p>This command retrieves the type of board installed in the bottom slot.</p> <p><i>Format:</i> ! U1 <code>getvar "device.slot_2"</code></p> <p><i>Values:</i></p> <ul style="list-style-type: none">"empty" = no board installed"parallel" = a parallel communications board is installed"wired" = a wired PrintServer board is installed"wireless" = a wireless PrintServer board is installed



Note •

- For printer support, see [SGD Command Support on page 1267](#).
- For details on SGD command structure, see [Command Structure on page 635](#).

device.super_host_status

Description This command returns printer description information in XML format. The printer returns information on format parameters, object directories, individual object data, and print status information.

This command is equivalent to the ^HZA ZPL command.

Supported Devices ZT200 Series

Type getvar

Commands	Details
getvar	<i>Format:</i> ! U1 getvar "device.super_host_status" <i>Result:</i> Information on format parameters, object directories, individual object data, and print status information.



Note •

- For printer support, see [SGD Command Support on page 1267](#).
- For details on SGD command structure, see [Command Structure on page 635](#).

device.syslog.clear_log

Description This setting clears the local syslog entries SGD. Any log messages previously sent to an ip address are not changed.

Type setvar;do

Supported Devices Link-OS printers with firmware Vxx.19.7Z and later.

Commands	Details
setvar	Clears the local syslog file. <i>Format:</i> ! U1 setvar "device.syslog.clear_log" "" <i>Values:</i> NA <i>Default:</i> NA
do	Clears the local syslog file. <i>Format:</i> ! U1 do "device.syslog.clear_log" "" <i>Values:</i> NA <i>Default:</i> NA



Note •

- For printer support, see [SGD Command Support on page 1267](#).
- For details on SGD command structure, see [Command Structure on page 635](#).

device.syslog.configuration

Description This setting specifies the location for the syslog messages to be recorded. The location may be either on the printer, or a syslog server IP address.

Type setvar; getvar

Supported Devices Link-OS printers with firmware Vxx.19.7Z and later.

Commands	Details
setvar	<p>Specifies the location for the syslog messages to be recorded.</p> <p><i>Format:</i> ! U1 setvar "device.syslog.configuration" "value"</p> <p><i>Values:</i> A list of configuration entries, limited to 1000 characters. Entries must be in the form of "severity,destination" and delimited with a semi-colon.</p> <ul style="list-style-type: none"> SEVERITY - The severity levels, in decreasing severity order, are: <ul style="list-style-type: none"> emerg alert crit err warning notice info debug <p>When you specify the severity level, the lowest specified severity and all severity levels above it will be recorded. For example, if you specify <code>debug</code>, you will get all severity level reports. If you specify <code>crit</code>, you will get only <code>crit</code>, <code>alert</code>, and <code>emerg</code> severity reports.</p> <ul style="list-style-type: none"> DESTINATION - "local" or a syslog server IP address <p> Note • When configuring the local syslog report, the first local entry is used and duplicate requests to local are ignored. To configure remote syslog messages you will first need a syslog server to accept them.</p> <p><i>Default:</i> ""</p>
getvar	<p>Retrieves the configuration string setting.</p> <p><i>Format:</i> ! U1 getvar "device.syslog.configuration"</p>

➔ **Example 1** • This example has emergency syslog messages being sent to an IP location, debug (and all higher severity) syslog messages to another IP address, and critical and higher syslog messages to local storage (either a file or SGD).

```
! U1 setvar "device.syslog.configuration"
"emerg,128.168.0.1;debug,192.168.0.2;crit,local;"
```

➔ **Example 2** • This example will only report emergency syslog messages to the local file, and ignore the duplicate location request for critical and higher reports.

```
! U1 setvar "device.syslog.configuration" "emerg,local;crit,local;"
```

➔ **Example 3** • This is an example of a syslog report stored at E:SYSLOG.TXT. Note that `device.syslog.save_local_file` must be enabled.

```
Feb 17 14:28:17: [Power][Informational][0X14] Power On
Feb 17 14:28:19: [Print][Informational][0XF] PQ Job Completed
Feb 17 14:28:20: [Print][Informational][0XF] PQ Job Completed
Feb 17 14:28:20: [Weblink][Informational][0X1005] Weblink disabled
Feb 17 14:28:34: [Network][Notice][0X1C] Cold Start
```

➔ **Example 4** • This is an example of a syslog report from a syslog server application monitoring an IP address.

Received	Source IP	Source Name	Facility	Severity	Timestamp	Tag	Origin	Message
3/17/2014 4:13:59.590 PM	3.5.62	18j131600029	local 0	Notice	Feb 09 19:42:33			[Print][Notice][0XE] Printer Unpaused
3/17/2014 4:13:57.365 PM	3.5.62	18j131600029	local 0	Notice	Feb 09 19:42:31			[Print][Notice][0X8] Head Closed
3/17/2014 4:13:56.237 PM	3.5.62	18j131600029	local 0	Warning	Feb 09 19:42:30			[Print][Warning][0XA] Ribbon In
3/17/2014 4:13:56.230 PM	3.5.62	18j131600029	local 0	Notice	Feb 09 19:42:30			[Print][Notice][0XD] Printer Paused
3/17/2014 4:13:56.224 PM	3.5.62	18j131600029	local 0	Error	Feb 09 19:42:30			[Print][Error][0X7] Head Open



Note •

- For printer support, see [SGD Command Support](#) on page 1267.
- For details on SGD command structure, see [Command Structure](#) on page 635.

device.syslog.enable

Description This printer setting enables syslog messages.



Important • The destination of syslog messages is specified in [device.syslog.configuration](#).

Type setvar; getvar

Supported Devices Link-OS printers with firmware Vxx.19.7Z and later.

Commands	Details
setvar	Enables or disables syslog. <i>Format:</i> ! U1 setvar "device.syslog.enable" "value" <i>Values:</i> "on" "off" <i>Default:</i> "off"
getvar	Displays whether syslog is enabled. <i>Format:</i> ! U1 getvar "device.syslog.enable"



Example • This setvar example shows the value set to "on".

```
! U1 setvar "device.syslog.enable" "on"
```



Note •

- For printer support, see [SGD Command Support](#) on page 1267.
- For details on SGD command structure, see [Command Structure](#) on page 635.

device.syslog.entries

Description This printer setting displays previously sent syslog messages. If there are no previously sent syslog messages, an empty string is returned.



Important • The destination of syslog messages is specified in [device.syslog.configuration](#).

Type `getvar`

Supported Devices Link-OS printers with firmware Vxx.19.7Z and later.

Commands	Details
<code>getvar</code>	<p>Displays previously sent syslog messages.</p> <p><i>Format:</i> <code>! U1 getvar "device.syslog.entries"</code></p> <p>The format of each syslog message includes the printer feature, the severity level, the unique message code, and the unique English message. This allows for more advanced systems administrators to filter particular messages of interest. Syslog currently supports unique messages for most printer alerts, WebLink, and some USB Host messages.</p>



Example • This `getvar` example shows the value of the syslog file.

```
! U1 getvar "device.syslog.entries"
returns
Feb 17 14:28:17: [Power][Informational][0X14] Power On
Feb 17 14:28:19: [Print][Informational][0XF] PQ Job Completed
Feb 17 14:28:20: [Print][Informational][0XF] PQ Job Completed
Feb 17 14:28:20: [Weblink][Informational][0X1005] Weblink disabled
Feb 17 14:28:34: [Network][Notice][0X1C] Cold Start
```



Note •

- For printer support, see [SGD Command Support on page 1267](#).
- For details on SGD command structure, see [Command Structure on page 635](#).

device.syslog.log_max_file_size

Description This printer setting specifies the maximum size of the local syslog file.

Type setvar;getvar

Supported Devices Link-OS printers with firmware Vxx.19.7Z and later.

Commands	Details
setvar	<p>Sets the maximum syslog file size to the specified value.</p> <p><i>Format:</i> ! U1 setvar "device.syslog.log_max_file_size" "value"</p> <p><i>Values:</i> A numerical value between 10000 and 400000</p> <p><i>Default:</i> "10000"</p>
getvar	<p>Returns the maximum allowed size of the syslog file.</p> <p><i>Format:</i> ! U1 getvar "device.syslog.log_max_file_size"</p>



Example • This setvar example shows the value set to "200000".

```
! U1 setvar "device.syslog.log_max_file_size" "200000"
```



Note •

- For printer support, see [SGD Command Support on page 1267](#).
- For details on SGD command structure, see [Command Structure on page 635](#).

device.syslog.save_local_file

Description This command saves the contents of the local syslog to E:SYSLOG.TXT.



Important • The local destination must be specified in [device.syslog.configuration](#).

Type setvar;getvar

Supported Devices Link-OS printers with firmware Vxx.19.7Z and later.

Commands	Details
setvar	Specifies whether to save the contents of the local syslog file to E:SYSLOG.TXT. <i>Format:</i> ! U1 setvar "device.syslog.save_local_file" "value" <i>Values:</i> "yes" = the local syslog is saved to E:SYSLOG.TXT "no" = the local syslog is not saved <i>Default:</i> "no"
getvar	Displays the setting for saving the local syslog file to E:SYSLOG.TXT. <i>Format:</i> ! U1 getvar "device.syslog.save_local_file"



Example • This setvar example shows the value set to "yes".

```
! U1 setvar "device.syslog.save_local_file" "yes"
```



Note •

- For printer support, see [SGD Command Support on page 1267](#).
- For details on SGD command structure, see [Command Structure on page 635](#).

device.unique_id

Description This command retrieves the printer identifier. For printer support, see [SGD Command Support on page 1267](#).

Type getvar

Commands	Details
getvar	This command retrieves the established printer identifier. <i>Format: ! U1 getvar "device.unique_id"</i>



Note • For details on SGD command structure, see [Command Structure on page 635](#).



Example • In this example, assuming the printer’s unique ID is 12345, the `getvar` shows "12345".

```
! U1 getvar "device.unique_id"
```

device.unpause

Description This command causes a printer in Pause Mode to resume printing. The operation is identical to pressing PAUSE on the control panel of the printer when the printer is already in Pause Mode.

This command is equivalent to ~PS.

Supported Devices ZT200 Series

Type setvar; do

Commands	Details
setvar	<i>Format:</i> ! U1 SETVAR "device.pause" "" <i>Values:</i> NA <i>Default:</i> NA
do	<i>Format:</i> ! U1 DO "device.unpause" "" <i>Values:</i> NA <i>Default:</i> NA



Note •

- For printer support, see [SGD Command Support on page 1267](#).
- For details on SGD command structure, see [Command Structure on page 635](#).

device.uptime

Description This command identifies the amount of time the printer has been powered on. The string format is: xx days, xx hours, xx minutes, and xx seconds. For printer support, see [SGD Command Support on page 1267](#).

Type `getvar`

Commands	Details
<code>getvar</code>	This command retrieves the amount of time the print has been powered on. It responds in the following format (days, hours, minutes, and seconds). <i>Format:</i> <code>! U1 getvar "device.uptime"</code>



Note • For details on SGD command structure, see [Command Structure on page 635](#).



Example • In this example, the `getvar` retrieves the amount of time the printer has been turned on.

```
! U1 getvar "device.uptime"
```

```
"00 days 02 hours 45 mins 30 secs"
```

device.user_p1

Description This command saves and retrieves user specified values. For printer support, see [SGD Command Support on page 1267](#).

Type setvar;getvar

Commands	Details
setvar	This command instructs the printer to set user parameters. <i>Format:</i> ! U1 setvar "device.user_p1" "value" <i>Values:</i> alphanumeric text string (1 - 20) <i>Default Value:</i> ""
getvar	This command saves and retrieves user specified parameters. <i>Format:</i> ! U1 getvar "device.user_p1"



Note • For details on SGD command structure, see [Command Structure on page 635](#).



Example • This `setvar` example shows the value set to "test".

```
! U1 setvar "device.user_p1" "test"
```

When the `setvar` value is set to "test", the `getvar` result is "test".

device.user_p2

Description This command saves and retrieves user specified values. For printer support, see [SGD Command Support on page 1267](#).

Type setvar;getvar

Commands	Details
setvar	This command instructs the printer to set user parameters. <i>Format:</i> ! U1 setvar "device.user_p2" "value" <i>Values:</i> alphanumeric text string (1 - 20) <i>Default:</i> ""
getvar	This command saves and retrieves user specified parameters. <i>Format:</i> ! U1 getvar "device.user_p2"



Note • For details on SGD command structure, see [Command Structure on page 635](#).



Example • This `setvar` example shows the value set to "test".

```
! U1 setvar "device.user_p2" "test"
```

When the `setvar` value is set to "test", the `getvar` result is "test".

device.user_vars.create

Description This command creates a user variable with the specified name, type, range, and default value.

The root SGD location for user variables is "device.user_vars".

Supported Devices

- iMZ 220™, iMZ 320™
- QLn220™, QLn320™, QLn420™
- ZT210™, ZT220™, ZT230™

Type setvar

Commands	Details
setvar	<p>This command instructs the printer to create a user variable with the specified parameters.</p> <p><i>Format:</i> ! U1 setvar "device.user_vars.create" "name:type:range:defaultValue"</p> <p><i>Values:</i></p> <ul style="list-style-type: none"> • name = the name of the SGD to appear in device.user_vars. The name can be anything from 1 to 64 printable ASCII characters. Any '.' within the name will be replaced with '_'. (e.g. "john.doe" will be changed to "john_doe"). The name must be unique in the device.user_vars branch or it will not be created. The name will be converted to lower case. • type = one of STRING, INTEGER, DOUBLE, CHOICES, UPDOWNCHOICES, UPDOWNINTEGER, UPDOWNDOUBLE. The type must be one of these types or the variable will not be created. <ul style="list-style-type: none"> • STRING - For strings the range indicates the min/max length of the data that can be stored. If the range is left blank, the default range is a string length of 0-1024. There is no maximum string length, however, if large data is placed into the variables the user should be aware that system memory and performance will be affected. Strings larger than available system memory will not be stored. Values should attempt to stay around, or below, 5K. • INTEGER/UPDOWNINTEGER - For integers the range can be any number expressed by a 32-bit integer, signed or unsigned. If the range is left blank then a range of -32768 to 32767 will be used. • DOUBLE/UPDOWNDOUBLE - A double can be any value within the range of +/-1.7e308. If the range is left blank then a range of -32768.0 to 32767.0 will be used. • CHOICES/UPDOWNCHOICES - Choices must be specified in a comma delimited list. The range cannot be blank if the type is CHOICES or UPDOWNCHOICES. • range = Expressed as x-y. The range of a variable depends upon the type. Some types will create default ranges, while others will fail to be created if the range is invalid or not specified. • default = the default value for the variable. The value must fall within the range specified or the variable will not be created. If the type is INTEGER, UPDOWNINTEGER, DOUBLE, UPDOWNDOUBLE the default value will be 0 if not specified. For STRING the default value will be an empty string if it is not specified. CHOICES and UPDOWNCHOICES must have a default value and it must be one of the choices within the specified range. • All four parts of the creation string must be present (some can be empty) meaning that there must be three delimiter characters (':') present. There is no error shown or indicated otherwise when the variable is not created for some reason. If the variable is not created one of the rules listed above has been violated. • Any user variables will be deleted from the device.user_vars branch on a power cycle (they won't be recreated on the next power up). • Defaulting the user_vars branch will restore the consumers back to their defaulted values and will not remove them from the user_vars branch. <p><i>Default:</i> NA</p>



Example • To create a user variable named `userVar1` that is an integer with a minimum of 1, a maximum of 10, and a default/initial value of 5, issue this command:

```
! U1 setvar "device.user_vars.create" "userVar1:INTEGER:1-10:5"
```

After issuing the above “create” command the `device.user_vars.userVar1` SGD will be present in an ALLCV response.

After issuing the above “create” command the `device.user_vars.userVar1` SGD may be set via:

```
! U1 setvar "device.user_vars.userVar1" "2"
```

After issuing the above “create” command the “`device.user_vars.userVar1`” SGD may be retrieved via:

```
! U1 getvar "device.user_vars.userVar1"
```



Note •

- For printer support, see [SGD Command Support on page 1267](#).
- For details on SGD command structure, see [Command Structure on page 635](#).

device.user_vars.set_range

Description This command compliments the `device.user_vars.create` command, allowing a user to change the range of a user-created SGD variable. It has a similar syntax to `device.user_vars.create` with the exception that no default is specified.

Supported Devices

- iMZ 220™, iMZ 320™
- QLn220™, QLn320™, QLn420™
- ZT210™, ZT220™, ZT230™

Type `getvar`

Commands	Details
<code>setvar</code>	<p>This command allows the user to change the range of a user-created variable.</p> <p><i>Format:</i> <code>! U1 setvar "device.user_vars.set_range" "name:type:range"</code></p> <p><i>Values:</i></p> <ul style="list-style-type: none"> • <code>name</code> = the name of the SGD to modify • <code>type</code> = Must be the same type for 'name' as when it was created • <code>range</code> = x-y (for all but UPDOWNCHOICES and CHOICES) or a,b,c,d (for CHOICES and UPDOWNCHOICES) • If no range is specified then it will delete whatever range is currently specified. <p><i>Default:</i> NA</p>



Example • This example modifies my_var to:

```
device.user_vars.my_var : b , Choices: a,b,c,d,e
```

```
! U1 setvar "device.user_vars.set_range" "my_var:CHOICES:a,b,c,d,e"
```



Note •

- For printer support, see [SGD Command Support on page 1267](#).
- For details on SGD command structure, see [Command Structure on page 635](#).

device.xml.enable

Description This command enables and disables language parsing support for XML. When enabled (on), the printer will parse both ZPL and XML. When disabled (off), the printer will not parse XML data. For printer support, see [SGD Command Support on page 1267](#).

Type setvar;getvar

Commands	Details
setvar	<p>This command instructs the printer to disable or enable the language parsing support for XML.</p> <p><i>Format:</i> ! U1 getvar "device.xml.enable" "value"</p> <p><i>Values:</i></p> <ul style="list-style-type: none"> "on" = enables language parsing support for XML "off" = disables language parsing support for XML <p><i>Default Value:</i> on</p>
getvar	<p>This command enables and disables language parsing support for XML.</p> <p><i>Format:</i> ! U1 getvar "device.xml.enable"</p>



Note • For details on SGD command structure, see [Command Structure on page 635](#).



Example • This `setvar` example shows the language parsing support for XML set to "on".

```
! U1 setvar "device.xml.enable" "on"
```

When the `setvar` value is set to "on", the `getvar` result is language parsing support for XML set to "on".

display.backlight

Description This parameter determines if the printer display backlight will be active. Valid only on printers with a display installed.

Supported Devices ZT200 Series

Type setvar;setvar

Commands	Details
setvar	This command instructs the printer to turn on or off the backlight display. <i>Format:</i> ! U1 setvar "display.backlight" "value" <i>Values:</i> on, off <i>Default:</i> on
getvar	This command returns if the display backlight is on or off.. <i>Format:</i> ! U1 getvar "display.backlight"



Example • This example sets the backlight display to "on".

```
! U1 setvar "display.backlight" "on"
```



Note •

- For printer support, see [SGD Command Support on page 1267](#).
- For details on SGD command structure, see [Command Structure on page 635](#).

display.backlight_on_time

Description This command sets the amount of time before the backlight turns off. Valid only on printers with a display installed.

Supported Devices ZT200 Series

Type setvar;setvar

Commands	Details
setvar	<p>This command sets the display length in seconds.</p> <p><i>Format:</i> ! U1 setvar "display.backlight_on_time" "time"</p> <p><i>Values:</i> 0-8191</p> <p><i>Default:</i> 0</p> <p> Note • If the value is set to 0, the backlight will remain on.</p>
getvar	<p>This command returns the display length in seconds.</p> <p><i>Format:</i> ! U1 getvar "display.backlight_on_time"</p>



Example • This `setvar` example shows the value set to one minute (60 seconds).

```
! U1 setvar "display.backlight_on_time" "60"
```



Note •

- For printer support, see [SGD Command Support on page 1267](#).
- For details on SGD command structure, see [Command Structure on page 635](#).

display.language

Description This command sets the display language for the control panel. This is equivalent to the ^KL ZPL command.

Supported Devices ZT200 Series

Type setvar;setvar

Commands	Details
setvar	<p>This command sets the display language for the front panel.</p> <p><i>Format:</i> ! U1 setvar "display.language" "language"</p> <p><i>Values:</i></p> <ul style="list-style-type: none"> "english" "spanish" "french" "german" "italian" "norwegian" "portuguese" "swedish" "danish" "spanish2" (<i>same as Spanish</i>) "dutch" "finnish" "japanese" "korean" "simplified chinese" "traditional chinese" "russian" "polish" "czech" "romanian" <p><i>Default:</i> "english"</p>
getvar	<p>This command returns the currently set display language.</p> <p><i>Format:</i> ! U1 getvar "display.language"</p>

a. These values are only supported on the ZT200 Series, Xi4, RXi4, ZM400/ ZM600, and RZ400/RZ600 printers.



Example • This setvar example shows the value set to "dutch".

```
! U1 setvar "display.language" "dutch"
```



Note •

- For printer support, see [SGD Command Support on page 1267](#).
- For details on SGD command structure, see [Command Structure on page 635](#).

display.load_card

Description This command loads a specific card from a WML file.

Supported Devices ZT200 Series

Type setvar

Commands	Details
setvar	<p><i>Format:</i> ! U1 setvar "display.load_card" "value"</p> <p><i>Values:</i> A valid WML filename and card within the WML filename.</p> <p> Note • The card name is case sensitive.</p>



Example •

```
! U1 setvar "display.load_card" "BLUETOOTH.WML#bluetooth2"
```



Note •

- For printer support, see [SGD Command Support on page 1267](#).
- For details on SGD command structure, see [Command Structure on page 635](#).

display.text

Description This command retrieves the text data that is being used on the printer's LCD. For printer support, see [SGD Command Support on page 1267](#).

Type `getvar`

Commands	Details
<code>getvar</code>	This command retrieves the text data that appears on the printer's LCD. <i>Format:</i> <code>! U1 getvar "display.text"</code>



Note • For details on SGD command structure, see [Command Structure on page 635](#).



Example • In this example, the `getvar` displays text content that appears on the printer's LCD.

```
! U1 getvar "display.text"
```

```
"PRINTER READY V60.16.4Z"
```

ezpl.head_close_action

Description This command sets what happens to the media after the printhead is closed and the printer is taken out of pause.

This command is similar to the ^MF ZPL command.

Supported Devices ZT200 Series

Type setvar;getvar

Commands	Details
setvar	<p>This command instructs the printer on which action to perform when the printhead is closed.</p> <p><i>Format:</i> ! U1 setvar "ezpl.head_close_action" "value"</p> <p><i>Values:</i></p> <ul style="list-style-type: none"> "feed" = feed to the first web after sensor "calibrate" = is used to force a label length measurement and adjust the media and ribbon sensor values. "length" = is used to set the label length. Depending on the size of the label, the printer feeds one or more blank labels. "no motion" = no media feed "short cal" = short calibration <p><i>Default:</i> "calibrate"</p>
getvar	<p>This command returns the currently set action to be performed when the printhead is closed.</p> <p><i>Format:</i> ! U1 getvar "ezpl.head_close_action"</p>



Example • This setvar example sets the calibration method to short calibration.

```
! U1 setvar "ezpl.head_close_action" "short cal"
```



Note •

- For printer support, see [SGD Command Support on page 1267](#).
- For details on SGD command structure, see [Command Structure on page 635](#).

ezpl.label_length_max

Description This command sets the maximum label length in inches.

This command is equivalent to the ^ML ZPL command.

Supported Devices ZT200 Series

Type setvar;getvar

Commands	Details
setvar	This command sets the maximum label length in inches. <i>Format:</i> ! U1 setvar "ezpl.label_length_max" "value" <i>Values:</i> 1.0 to 39.0 <i>Default:</i> "39"
getvar	This command retrieves the current maximum label length setting in inches. <i>Format:</i> ! U1 getvar "ezpl.label_length_max"



Example • This example sets the label length to 6.2 inches.

```
! U1 setvar ezpl.label_length_max" "6.2"  
! U1 setvar ezpl.label_length_max" "14"
```

Note • Values can be expressed to one decimal place.



Note •

- For printer support, see [SGD Command Support on page 1267](#).
- For details on SGD command structure, see [Command Structure on page 635](#).

ezpl.label_sensor

Description This command sets the paper out threshold value.

Supported Devices ZT200 Series

Type setvar;setvar

Commands	Details
setvar	This command sets the paper out threshold value. <i>Format:</i> ! U1 setvar "ezpl.label_sensor" "value" <i>Values:</i> "0" to "255", interger values only <i>Default:</i> "70"
getvar	This command retrieves the currently set paper out threshold value. <i>Format:</i> ! U1 getvar "ezpl.label_sensor"



Example • This `setvar` example shows the value set to 50.

```
! U1 setvar "ezpl.label_sensor" "50"
```



Note •

- For printer support, see [SGD Command Support on page 1267](#).
- For details on SGD command structure, see [Command Structure on page 635](#).

ezpl.manual_calibration

Description This command initiates a manual calibration sequence.

Supported Devices ZT200 Series

Type setvar;do

Commands	Details
setvar	This command instructs the printer to initiate a manual calibration. <i>Format:</i> ! U1 setvar "ezpl.manual_calibration" "" <i>Values:</i> NA <i>Default:</i> NA
do	This command instructs the printer to initiate a manual calibration. <i>Format:</i> ! U1 do "ezpl.manual_calibration" "" <i>Values:</i> NA <i>Default:</i> NA



Note •

- For printer support, see [SGD Command Support on page 1267](#).
- For details on SGD command structure, see [Command Structure on page 635](#).

ezpl.media_type

Description This command specifies the media type being used.

This command is similar to the ^MN ZPL command.

Supported Devices ZT200 Series

Type setvar;setvar

Commands	Details
setvar	<p>This command sets the media type used in the printer.</p> <p><i>Format:</i> ! U1 setvar "ezpl.media_type" "value"</p> <p><i>Values:</i></p> <ul style="list-style-type: none"> "continuous" "gap/notch" "mark" <p><i>Default:</i> "gap/notch"</p>
getvar	<p>This command returns the current media type setting.</p> <p><i>Format:</i> ! U1 getvar "ezpl.media_type"</p>



Example • This `setvar` example sets the media type to "continuous".

```
! U1 setvar "ezpl.media_type" "continuous"
```



Note •

- For printer support, see [SGD Command Support on page 1267](#).
- For details on SGD command structure, see [Command Structure on page 635](#).

ezpl.power_up_action

Description This command sets what happens to the media when the printer is powered on. This command is similar to the ^MF ZPL command.

Supported Devices ZT200 Series

Type setvar;getvar

Commands	Details
setvar	<p>This command sets the media motion and calibration setting at printer power up.</p> <p><i>Format:</i> ! U1 setvar "ezpl.power_up_action" "value"</p> <p><i>Values:</i></p> <ul style="list-style-type: none"> "calibrate" "feed" "length" "no motion" "short cal" <p><i>Default:</i></p> <p>"calibrate"</p>
getvar	<p>This command returns the current power up media motion and calibration settings.</p> <p><i>Format:</i> ! U1 getvar "ezpl.power_up_action"</p>

➔ **Example** • This `setvar` example sets the power up calibration setting to "length".

```
! U1 setvar "ezpl.power_up_action" "length"
```



Note •

- For printer support, see [SGD Command Support on page 1267](#).
- For details on SGD command structure, see [Command Structure on page 635](#).

ezpl.print_method

Description This command sets the print method.

This command is similar to ^MT.

Supported Devices ZT200 Series

Type setvar;getvar;do

Commands	Details
setvar	<p>This command sets the print method.</p> <p><i>Format:</i> ! U1 setvar "ezpl.print_method" "value"</p> <p><i>Values:</i></p> <p>"thermal trans"</p> <p>"direct thermal"</p> <p><i>Default:</i> "thermal trans"</p>
getvar	<p>This command retrieves the current print method setting.</p> <p><i>Format:</i> ! U1 getvar "ezpl.print_method"</p>



Example • This `setvar` example sets the print method to "direct thermal".

```
! U1 setvar ezpl.print_method "direct thermal"
```



Note •

- For printer support, see [SGD Command Support on page 1267](#).
- For details on SGD command structure, see [Command Structure on page 635](#).

ezpl.print_width

Description This command sets the print width of the label.

Supported Devices ZT200 Series

Type setvar;setvar

Commands	Details
setvar	This command sets the print width.. <i>Format:</i> ! U1 setvar "ezpl.print_width" "value" <i>Values:</i> any printhead width <i>Default:</i> the width of the printhead
getvar	This command retrieves the current print width setting. <i>Format:</i> ! U1 getvar "ezpl.print_width"



Example • This `setvar` example sets the print width value to 3.

```
! U1 setvar "ezpl.print_width" "3"
```



Note •

- For printer support, see [SGD Command Support on page 1267](#).
- For details on SGD command structure, see [Command Structure on page 635](#).

ezpl.reprint_mode

Description This command turns on/off the reprint mode.

Supported Devices ZT200 Series

Type setvar;setvar

Commands	Details
setvar	This command instructs the printer to turn on or off reprint mode. <i>Format:</i> ! U1 setvar "ezpl.reprint_mode" "value" <i>Values:</i> "on" "off" <i>Default:</i> "off"
getvar	This command retrieves the current setting for reprint mode. <i>Format:</i> ! U1 getvar "ezpl.reprint_mode"



Example • This `setvar` example turns reprint mode on.

```
! U1 setvar "ezpl.reprint_mode" "on"
```



Note •

- For printer support, see [SGD Command Support on page 1267](#).
- For details on SGD command structure, see [Command Structure on page 635](#).

ezpl.take_label

Description This command sets the take label position.

Supported Devices ZT200 Series

Type setvar;getvar

Commands	Details
setvar	This command sets the take label position . <i>Format:</i> ! U1 setvar "ezpl.take_label" "value" <i>Values:</i> "0" to "255" <i>Default:</i> "50"
getvar	This command retrieves the take label position. <i>Format:</i> getvar "ezpl.take_label"



Example • This example sets the take label position to 175.

```
! U1 setvar "ezpl.take_label" "175"
```



Note •

- For printer support, see [SGD Command Support on page 1267](#).
- For details on SGD command structure, see [Command Structure on page 635](#).

ezpl.tear_off

Description This command retrieves the tear-off position.

Supported Devices ZT200 Series

Type setvar;setvar

Commands	Details
setvar	This command sets the tear-off position. <i>Format:</i> ! U1 setvar "ezpl.tear_off" "value" <i>Values:</i> "-120" to "120" <i>Default:</i> "0"
getvar	This command retrieves the currently set tear-off position. <i>Format:</i> ! U1 getvar "ezpl.tear_off"



Example • This `setvar` example sets the tear-off value to 110.

```
! U1 setvar "ezpl.tear_off" "110"
```



Note •

- For printer support, see [SGD Command Support on page 1267](#).
- For details on SGD command structure, see [Command Structure on page 635](#).

file.delete

Description This command instructs the printer to delete specified files. For printer support, see [SGD Command Support on page 1267](#).

Type do

Commands	Details
do	<p>This command instructs the printer to delete specified files.</p> <p><i>Format:</i> ! U1 do "file.delete" "value"</p> <p><i>Values:</i> file name</p> <p> Important • Be sure to always specify the memory location.</p>



Note • For details on SGD command structure, see [Command Structure on page 914](#).





Example • This do example shows the specified file to delete.

```
! U1 do "file.delete" "e:abcd.zpl"
```

file.dir

Description This command displays a directory listing on the same port the command was received. For printer support, see [SGD Command Support on page 1267](#).

Type setvar;setvar;do

Commands	Details
setvar	<p>This command sets the directory name from which to retrieve files.</p> <p><i>Format:</i> ! U1 setvar "file.dir" "value"</p> <p><i>Values:</i> directory letter</p> <p> Important • Be sure to always specify the memory location.</p>
getvar	<p>This command retrieves a directory listing of the specified directory.</p> <p><i>Format:</i> ! U1 getvar "file.dir"</p> <p> Important • Be sure to always specify the memory location.</p>
do	<p>This command sets the directory name from which to retrieve files.</p> <p><i>Format:</i> ! U1 do "file.dir" "value"</p> <p><i>Values:</i> directory letter</p> <p> Important • Be sure to always specify the memory location.</p>



Note • For details on SGD command structure, see [Command Structure on page 914](#).



Example • This do example shows the directory listing of the specified directory.

```
! U1 do "file.dir" "R:"
- DIR R:*. *
- 11172192 bytes free R: RAM
```

file.dir_format

Description This command controls the output format of the `file.dir` Set/Get/Do command.

Supported Devices ZT200 Series

Type setvar;getvar;do

Commands	Details
setvar	This command sets the output format. <i>Format:</i> ! U1 setvar "file.dir_format" "value" <i>Values:</i> "cpcl" "zpl"
getvar	This command retrieves the current setting for the output format. <i>Format:</i> ! U1 getvar "file.dir_format" <i>Result:</i> "cpcl" "zpl"
do	This command sets the output format. <i>Format:</i> ! U1 do "file.dir_format" "value" <i>Values:</i> "cpcl" "zpl"



Example • This `do` example sets the directory format to CPCL.

```
! U1 do "file.dir_format" "cpcl"
```





Note •

- For printer support, see [SGD Command Support](#) on page 1267.
- For details on SGD command structure, see [Command Structure](#) on page 635.

file.type

Description This command displays the contents of the specified file. For printer support, see [SGD Command Support on page 1267](#).

Type setvar; do

Commands	Details
setvar	<p>This command instructs the printer to display the content of a file on the same port the command was received.</p> <p><i>Format:</i> ! U1 setvar "file.type" "value"</p> <p><i>Values:</i> the drive letter, file name, file extension, such as R:TEST.ZPL</p> <p> Important • Be sure to always specify the memory location.</p>
do	<p>This command displays the content of a file on the same port the command was received.</p> <p><i>Format:</i> ! U1 do "file.type" "value"</p> <p><i>Values:</i> the drive letter, file name, file extension, such as R:TEST.ZPL</p> <p> Important • Be sure to always specify the memory location.</p>



Note • For details on SGD command structure, see [Command Structure on page 635](#).



Example • This setvar example shows the value set to "R:TEST.ZPL".



```
! U1 setvar "file.type" "R:TEST.ZPL"
```

When the setvar value is set to "R:TEST.ZPL", the contents of the file TEST.ZPL located on the R: drive will be displayed.

file.run

Description This command instructs the printer to send a specified file to the parser. For printer support, see *SGD Command Support on page 1267*.

Type setvar; do

Commands	Details
setvar	<p>This command instructs the printer to send a specified file to the parser.</p> <p><i>Format:</i> ! U1 setvar "file.run" "values"</p> <p><i>Values:</i> drive:filename.extension</p> <p> Important • Be sure to always specify the memory location.</p>
do	<p>This command instructs the printer to send a specified file to the parser.</p> <p><i>Format:</i> ! U1 do "file.run" "value"</p> <p><i>Values:</i> drive:filename.extension</p> <p> Important • Be sure to always specify the memory location.</p>



Note • For details on SGD command structure, see *Command Structure on page 635*.



Example • This setvar example will send the file "text.zpl" stored in RAM to the parser.

```
! U1 setvar "file.run" "R:text.zpl"
```

formats.cancel_all

Description The ~JA command cancels all format commands in the buffer. It also cancels any batches that are printing.

This command is equivalent to the ~JA ZPL command.

Supported Devices ZT200 Series

Type setvar;do

Commands	Details
setvar	This command cancels all format commands in the buffer. <i>Format:</i> ! U1 setvar "formats.cancel_all" "" <i>Values:</i> NA <i>Default:</i> NA
do	This command cancels all format commands in the buffer. <i>Format:</i> ! U1 do "formats.cancel_all" ""



Note •

- For printer support, see [SGD Command Support on page 1267](#).
- For details on SGD command structure, see [Command Structure on page 635](#).

head.latch

Description This command identifies if the printhead is open or closed. For printer support, see [SGD Command Support on page 1267](#).

Type getvar

Commands	Details
getvar	<p>This command retrieves the status of the printhead, open or closed.</p> <p><i>Format:</i> ! U1 getvar "head.latch"</p> <p><i>Values:</i></p> <ul style="list-style-type: none">"ok" = closed"open" = open



Note • For details on SGD command structure, see [Command Structure on page 635](#).



Example • In this example, the `getvar` retrieves the status of the print head.

```
! U1 getvar "head.latch"
```

```
"ok"
```

input.capture

Description This parameter allows capturing input data in diagnostics mode. Input capture has three modes: "print", "run", and "off". The "print" and "run" modes can be used to examine data received by the printer.

When in "print" mode the printer will save incoming data to files named "in???.dmp", where ??? is a number between 001 to 999. The printer will then print the text and hexadecimal representation of data bytes received instead of printing the formatted labels which that data might represent. When in "run" mode the printer will save captured incoming data to files as above, but will otherwise run the incoming data/commands normally.

The capture files should be deleted from printer memory after retrieving them. Leaving the printer in "print" or "run" mode and not deleting the capture files will reduce the printer's available flash memory.

The "off" mode is the printer's normal operating mode. Cycling power will also return the printer to "off" mode.



Note • This command does not capture a network packet trace.

Supported Devices ZT200 Series

Type setvar;getvar;do

Commands	Details
setvar	This command sets the directory name from which to retrieve files. <i>Format:</i> ! U1 setvar "input.capture" "value" <i>Values:</i> "print" "run" "off" <i>Default:</i> "off"
getvar	This command retrieves the current input.capture setting value. <i>Format:</i> ! U1 getvar "input.capture"



Note •

- For printer support, see [SGD Command Support](#) on page 1267.
- For details on SGD command structure, see [Command Structure](#) on page 635.

interface.network.active.arp_interval

Description This command changes the arp interval.

Supported Devices ZT200 Series

Type setvar;setvar

Commands	Details
setvar	This command retrieves the gateway address of the active print server. <i>Format:</i> ! U1 getvar "interface.network.active.arp_interval" "value" <i>Values:</i> integer values from "0" to "30" <i>Default Value:</i> "0"
getvar	This command retrieves the current arp interval setting, shown in minutes. <i>Format:</i> ! U1 getvar "interface.network.active.arp_interval"



Example • In this example, the `setvar` changes the arp interval to three minutes.

```
! U1 getvar "interface.network.active.arp_interval" "3"
```



Note •

- For printer support, see [SGD Command Support on page 1267](#).
- For details on SGD command structure, see [Command Structure on page 635](#).

interface.network.active.cable_type

Description This command returns the cable type of the active network, either 10/100BaseT, Wireless 802.11b/g, or Wireless 802.11n.



Note • This command will only give a valid response once an IP address has been established.

Supported Devices ZT200 Series

Type getvar

Commands	Details
getvar	<p>This command retrieves the current cable type of the active network.</p> <p><i>Format:</i> ! U1 getvar "interface.network.active.cable_type"</p> <p><i>Values:</i></p> <p>"10/100BaseT"</p> <p>"Wireless 802.11b/g"</p> <p>"Wireless 802.11n"</p> <p><i>Default:</i> NA</p>



Note •

- For printer support, see [SGD Command Support on page 1267](#).
- For details on SGD command structure, see [Command Structure on page 635](#).

interface.network.active.dhcp_received_host_name

Description This command reports the Host Name as assigned by the DHCP Server. If one is not assigned, or DHCP is not used, then the field will be blank.



Note • This command will only give a valid response once an IP address has been established.

Supported Devices ZT200 Series

Type getvar

Commands	Details
getvar	This command reports the host name.. <i>Format:</i> ! U1 getvar "interface.network.active.dhcp_received_host_name"



Example •

```
! U1 getvar "interface.network.active.dhcp_received_host_name"  
Result:  
"Zebra Printer on shelf 2112"
```



Note •

- For printer support, see [SGD Command Support on page 1267](#).
- For details on SGD command structure, see [Command Structure on page 635](#).

interface.network.active.gateway

Description This command retrieves the gateway address of the active print server. For printer support, see *SGD Command Support on page 1267*.

Type `getvar`

Commands	Details
<code>getvar</code>	This command retrieves the gateway address of the active print server. <i>Format:</i> <code>! U1 getvar "interface.network.active.gateway"</code>



Note • For details on SGD command structure, see *Command Structure on page 635*.



Example • In this example, the `getvar` retrieves the gateway address of the active print server.

```
! U1 getvar "interface.network.active.gateway"

"10.3.5.1"
```

interface.network.active.ip_addr

Description This command retrieves the IP address of the active print server. For printer support, see *SGD Command Support on page 1267*.

Type `getvar`

Commands	Details
<code>getvar</code>	This command retrieves the IP address of the active print server. <i>Format:</i> ! U1 <code>getvar "interface.network.active.ip_addr"</code>



Note • For details on SGD command structure, see *Command Structure on page 635*.



Example • In this example, the `getvar` retrieves the IP address of the active print server.

```
! U1 getvar "interface.network.active.ip_addr"  
  
"10.3.5.92"
```

interface.network.active.mac_addr

Description This command retrieves the MAC address of the active print server. For printer support, see *SGD Command Support* on page 1267.

Type `getvar`

Commands	Details
<code>getvar</code>	<p>This command retrieves the MAC address of the active print server.</p> <p><i>Format:</i></p> <pre>! U1 getvar "interface.network.active.mac_addr"</pre>



Note • For details on SGD command structure, see *Command Structure* on page 635.



Example • In this example, the `getvar` retrieves the MAC address of the active print server.

```
! U1 getvar "interface.network.active.mac_addr"
```

```
"00:07:4d:24:08:ff"
```

interface.network.active.mac_raw

Description This command identifies the RAW MAC address of the active print server. The raw mac address is the mac address without the colons (":"). For printer support, see [SGD Command Support on page 1267](#).

Type getvar

Commands	Details
getvar	This command retrieves the RAW MAC address of the active print server. <i>Format:</i> ! U1 getvar "interface.network.active.mac_raw"



Note • For details on SGD command structure, see [Command Structure on page 635](#).



Example • In this example, the `getvar` retrieves the RAW MAC address of the active print server.

```
! U1 getvar "interface.network.active.mac_raw"  
  
"00074d2408ff"
```

interface.network.active.netmask

Description This command retrieves the netmask of the active print server. For printer support, see *SGD Command Support on page 1267*.

Type `getvar`

Commands	Details
<code>getvar</code>	<p>This command retrieves the netmask of the active print server.</p> <p><i>Format:</i></p> <pre>! U1 getvar "interface.network.active.netmask"</pre>



Note • For details on SGD command structure, see *Command Structure on page 635*.



Example • In this example, the `getvar` retrieves the netmask of the active print server.

```
! U1 getvar "interface.network.active.netmask"
```

```
"255.255.255.0"
```

interface.network.active.protocol

Description This command retrieves IP protocol of the active print server. For printer support, see [SGD Command Support on page 1267](#).

Type getvar

Commands	Details
getvar	This command retrieves the IP protocol of the active print server. <i>Format:</i> ! U1 getvar "interface.network.active.protocol"



Note • For details on SGD command structure, see [Command Structure on page 635](#).

interface.network.active.protocol_error

Description This command returns the last error reported by the active print server.

Supported Devices ZT200 Series

Type getvar

Commands	Details
getvar	This command returns the last error reported by the active print server. <i>Format:</i> ! U1 getvar "interface.network.active.protocol_error"



Note •

- For printer support, see [SGD Command Support on page 1267](#).
- For details on SGD command structure, see [Command Structure on page 635](#).

interface.network.active.rx_errors

Description This command returns the current number of packet receive errors on the active network interface.

Supported Devices ZT200 Series

Type `getvar`

Commands	Details
<code>getvar</code>	This command returns the current number of packet receive errors. <i>Format:</i> ! U1 <code>getvar "interface.network.active.rx_errors"</code> <i>Result:</i> The current number of errors.



Note •

- For printer support, see [SGD Command Support on page 1267](#).
- For details on SGD command structure, see [Command Structure on page 635](#).

interface.network.active.rx_packets

Description This command returns the number of packets received on the active network interface since the last power cycle.

Supported Devices ZT200 Series

Type `getvar`

Commands	Details
<code>getvar</code>	<p>This command returns the number of packets received on the active network interface since the last power cycle.</p> <p><i>Format:</i> ! U1 <code>getvar "interface.network.active.rx_packets"</code></p> <p><i>Result:</i> An integer.</p>



Note •

- For printer support, see [SGD Command Support on page 1267](#).
- For details on SGD command structure, see [Command Structure on page 635](#).

interface.network.active.server_address

Description This command returns the network IP address of the server that provided the printer's IP address.

Supported Devices ZT200 Series

Type `getvar`

Commands	Details
<code>getvar</code>	This command returns the network IP address of the server providing the printer's IP address. <i>Format:</i> ! U1 <code>getvar "interface.network.server_address"</code> <i>Result:</i> an IP address



Note •

- For printer support, see [SGD Command Support on page 1267](#).
- For details on SGD command structure, see [Command Structure on page 635](#).

interface.network.active.protocol_error

Description This command returns the last error reported by the print server.

Supported Devices ZT200 Series

Type getvar

Commands	Details
getvar	<p>This command returns the last error reported by the print server.</p> <p><i>Format:</i> ! U1 getvar "interface.network.active.protocol_error"</p> <p><i>Result:</i> WINS Name in Conflict</p>



Note •

- For printer support, see [SGD Command Support on page 1267](#).
- For details on SGD command structure, see [Command Structure on page 635](#).

interface.network.active.speed

Description This command returns the speed in megabits per second of the active print server network since the last power cycle.

Supported Devices ZT200 Series

Type `getvar`

Commands	Details
<code>getvar</code>	This command returns the active print server network speed since the last power cycle. <i>Format:</i> ! U1 <code>getvar "interface.network.active.speed"</code> <i>Result:</i> A number indicating megabits/second



Note •

- For printer support, see [SGD Command Support on page 1267](#).
- For details on SGD command structure, see [Command Structure on page 635](#).

interface.network.active.tx_errors

Description This command returns the number of packet transmit errors on the active print server network since the last power cycle.

Supported Devices ZT200 Series

Type `getvar`

Commands	Details
<code>getvar</code>	<p>This command returns the number of packet transmit errors on the active print server network since the last power cycle.</p> <p><i>Format:</i> ! U1 <code>getvar "interface.network.active.tx_errors"</code></p> <p><i>Result:</i> An integer number</p>



Note •

- For printer support, see [SGD Command Support on page 1267](#).
- For details on SGD command structure, see [Command Structure on page 635](#).

interface.network.active.tx_packets

Description This command returns the number of packets transmitted on the active print server network since the last power cycle.

Supported Devices ZT200 Series

Type `getvar`

Commands	Details
<code>getvar</code>	<p>This command returns the number of packets transmitted on the active print server network since the last power cycle.</p> <p><i>Format:</i> ! U1 <code>getvar "interface.network.active.tx_packets"</code></p> <p><i>Result:</i> A number.</p>



Note •

- For printer support, see [SGD Command Support on page 1267](#).
- For details on SGD command structure, see [Command Structure on page 635](#).

interface.network.active.wins_addr

Description This command sets and retrieves the active WINS address.

Supported Devices ZT200 Series

Type setvar;getvar

Commands	Details
setvar	This command sets the WINS address of the active print server. <i>Format:</i> ! U1 setvar "interface.network.active.wins_addr" "value" <i>Values:</i> "0.0.0.0" - "255.255.255.255"
getvar	This command retrieves the WINS address of the active print server. <i>Format:</i> ! U1 getvar "interface.network.active.wins_addr" <i>Result:</i> a WINS address



Example • In this example, the `setvar` sets the Wins address of the active print server.

```
! U1 setvar "interface.network.active.wins_addr" "10.3.5.120"
```



Note •

- For printer support, see [SGD Command Support on page 1267](#).
- For details on SGD command structure, see [Command Structure on page 635](#).

media.cartridge.part_number

Description This printer command retrieves the part number of the media cartridge used in the printer.

Supported Devices

- HC100

Type getvar

Commands	Details
getvar	This command instructs the printer to respond with the media cartridge part number currently being used by the printer. <i>Format: ! U1 getvar "media.cartridge.part_number"</i>



Note • For details on SGD command structure, see [Command Structure on page 635](#).



Example • In this example, the getvar returns the part number of the media cartridge.

```
! U1 getvar "media.cartridge.part_number" "10006999"
```

media.cut_now

Description This command instructs the printer cycle the media cutter. If the printer is in Print Mode Kiosk (media.printmode “K”) then the cutter will execute a cut based on the value of media.present.cut_amount – either a normal cut or a partial cut. If the printer is not in Print Mode Kiosk (media.printmode “K”), this command does nothing. See [media.present.cut_amount on page 796](#).

Supported Devices

- KR403

Type setvar; do

Commands	Details
setvar	<p>This command instructs the printer to cycle the media cutter.</p> <p><i>Format: ! U1 setvar "media.cut_now" ""</i></p> <p> Note • See media.present.cut_amount on page 796.</p>
do	<p>This command instructs the printer to cycle the media cutter.</p> <p><i>Format: ! U1 do "media.cut_now" ""</i></p>



Note • For details on SGD command structure, see [Command Structure on page 635](#).

media.darkness_mode

Description This command instructs the printer to set the darkness mode. For printer support, see [SGD Command Support on page 1267](#).

Type setvar

Commands	Details
setvar	<p>This command instructs the printer to set the darkness mode.</p> <p><i>Format:</i></p> <pre>! U1 setvar "media.darkness_mode" "value"</pre> <p><i>Values:</i></p> <ul style="list-style-type: none">"cartridge" = cartridge mode (no changes allowed)"user" = user mode (Darkness is set by the user, and the cartridge value is ignored. This value is used for all cartridges inserted in the printer)."relative" = relative mode (the specified darkness value is added to the cartridge default value) <p><i>Default Value:</i> "cartridge"</p>



Note • For details on SGD command structure, see [Command Structure on page 635](#).



Example • This setvar example shows the darkness mode set to "cartridge".

```
! U1 setvar "media.darkness_mode" "cartridge"
```

media.draft_mode

Description This command puts the printer into draft mode setting.



Note • Setting the printer to draft mode may result in poorer print quality depending on print speed, label configurations, etc.

Supported Devices ZE500-4

Type setvar, getvar

Commands	Details
setvar	<p>This command sets the value.</p> <p><i>Format:</i> ! U1 setvar "media.draft_mode" "value"</p> <p><i>Values:</i></p> <ul style="list-style-type: none"> enabled = faster ramp (acceleration) speed disabled = normal ramp (acceleration) speed <p><i>Default:</i> disabled</p>
getvar	<p>This command instructs the printer to respond with the currently set value.</p> <p><i>Format:</i> ! U1 getvar "media.draft_mode"</p>



Note •

- For printer support, see [SGD Command Support on page 1267](#).
- For details on SGD command structure, see [Command Structure on page 635](#).

media.media_low.external

Description This printer setting gets the status of the external media_low warning. For printer support, see [SGD Command Support on page 1267](#).

Supported Devices

- KR403

Type `getvar`

Commands	Details
<code>getvar</code>	<p>This command instructs the printer to respond with the currently set media print mode.</p> <p><i>Format:</i></p> <pre>! U1 getvar "media.media_low.external"</pre> <p><i>Values:</i></p> <ul style="list-style-type: none">0 = Paper present at sensor position1 = No paper present <p> Note • The status of the sensor is sampled every time the printout is cut. If three succeeding samples show "no paper", the status reply changes to 1. This is to prevent a false alarm if the side of the paper roll is not clean. If the current status of the sensor is required, use <code>~HQES</code> and extract the paper near-end sensor bit.</p>



Note • For details on SGD command structure, see [Command Structure on page 635](#).

media.media_low.warning

Description This command retrieves the value of, or enables or disables the Supplies Warning system. For printer support, see *SGD Command Support* on page 1267.

Supported Devices

- Xi4
- RXi4

Type setvar;getvar

Commands	Details
setvar	This command enables or disables the Supplies Warning System. <i>Format:</i> ! U1 setvar "media.media_low.warning" "value" <i>Values:</i> "disabled" = not active "enabled" = active <i>Default:</i> "disabled"
getvar	This command retrieves the setting for the Supplies Warning system. <i>Format:</i> ! U1 getvar "media.media_low.warning"



Note • For details on SGD command structure, see *Command Structure* on page 635.



Example 1 • This `setvar` example disables the Supplies Warning system.

```
! U1 setvar "media.media_low.warning" "disabled"
```



Example 2 • This `setvar` example enables the Supplies Warning system.

```
! U1 setvar "media.media_low.warning" "enabled"
```

media.present.cut_amount

Description This printer setting determines the type of cut made by the printer cutter (normal or partial) and, if partial, the length of the partial cut on each side, in mm. For printer support, see [SGD Command Support on page 1267](#).

Supported Devices

- KR403

Type setvar;getvar

Commands	Details
setvar	<p>This command instructs the printer to change the media cut amount.</p> <p><i>Format:</i></p> <pre>! U1 setvar "media.present.cut_amount" "value"</pre> <p><i>Values:</i></p> <p>0 = normal cut</p> <p>10-60 = partial cut, value = mm of media left uncut</p>
getvar	<p>This command instructs the printer to respond with the currently set media cut amount.</p> <p><i>Format:</i></p> <pre>! U1 getvar "media.present.cut_amount"</pre>



Note • For details on SGD command structure, see [Command Structure on page 635](#).

media.present.eject

Description This command instructs the printer to eject the document through the presenter module. The value is the amount to eject, in mm. The value of [media.present.length_addition](#) gets added to the value to determine the total length of media ejected. For printer support, see [SGD Command Support on page 1267](#).

Supported Devices

- KR403

Type setvar; do

Commands	Details
setvar	<p>This command instructs the printer to eject the document through the presenter module.</p> <p><i>Format:</i> ! U1 setvar "media.present.eject" "value"</p> <p><i>Values:</i></p> <p>0 - 255 = amount of media to eject in mm</p> <p> Note • See media.present.length_addition on page 798.</p>
do	<p>This command instructs the printer to eject the document through the presenter module.</p> <p><i>Format:</i> ! U1 do "media.present.eject" "value"</p>



Note • For details on SGD command structure, see [Command Structure on page 635](#).

media.present.length_addition

Description This printer setting adds an additional amount to how far the paper is ejected during a present cycle. A standard amount of 50mm is always added to clear the kiosk wall. This amount is added to that 50mm. The total amount of media ejected this command is executed, then, is 50mm + media.present.length_addition + media.present.eject. For printer support, see [SGD Command Support on page 1267](#).

Supported Devices

- KR403

Type setvar;getvar

Commands	Details
setvar	This command instructs the printer to change the media present length addition. <i>Format:</i> ! U1 setvar "media.present.length_addition" "value" <i>Values:</i> 0-255 = additional mm of media to eject
getvar	This command instructs the printer to respond with the currently set media present length addition. <i>Format:</i> ! U1 getvar "media.present.length_addition"



Note • For details on SGD command structure, see [Command Structure on page 635](#).

media.present.loop_length

Description This printer setting determines the length of the presenter loop. If loop_length is greater than loop_length_max (see media.present.loop_length_max) then it will be set equal to loop_length_max. For printer support, see [SGD Command Support on page 1267](#).

Supported Devices

- KR403

Type setvar;getvar

Commands	Details
setvar	<p>This command instructs the printer to change the presenter loop length.</p> <p><i>Format:</i></p> <pre>! U1 setvar "media.present.loop_length" "value"</pre> <p><i>Values:</i></p> <p>0 = paper is fed straight through the presenter</p> <p>3-1023 = loop length in mm.</p> <p><i>Default:</i></p> <p>400 = gives a loop of approximately 400mm</p>
getvar	<p>This command instructs the printer to respond with the currently set presenter loop length.</p> <p><i>Format:</i> ! U1 getvar "media.present.loop_length"</p>



Note • For details on SGD command structure, see [Command Structure on page 635](#).

media.present.loop_length_max

Description This printer setting determines the maximum allowed length of the presenter loop. For printer support, see [SGD Command Support on page 1267](#).

Supported Devices

- KR403

Type setvar;getvar

Commands	Details
setvar	<p>This command instructs the printer to change the presenter loop length.</p> <p><i>Format:</i></p> <pre>! U1 setvar "media.present.loop_length_max" "value"</pre> <p><i>Values:</i></p> <ul style="list-style-type: none">0 = paper is fed straight through the presenter3-1023 = loop length in mm. <p><i>Default:</i></p> <ul style="list-style-type: none">400 = gives a loop of approximately 400mm
getvar	<p>This command instructs the printer to respond with the currently set presenter loop length.</p> <p><i>Format:</i></p> <pre>! U1 getvar "media.present.loop_length_max"</pre>



Note • For details on SGD command structure, see [Command Structure on page 635](#).

media.present.cut_margin

Description This printer setting determines the margin between the cutter and the printhead. For printer support, see [SGD Command Support on page 1267](#).

Supported Devices

- KR403

Type setvar;getvar

Commands	Details
setvar	This command instructs the printer to change the media cut amount. <i>Format:</i> ! U1 setvar "media.present.cut_margin" "value" <i>Values:</i> 2 - 9 = mm of distance <i>Default:</i> 9 = mm of distance
getvar	This command instructs the printer to respond with the currently set media cut margin amount. <i>Format:</i> ! U1 getvar "media.present.cut_margin"



Note • For details on SGD command structure, see [Command Structure on page 635](#).

media.present.present_timeout

Description This printer setting determines how long the printer will wait after a present event to clear the label. See ^KV ZPL command. For printer support, see [SGD Command Support on page 1267](#).

Supported Devices

- KR403

Type setvar;getvar

Commands	Details
setvar	This command instructs the printer to change the presenter function mode. <i>Format:</i> ! U1 setvar "media.present.present_timeout" "value" <i>Values:</i> 0 - 300 = If label is not taken, retract label when timeout expires. Timeout is in seconds. Zero (0) indicates that there is no timeout. The label will stay presented until removed manually or a new label is printed.
getvar	This command instructs the printer to respond with the currently set presenter function mode. <i>Format:</i> ! U1 getvar "media.present.present_timeout"



Note • For details on SGD command structure, see [Command Structure on page 635](#).

media.present.present_type

Description This printer setting determines the way that the printer performs a present command. See ^KV ZPL command. For printer support, see [SGD Command Support on page 1267](#).

Supported Devices

- KR403

Type setvar;getvar

Commands	Details
setvar	<p>This command instructs the printer to change the presenter function mode.</p> <p><i>Format:</i> ! U1 setvar "media.present.present_type" "value"</p> <p><i>Values:</i></p> <ul style="list-style-type: none"> 0 = Eject page when new page is printed 1 = Retract page when new page is printed 2 = Do nothing when new page is printed
getvar	<p>This command instructs the printer to respond with the currently set presenter function mode.</p> <p><i>Format:</i> ! U1 getvar "media.present.present_type"</p>



Note • For details on SGD command structure, see [Command Structure on page 635](#).

media.printmode

Description This printer setting determines the action the printer takes after a label or group of labels has printed. For printer support, see [SGD Command Support on page 1267](#). This command is equivalent to [^MM on page 303](#).

Type setvar;setvar

Commands	Details
setvar	<p>This command instructs the printer to change the media print mode.</p> <p><i>Format:</i> ! U1 setvar "media.printmode" "value"</p> <p><i>Values:</i></p> <ul style="list-style-type: none"> "T" = Tear-off ^a "P" = Peel-off (not available on S-300) ^{a, b} "R" = Rewind (depends on printer model) "A" = Applicator (depends on printer model) ^a "C" = Cutter (depends on printer model) ^b "D" = Delayed cutter ^{a, b} "F" = RFID ^{a, b} "L" = Linerless Peel ^{b, c} "U" = Linerless Rewind ^{b, c} "K" = Kiosk ^d "V" = Linerless Tear ^b "S" = Stream ^b
getvar	<p>This command instructs the printer to respond with the the currently set media print mode.</p> <p><i>Format:</i> ! U1 getvar "media.printmode"</p>

- a. This value is not supported on the KR403 printer.
- b. This value is not supported on the ZE500 printer.
- c. This value is supported only on the ZM400/ZM600 and RZ400/RZ600 printers.
- d. This value is supported only on the KR403 printer.
- e. This value is supported only on the ZE500 printer.



Note • For details on SGD command structure, see [Command Structure on page 635](#).



Example • This setvar example shows the value set to "T".

```
! U1 setvar "media.printmode" "T"
```

What the setvar value is set to is the getvar result. In this example, the getvar result is "tear off".

For more details on how each setvar value relates to the getvar responses, see [Table 25, Setvar / Getvar Relation on page 805](#).

Table 25 • Setvar / Getvar Relation

If the setvar is set to ...	Then the getvar response and control panel display is ...
"T"	TEAR OFF
"P"	PEEL OFF
"R"	REWIND
"A"	APPLICATOR
"C"	CUTTER
"D"	DELAYED CUT
"L"	RESERVED
"U"	RESERVED
"K"	KIOSK

media.speed

Description This command specifies media print speed in inches per second (ips). For printer support, see *SGD Command Support on page 1267*.

Type setvar;setvar

Commands	Details
setvar	<p>This command instructs the printer to set the media print speed.</p> <p><i>Format:</i> ! U1 setvar "media.speed" "value"</p> <p><i>Values:</i></p> <ul style="list-style-type: none"> 2-12 ips "up" = increments the printer speed by one unit "down" = decrements the speed by one unit <p><i>Default:</i> "2"</p>
getvar	<p>This command retrieves the currently set media print speed.</p> <p><i>Format:</i> ! U1 getvar "media.speed"</p>



Note • For details on SGD command structure, see *Command Structure on page 635*.



Example 1 • This `setvar` example shows the value set to "2".

```
! U1 setvar "media.speed" "2"
```

When the `setvar` value is set to "2", the `getvar` result is "2".



Example 2 • This `setvar` example shows the value set to "up".

```
! U1 setvar "media.speed" "up"
```

If the current print speed is 2: When the `setvar` value is set to "up", the `getvar` result is "3".



Example 3 • This `setvar` example shows the value set to "down".

```
! U1 setvar "media.speed" "down"
```

If the current print speed is 2: When the `setvar` value is set to "down", the `getvar` result is "1".

memory.flash_free

Description This parameter returns the amount of available Flash memory. For printer support, see [SGD Command Support on page 1267](#).

Type getvar

Commands	Details
getvar	<i>Format:</i> ! U1 getvar "memory.flash_free"



Note • For details on SGD command structure, see [Command Structure on page 635](#).

memory.flash_size

Description This parameter returns the total amount of Flash memory. For printer support, see [SGD Command Support on page 1267](#).

Type getvar

Commands	Details
getvar	<i>Format:</i> ! U1 getvar "memory.flash_size"



Note • For details on SGD command structure, see [Command Structure on page 635](#).

memory.ram_free

Description This parameter returns the amount available Random Access Memory (RAM). For printer support, see [SGD Command Support on page 1267](#).

Type `getvar`

Commands	Details
<code>getvar</code>	<i>Format:</i> ! U1 <code>getvar "memory.ram_free"</code>



Note • For details on SGD command structure, see [Command Structure on page 635](#).

memory.ram_size

Description This parameter returns the total amount of Random Access Memory (RAM).

Type `getvar`

Commands	Details
<code>getvar</code>	<i>Format:</i> ! U1 <code>getvar "memory.ram_size"</code>



Note •

- For printer support, see [SGD Command Support on page 1267](#).
- For details on SGD command structure, see [Command Structure on page 635](#).

netmanage.avalanche.agent_addr

Description This parameter obtains or changes the Network Management agent IP address.

Supported Devices ZT200 Series

Type setvar;setvar

Commands	Details
setvar	This command sets the Network Management Agent IP address . <i>Format:</i> ! U1 setvar "netmanage.avalanche.agent_addr" "value" <i>Values:</i> any valid IP address <i>Default:</i> "0.0.0.0"
getvar	This command retrieves the current Network Management IP address. <i>Format:</i> ! U1 getvar "netmanage.avalanche.agent_addr"



Example •

```
! U1 setvar "netmanage.avalanche.agent_addr" "10.14.2.200"
```



Note •

- For printer support, see [SGD Command Support on page 1267](#).
- For details on SGD command structure, see [Command Structure on page 635](#).

netmanage.avalanche.available_agent

Description This command returns the current IP address of the remote agent found during the Agent Discovery Phase.

Supported Devices ZT200 Series

Type getvar

Commands	Details
getvar	This command obtains the IP address of the remote agent found during the Agent Discovery Phase. <i>Format:</i> ! U1 getvar "netmanage.avalanche.available_agent" <i>Result:</i> An IP address



Example •

```
! U1 getvar "netmanage.avalanche.available_agent"  
Result:  
"10.3.4.128"
```



Note •

- For printer support, see [SGD Command Support on page 1267](#).
- For details on SGD command structure, see [Command Structure on page 635](#).

netmanage.avalanche.available_port

Description This command returns the available port of the remote agent found during the Agent Discovery Phase.

Supported Devices ZT200 Series

Type setvar;getvar

Commands	Details
setvar	<p>This command sets the available port of the remote agent found during the Agent Discovery Phase.</p> <p><i>Format:</i> ! U1 setvar "netmanage.avalanche.available_port" "value"</p> <p><i>Values:</i> "0" to "65535"</p> <p><i>Default:</i> "0"</p>
getvar	<p>This command retrieves the current port setting of the remote agent found during the Agent Discovery Phase.</p> <p><i>Format:</i> ! U1 getvar "netmanage.avalanche.available_port"</p>



Example •

```
U1 setvar "netmanage.avalanche.available_port" "1800"
```



Note •

- For printer support, see [SGD Command Support on page 1267](#).
- For details on SGD command structure, see [Command Structure on page 635](#).

netmanage.avalanche.encryption_type

Description This parameter sets and gets the Network Management Encryption type to be used.

Supported Devices ZT200 Series

Type setvar;getvar

Commands	Details
setvar	This command sets the Network Management Encryption type to be used. <i>Format:</i> ! U1 setvar "netmanage.avalanche.encryption_type" "value" <i>Values:</i> "0" = None "1" = Limburger "2" = AES128S <i>Default:</i> "0"
getvar	This command retrieves the currently set Network Management Encryption type. <i>Format:</i> ! U1 getvar "netmanage.avalanche.encryption_type"



Example • This example sets the value to Limburger (1) encryption type.

```
! U1 getvar "netmanage.avalanche.encryption_type" "1"
```



Note •

- For printer support, see [SGD Command Support on page 1267](#).
- For details on SGD command structure, see [Command Structure on page 635](#).

netmanage.avalanche.interval

Description This parameter obtains or sets the Network Management Update Interval time stored in the printer. Time is measured in milliseconds (e.g., a setting of "2000" equals 2 seconds).

Supported Devices ZT200 Series

Type setvar;getvar

Commands	Details
setvar	This command sets the Network Management Update Interval. <i>Format:</i> ! U1 setvar "netmanage.avalanche.interval" "value" <i>Values:</i> any integer value from "0" to "4294967295" (4,294,967,295 milliseconds) <i>Default:</i> "0"
getvar	This command retrieves the current Network Management Update Interval. <i>Format:</i> ! U1 getvar "netmanage.avalanche.interval"



Example • This example sets the interval value to 3 seconds.

```
! U1 setvar "netmanage.avalanche.interval" "3000"
```



Note •

- For printer support, see [SGD Command Support on page 1267](#).
- For details on SGD command structure, see [Command Structure on page 635](#).

netmanage.avalanche.interval_update

Description This parameter turns on or off the Network Management Update Interval. This command is related to [netmanage.avalanche.interval](#) on page 815.

Supported Devices ZT200 Series

Type setvar;setvar

Commands	Details
setvar	This command turns on or off the network management interval update. <i>Format:</i> ! U1 setvar "netmanage.avalanche.interval_update" "value" <i>Values:</i> "off" "on" <i>Default:</i> "off"
getvar	This command retrieves the current network management interval update setting. <i>Format:</i> ! U1 getvar "netmanage.avalanche.interval_update"



Example • This example sets the device's Network Management Interval Update setting to "on".

```
! U1 setvar "netmanage.avalanche.interval_update" "on"
```



Note •

- For printer support, see [SGD Command Support](#) on page 1267.
- For details on SGD command structure, see [Command Structure](#) on page 635.

netmanage.avalanche.model_name

Description This command obtains or sets the current Network Management Device Model Name stored in the printer.

Supported Devices ZT200 Series

Type setvar;setvar

Commands	Details
setvar	This command sets the current Network Management Device model name. <i>Format:</i> ! U1 setvar "netmanage.avalanche.model_name" "value" <i>Values:</i> a string up to 31 characters in length. <i>Default Value:</i> NA
getvar	This command retrieves the current Network Management Device model name. <i>Format:</i> ! U1 getvar "netmanage.avalanche.model_name"



Example •

```
! U1 setvar "netmanage.avalanche.model_name" "ZT230"
```



Note •

- For printer support, see [SGD Command Support on page 1267](#).
- For details on SGD command structure, see [Command Structure on page 635](#).

netmanage.avalanche.set_property

Description This parameter sets Network Management Device Side Property (custom).

Supported Devices ZT200 Series

Type setvar;getvar;do

Commands	Details
setvar	This parameter sets Network Management Device Side Property (custom). <i>Format:</i> ! U1 setvar "netmanage.avalanche.set_property" "value" <i>Values:</i> A string in the format of "AAAA=XXXXXXXX"
getvar	This parameter retrieves the current Network Management Device Side Property value. <i>Format:</i> ! U1 getvar "netmanage.avalanche.set_property"

➔ **Example 1** • This example will be viewed as a property under the general property tree in avalanche console.

```
! U1 setvar netmanage.avalanche.set_property "ZebraLocation=VH"
```

➔ **Example 2** • This example will be viewed as a property under the Zebra tree in avalanche console.

```
! U1 setvar netmanage.avalanche.set_property "Zebra.Location=VH"
```



Note •

- For printer support, see [SGD Command Support](#) on page 1267.
- For details on SGD command structure, see [Command Structure](#) on page 635.

netmanage.avalanche.startup_update

Description This parameter sets and retrieves the Network Management Start Up Update setting.

Supported Devices ZT200 Series

Type setvar;setvar

Commands	Details
setvar	<p>This command sets the device's Network Management Start Up Update setting.</p> <p><i>Format:</i> ! U1 setvar "netmanage.avalanche.startup_update" "value"</p> <p><i>Values:</i> "off" "on"</p> <p><i>Default:</i> "off"</p>
getvar	<p>This command retrieves the device's current Network Management Start Up Update setting.</p> <p><i>Format:</i> ! U1 getvar "netmanage.avalanche.startup_update"</p>



Example •

```
! U1 setvar "netmanage.avalanche.startup_update" "on"
```



Note •

- For printer support, see [SGD Command Support on page 1267](#).
- For details on SGD command structure, see [Command Structure on page 635](#).

netmanage.avalanche.tcp_connection_timeout

Description This command sets the Network Management Timeout used for establishing a TCP connection to an Agent. Time is set in milliseconds.

Supported Devices ZT200 Series

Type setvar;getvar

Commands	Details
setvar	This command sets the Network Management Timeout used for establishing a TCP connection to an Agent. <i>Format:</i> ! U1 setvar "netmanage.avalanche.tcp_connection_timeout" "value" <i>Values:</i> any integer value from "0" to "4294967295" (4,294,967,295 milliseconds) <i>Default:</i> "0"
getvar	This command retrieves the current Network Management Timeout used for establishing a TCP connection to an Agent. <i>Format:</i> ! U1 getvar "netmanage.avalanche.tcp_connection_timeout"



Example • This examples sets the connection timeout to 2000 milliseconds (2 seconds).

```
! U1 setvar "netmanage.avalanche.tcp_connection_timeout" "2000"
```



Note •

- For printer support, see [SGD Command Support on page 1267](#).
- For details on SGD command structure, see [Command Structure on page 635](#).

netmanage.avalanche.text_msg.beep

Description This parameter sets and gets Network Management Text Message Beep enable setting.

Supported Devices ZT200 Series

Type setvar;setvar

Commands	Details
setvar	<p>This command sets Network Management Text Message Beep enable setting.</p> <p><i>Format:</i> ! U1 setvar "netmanage.avalanche.text_msg.beep" "value"</p> <p><i>Values:</i></p> <p style="padding-left: 20px;">"off"</p> <p style="padding-left: 20px;">"on"</p> <p><i>Default:</i> "off"</p>
getvar	<p>This command retrieves the Network Management Text Message Beep enable setting.</p> <p><i>Format:</i> ! U1 getvar "netmanage.avalanche.text_msg.beep"</p>



Example •

```
! U1 setvar "netmanage.avalanche.text_msg.beep" "on"
```



Note •

- For printer support, see [SGD Command Support on page 1267](#).
- For details on SGD command structure, see [Command Structure on page 635](#).

netmanage.avalanche.text_msg.display

Description This command turns on and off the Network Management Text Message Display setting.

Supported Devices ZT200 Series

Type setvar;setvar

Commands	Details
setvar	This command retrieves the device's Network Management Text Message Display enable setting. <i>Format:</i> ! U1 setvar "netmanage.avalanche.text_msg.display" "value" <i>Values:</i> "off" "on" <i>Default:</i> "off"
getvar	This command returns the current Network Management Text Message Display enable setting. <i>Format:</i> ! U1 getvar "netmanage.avalanche.text_msg.display"



Example •

```
! U1 setvar "netmanage.avalanche.text_msg.display" "on"
```



Note •

- For printer support, see [SGD Command Support on page 1267](#).
- For details on SGD command structure, see [Command Structure on page 635](#).

netmanage.avalanche.text_msg.print

Description This command turns on and off the Network Management Text Message Print setting.

Supported Devices ZT200 Series

Type setvar;setvar

Commands	Details
setvar	<p>This command retrieves the device's Network Management Text Message Print enable setting.</p> <p><i>Format:</i> ! U1 setvar "netmanage.avalanche.text_msg.print" "value"</p> <p><i>Values:</i> "off" "on"</p> <p><i>Default:</i> "off"</p>
getvar	<p>This command returns the current Network Management Text Message Print enable setting.</p> <p><i>Format:</i> ! U1 getvar "netmanage.avalanche.text_msg.print"</p>



Example •

```
! U1 setvar "netmanage.avalanche.text_msg.print" "on"
```



Note •

- For printer support, see [SGD Command Support](#) on page 1267.
- For details on SGD command structure, see [Command Structure](#) on page 635.

netmanage.avalanche.udp_timeout

Description This command sets the device's Network Management UDP timeout. Time is set in milliseconds.

Supported Devices ZT200 Series

Type setvar;getvar

Commands	Details
setvar	This command sets the device's Network Management UDP timeout. <i>Format:</i> ! U1 setvar "netmanage.avalanche.udp_timeout" "value" <i>Values:</i> any integer value from "0" to "4294967295" (4,294,967,295 milliseconds) <i>Default:</i> "0"
getvar	This command returns the current Network Management UDP timeout setting. <i>Format:</i> ! U1 getvar "netmanage.avalanche.udp_timeout"



Example • This example sets the timeout value to .4 seconds (400 milliseconds).
! U1 setvar "netmanage.avalanche.udp_timeout" "400"



Note •

- For printer support, see [SGD Command Support on page 1267](#).
- For details on SGD command structure, see [Command Structure on page 635](#).

odometer.headclean

Description This printer setting refers to the head clean odometer count. This counter tracks how many inches and centimeters have passed through the printer since the head was last cleaned.

Type setvar;getvar

Commands	Details
setvar	This command instructs the printer to reset the head clean counter. <i>Format:</i> ! U1 setvar "odometer.headclean" "value" <i>Values:</i> "0" = reset the head clean counter <i>Default:</i> must be an accepted value or it is ignored
getvar	This command instructs the printer to retrieve the values for the head clean counter. <i>Format:</i> ! U1 getvar "odometer.headclean"



Example • This example shows how to get the odometer head clean, how to reset it, and how to confirm the settings changed.

- To see the current settings, type:
! U1 getvar "odometer.headclean"
Something similar to this is shown:
"1489 INCHES, 3784 CENTIMETERS"
- To reset the these values to 0, type:
! U1 setvar "odometer.headclean" "0"
- To confirm this settings were reset, type:
! U1 getvar "odometer.headclean"
If the resetting was successful, this is shown:
"0 INCHES, 0 CENTIMETERS"



Note •

- For printer support, see [SGD Command Support on page 1267](#).
- For details on SGD command structure, see [Command Structure on page 635](#).

odometer.headnew

Description This printer setting refers to the head replaced odometer count. This counter tracks how many inches and centimeter passed through the printer since the head was last replaced.

Type setvar;getvar

Commands	Details
setvar	This command instructs the printer to reset the head new counter. <i>Format:</i> ! U1 setvar "odometer.headnew" "value" <i>Values:</i> "0" = resets the head new counter <i>Default:</i> must be an accepted value or it is ignored
getvar	This command instructs the printer to retrieve the values for the head new counter. <i>Format:</i> ! U1 getvar "odometer.headnew"



Example • This example shows how to get the odometer head new, how to reset it, and how to confirm the settings changed:

- To see the current settings, type:
! U1 getvar "odometer.headnew"
Something similar to this is shown:
"1489 INCHES, 3784 CENTIMETERS"
- To reset the these values to 0, type:
! U1 setvar "odometer.headnew" "0"
- To confirm this settings were reset, type:
! U1 getvar "odometer.headnew"
If the resetting was successful, this is shown:
"0 INCHES, 0 CENTIMETERS"



Note •

- For printer support, see [SGD Command Support on page 1267](#).
- For details on SGD command structure, see [Command Structure on page 635](#).

odometer.label_dot_length

Description This command returns the length of the last label printed or fed (in dots).

Type `getvar`

Commands	Details
<code>getvar</code>	<p>This command returns the length of the last label printed or fed (in dots).</p> <p><i>Format:</i></p> <pre>! U1 getvar "odometer.label_dot_length"</pre>



Example • This is an example of how to reset the length using the `^LL` command and how to use the `getvar` to confirm the change. For the `^LL` command to work the printer must be in continuous mode.

1. To change the odometer label dot length, type:

```
^XA
```

```
^LL500
```

```
^XZ
```

2. To get the current odometer label dot length, type:

```
! U1 getvar "odometer.label_dot_length"
```

Something similar to this is shown:

```
"500"
```



Note •

- For printer support, see [SGD Command Support on page 1267](#).
- For details on SGD command structure, see [Command Structure on page 635](#).

odometer.media_marker_count1

Description This printer setting refers to the value of the first (count1) user resettable counter. The user resettable counters track how much media has passed through the printer in both inches or centimeters.

Type setvar;setvar

Commands	Details
setvar	This command instructs the printer to reset the first user resettable counter. <i>Format:</i> <code>! U1 setvar "odometer.media_marker_count1" "value"</code> <i>Values:</i> "0" = reset the counter <i>Default:</i> must be an accepted value or it is ignored
getvar	This command instructs the printer to return the current value of the first (count1) user resettable counter in both inches and centimeters. <i>Format:</i> <code>! U1 getvar "odometer.media_marker_count1"</code>



Example • This example shows how to get the first user resettable counter, how to reset it, and how to confirm the settings have changed:

1. To see the current settings, type:
`! U1 getvar "odometer.media_marker_count1"`
Something similar to this is shown:
`"8516 INCHES, 21632 CENTIMETERS"`
2. To reset the these values to 0, type:
`! U1 setvar "odometer.media_marker_count1" "0"`
3. To confirm these settings were reset, type:
`! U1 getvar "odometer.media_marker_count1"`
If the resetting was successful, this is shown:
`"0 INCHES, 0 CENTIMETERS"`



Note •

- For printer support, see [SGD Command Support on page 1267](#).
- For details on SGD command structure, see [Command Structure on page 635](#).

odometer.media_marker_count2

Description This printer setting refers to the value of the second (count2) user resettable counter. The user resettable counters track how much media has passed through the printer in both inches or centimeters.

Type setvar;getvar

Commands	Details
setvar	<p>This command instructs the printer to reset the second user resettable counter.</p> <p><i>Format:</i></p> <pre>! U1 setvar "odometer.media_marker_count2" "value"</pre> <p><i>Values:</i></p> <p>"0" = reset the counter</p> <p><i>Default:</i> must be an accepted value or it is ignored</p>
getvar	<p>This command instructs the printer to return the current value of the second (count2) user resettable counter in both inches and centimeters.</p> <p><i>Format:</i> ! U1 getvar "odometer.media_marker_count2"</p>



Example • This example shows how to get the second user resettable counter, how to reset it, and how to confirm the settings have changed:

1. To see the current settings, type:

```
! U1 getvar "odometer.media_marker_count2"
```

 Something similar to this is shown:

```
"8516 INCHES, 21632 CENTIMETERS"
```
2. To reset the these values to 0, type:

```
! U1 setvar "odometer.media_marker_count2" "0"
```
3. To confirm these settings were reset, type:

```
! U1 getvar "odometer.media_marker_count2"
```

 If the resetting was successful, this is shown:

```
"0 INCHES, 0 CENTIMETERS"
```



Note •

- For printer support, see [SGD Command Support on page 1267](#).
- For details on SGD command structure, see [Command Structure on page 635](#).

odometer.retracts_count

Description This printer value records the number of times a label has been retracted since the last time the counter has been reset.

Supported Devices

- KR403

Type setvar;getvar

Commands	Details
setvar	This command instructs the printer to reset the current count of retractions. <i>Format:</i> <code>! U1 setvar "odometer.retracts_count" "value"</code> <i>Values:</i> 0 = reset the counter <i>Default:</i> none
getvar	This command instructs the printer to respond with the current number of retractions that have happened since the last time the counter was reset. <i>Format:</i> <code>! U1 getvar "odometer.retracts_count"</code>



Note •

- For printer support, see [SGD Command Support on page 1267](#).
- For details on SGD command structure, see [Command Structure on page 635](#).

odometer.total_print_length

Description This command tracks the total length of media that printed over the life of the printer.

Type `getvar`

Commands	Details
<code>getvar</code>	This command returns the value of the total length of media that printed over the life of the printer. <i>Format:</i> <code>! U1 getvar "odometer.total_print_length"</code>



Example • This example shows how to get the total length of media that printed over the life of the printer.

- To get the total length of media that has printed to date, type:
`! U1 getvar "odometer.total_print_length"`

Something similar to this is shown:

`"8560 INCHES, 21744 CENTIMETERS"`



Note •

- For printer support, see [SGD Command Support on page 1267](#).
- For details on SGD command structure, see [Command Structure on page 635](#).

odometer.rfid.valid_resetable

Description This command resets the RFID valid label counter to zero.

Type getvar; setvar

This table identifies the command for this format:

Commands	Details
setvar	This command instructs the printer to set the RFID valid counter to zero. <i>Format:</i> ! U1 setvar "odometer.rfid.valid_resetable" "value" <i>Values:</i> "0"
getvar	This command instructs the printer to respond with the current RFID valid counter value. <i>Format:</i> ! U1 getvar "odometer.rfid.valid_resetable"

→ **Example** • This `setvar` example shows how the counter portion of the printer configuration labels looks when the RFID valid counter is reset by sending:

```
! U1 setvar "odometer.rfid.valid_resetable" "0"
```

Before

```

TM:M6E MICRO..... RFID READER
20.00.00.01..... RFID HW VERSION
01.01.00.EA..... RFID FW VERSION
USA/CANADA..... RFID REGION CODE
USA/CANADA..... RFID COUNTRY CODE
RFID OK..... RFID ERR STATUS
16..... RFID READ PWR
16..... RFID WRITE PWR
F0..... PROG. POSITION
507..... RFID VALID CTR
4..... RFID VOID CTR

```

After

```

TM:M6E MICRO..... RFID READER
20.00.00.01..... RFID HW VERSION
01.01.00.EA..... RFID FW VERSION
USA/CANADA..... RFID REGION CODE
USA/CANADA..... RFID COUNTRY CODE
RFID OK..... RFID ERR STATUS
16..... RFID READ PWR
16..... RFID WRITE PWR
F0..... PROG. POSITION
0..... RFID VALID CTR
4..... RFID VOID CTR

```

odometer.rfid.void_resetable

Description This command resets the RFID void label counter to zero.

Type setvar; getvar

This table identifies the command for this format:

Commands	Details
setvar	This command instructs the printer to set the RFID void counter to zero. <i>Format:</i> ! U1 setvar "odometer.rfid.void_resetable" "value" <i>Values:</i> "0"
getvar	This command instructs the printer to respond with the current RFID void counter value. <i>Format:</i> ! U1 getvar "odometer.rfid.void_resetable"

→ **Example** • This `setvar` example shows how the counter portion of the printer configuration labels looks when the RFID void counter is reset by sending:

```
! U1 setvar "odometer.rfid.valid_resetable" "0"
```

Before

```
TM:M6E MICRO..... RFID READER
20.00.00.01..... RFID HW VERSION
01.01.00.EA..... RFID FW VERSION
USA/CANADA..... RFID REGION CODE
USA/CANADA..... RFID COUNTRY CODE
RFID OK..... RFID ERR STATUS
16..... RFID READ PWR
16..... RFID WRITE PWR
F0..... PROG. POSITION
507..... RFID VALID CTR
4..... RFID VOID CTR
```

After

```
TM:M6E MICRO..... RFID READER
20.00.00.01..... RFID HW VERSION
01.01.00.EA..... RFID FW VERSION
USA/CANADA..... RFID REGION CODE
USA/CANADA..... RFID COUNTRY CODE
RFID OK..... RFID ERR STATUS
16..... RFID READ PWR
16..... RFID WRITE PWR
F0..... PROG. POSITION
507..... RFID VALID CTR
0..... RFID VOID CTR
```

parallel_port.mode

Description This command sets the mode type for the parallel port.

Supported Devices ZT200 Series

Type setvar;setvar

Commands	Details
setvar	This command sets the mode type for the parallel port. <i>Format:</i> ! U1 setvar "parallel_port.mode" "value" <i>Values:</i> "bidirectional" "unidirectional" <i>Default:</i> "bidirectional"
getvar	This command retrieves the current mode type setting for the parallel port. <i>Format:</i> ! U1 getvar "parallel_port.mode"



Example •

```
! U1 setvar "parallel_port.mode" "bidirectional"
```



Note •

- For printer support, see [SGD Command Support on page 1267](#).
- For details on SGD command structure, see [Command Structure on page 635](#).

parallel_port.present

Description This command reports if there is a parallel port in the printer.

Supported Devices ZT200 Series

Type `getvar`

Commands	Details
<code>getvar</code>	<p>This command reports if there is a parallel port in the printer.</p> <p><i>Format:</i> <code>! U1 getvar "parallel_port.present"</code></p> <p><i>Result:</i></p> <p style="padding-left: 20px;"><code>"present"</code></p> <p style="padding-left: 20px;"><code>"not installed"</code></p>



Note •

- For printer support, see [SGD Command Support on page 1267](#).
- For details on SGD command structure, see [Command Structure on page 635](#).

power.dtr_power_off

Description This command refers to the remote printer power control, and is used for power management. When Data Terminal Ready (DTR) is enabled the printer can be powered on and off via the Data Set Ready (DSR) signal. When DTR power off is enabled, a low to high transition will cause the printer to turn ON and a high to low transition will cause the printer to turn OFF.



Note • The inactivity time-out is disabled while DSR is active.

Supported Devices ZT200 Series

Type setvar;getvar

Commands	Details
setvar	This command instructs the printer to turn DTR power on or off. <i>Format:</i> ! U1 setvar "power.dtr_power_off" "value" <i>Values:</i> "off" "on" <i>Default:</i> "on"
getvar	This command retrieves the current DTR power-off setting. <i>Format:</i> ! U1 getvar "power.dtr_power_off"



Example •

```
! U1 setvar "power.dtr_power_off" "off"
```



Note •

- For printer support, see [SGD Command Support on page 1267](#).
- For details on SGD command structure, see [Command Structure on page 635](#).

print.tone

Description This command specifies the printer darkness.

Type setvar;getvar

Commands	Details
setvar	<p>This command instructs the printer to set the darkness and relative darkness.</p> <p><i>Format:</i> ! U1 setvar "print.tone" "value"</p> <p><i>Values:</i></p> <p>"0.0" to "30.0" = darkness</p> <p>"-0.1" to "-30.0" and "+0.1" to "+30.0" = incremental adjustments</p> <p><i>Default:</i> "4.0"</p>
getvar	<p>This command retrieves the printer's current darkness setting.</p> <p><i>Format:</i> ! U1 getvar "print.tone"</p>



Example • This `setvar` example shows the value set to "4.0".

```
! U1 setvar "print.tone" "4.0"
```

When the `setvar` value is set to "4.0", the `getvar` result is "4.0".



Note •

- For printer support, see [SGD Command Support on page 1267](#).
- For details on SGD command structure, see [Command Structure on page 635](#).

rfid.adaptive_antenna

Description This command enables or disables adaptive antenna selection. For printer support, see [SGD Command Support on page 1029](#).

If the printer cannot find RFID tags with the antenna element specified during the number of retries specified (if applicable), the printer may try neighboring antenna elements. If the printer is unsuccessful communicating with the RFID tag after trying the neighboring antenna elements, the printer voids the label.

Type setvar; getvar



Note • For details on SGD command structure, see [Command Structure on page 658](#).

Commands	Details
setvar	<p>Enables or disables the adaptive antenna feature.</p> <p> Note •</p> <ul style="list-style-type: none"> • This command is valid only on R110Xi4 and ZT400 printers with a label that is 2 in. (51 mm) or longer. • Activating this feature may slow throughput on damaged or weak RFID tags. • <p><i>Format:</i> ! U1 setvar "rfid.adaptive_antenna" "value"</p> <p><i>Values:</i></p> <p>none = The printer uses only the current antenna element selection.</p> <p>neighbors = The printer attempts to read the tag using the antenna elements to the left/right and above/below the current antenna. The antenna element that is successful is used for all subsequent RFID commands until the next unsuccessful attempt.</p> <p><i>Default Value:</i> none</p>
getvar	<p>Retrieves the current adaptive antenna setting.</p> <p><i>Format:</i> ! U1 getvar "rfid.adaptive_antenna"</p>

rfid.antenna_sweep

Description This command enables/disables the antenna sweep feature. For printer support, see [SGD Command Support on page 1029](#).

If the RFID media loaded in the printer is known to be in range of an antenna at the F0 programming position, you can avoid RFID calibration by using the RFID antenna sweep feature. With this feature enabled, when the first RFID format is sent after a printer powerup or printhead close, the printer scans through the antennas to find the optimal antenna element.

Type setvar; getvar



Note • For details on SGD command structure, see [Command Structure on page 658](#).

Commands	Details
setvar	<p>Enables or disables the antenna sweep feature.</p> <p> Note • This command is valid only on R110Xi4 and ZT400 printers with a label that is 2 in. (51 mm) or longer and when using a program position of F0.</p> <p><i>Format:</i> ! U1 setvar "rfid.antenna_sweep" "value" <i>Values:</i> on, off <i>Default Value:</i> on</p>
getvar	<p>Retrieves the current antenna sweep setting.</p> <p><i>Format:</i> ! U1 getvar "rfid.adaptive_antenna"</p>

rfid.country_code

Description This command sets or returns the RFID reader country code. The country code is restricted based on the region code assigned to the reader and, in some instances, cannot be modified. You can check the countries available for your region through the control panel menu items on your printer.

Type setvar; getvar

Commands	Details
setvar	Sets the RFID reader's current country code. <i>Format:</i> ! U1 setvar "rfid.country_code" "value" <i>Values:</i> The country code choices available will vary depending on the region for which your printer is configured.
getvar	Retrieves the RFID reader's current country code. <i>Format:</i> ! U1 getvar "rfid.country_code"



Example • In this example, the `setvar` sets the country code to USA/Canada.
! U1 setvar "rfid.country_code" "usa/canada"

rfid.enable

Description This command instructs an RFID printer to enable or disable RFID functionality. You must restart the printer for the command to take effect.



Note • When this function is set to "on," changes are made to normal printer functionality. Loading printer defaults does NOT:

- Default the sensor select setting
- Default media tracking sensor settings
- Default label length
- Perform an auto calibration

Type setvar

Commands	Details
setvar	Enables or disables RFID functionality. <i>Format:</i> ! U1 setvar "rfid.enable" "value" <i>Values:</i> on = enables RFID functionality off = disables RFID functionality <i>Default Value:</i> on

rfid.error.response

Description This command can be used to retrieve the RFID status, including any error codes or messages. See *RFID Error Codes and Messages on page 43* for more information.

Type `getvar`

Commands	Details
<code>getvar</code>	Retrieves any active RFID error messages. <i>Format: ! U1 getvar "rfid.error.response"</i>



Example • This `getvar` example shows responses that you may get in different situations:

```
! U1 getvar "rfid.error.response"
```

If no RFID tag is present, you get the following response:

```
NO TAG FOUND
```

If an RFID tag is present and there are no errors, you get the following response:

```
RFID OK
```

rfid.hop_table_version

Description This command retrieves the RFID reader's hop table version. For printer support, see *SGD Command Support* on page 1029.

Type `getvar`



Note • For details on SGD command structure, see *Command Structure* on page 658.

Commands	Details
getvar	Retrieves the RFID reader's hop table version. <i>Format:</i> ! U1 getvar "rfid.hop_table_version"

rfid.position.program

Description This command sets the read/write position of the tag (programming position). For more information, see [Using the Correct RFID Settings on page 18](#).



Important • If this command is used to specify a value for the programming position, this value will be used for the programming position for all labels until a new position is specified or until the tag calibration procedure is run.

Type setvar; getvar

Commands	Details
setvar	<p>This command instructs the printer to set the read/write position of the RFID tag.</p> <p><i>Format:</i> ! U1 setvar "rfid.position.program" "value"</p> <p><i>Values:</i></p> <p>F0 to Fxxx (where xxx is the label length in millimeters or 999, whichever is less) The printer prints the first part of a label until it reaches the specified distance and then begins programming. After programming, the printer prints the remainder of the label.</p> <p>B0 to B30 The printer backfeeds the label for the specified distance and then begins programming. To account for the backfeed, allow empty media liner to extend out of the front of the printer when using a backward programming position.</p> <p>up = move to the next value down = move to the previous value</p> <p><i>Default:</i> F0 (which moves the leading edge of the label to the print line)</p>
getvar	<p>This command instructs the printer to respond with the current programming position.</p> <p><i>Format:</i> ! U1 getvar "rfid.position.program"</p>



Example • This example shows the programming position being set at 15 mm from the leading edge of the label.

```
! U1 setvar "rfid.position.program" "F15"
```

When the **setvar** value is set to "F15", the **getvar** result is **F15**.

rfid.reader_1.antenna_port

Description This command specifies the RFID antenna to be used for RFID operation.



Note • Some printers automatically select the best antenna element and read/write power levels for the media during RFID transponder calibration. Ty may also set the levels during an adaptive antenna sweep. Use the `~HL` command (see [^HL or ~HL on page 385](#)) to view the antenna element and power settings being used.

Type `setvar;` `getvar`

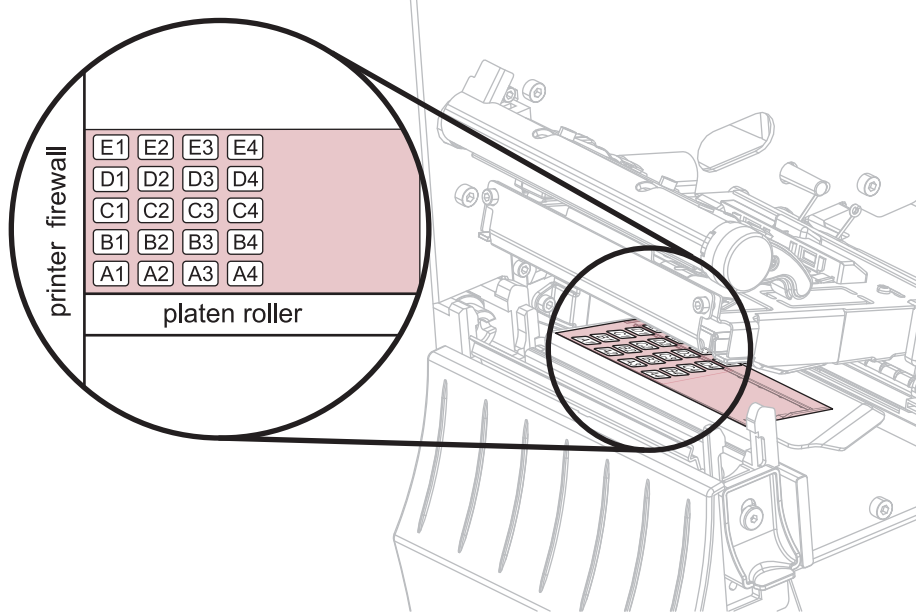
Commands	Details
setvar	<p>Sets the antenna port.</p> <p><i>Format: ! U1 setvar "rfid.reader_1.antenna_port" "value"</i></p> <p>ZD500R: This printer only has one antenna element, so the value used is always A1. <i>Default Value: A1</i></p> <p>ZT400 Series: This parameter selects an antenna element from the printer's antenna array. <i>Accepted Values:</i></p> <p>E1, E2, E3, E4 D1, D2, D3, D4 C1, C2, C3, C4 B1, B2, B3, B4 A1, A2, A3, A4</p>  <p><i>Default Value: A4</i></p>
getvar	<p>Retrieves the current antenna port.</p> <p><i>Format: ! U1 getvar "rfid.reader_1.antenna_port"</i></p>



Example • This `setvar` example shows the selection of antenna port D3.

```
! U1 setvar "rfid.reader_1.antenna_port" "D3"
```

When the `setvar` value is set to "D3", the `getvar` result is "D3".

rfid.reader_1.power.read

Description This command sets the RFID reader power level for reading RFID tags.

Type setvar; getvar

Commands	Details
setvar	Sets the antenna's read power level. <i>Format:</i> ! U1 setvar "rfid.reader_1.power.read" "value" <i>Values:</i> 0 to 30 up = increase the current value by 1 down = decrease the current value by 1 <i>Default:</i> 16
getvar	Retrieves the antenna's current read power level. <i>Format:</i> ! U1 getvar "rfid.reader_1.power.read"



Example • This setvar example sets the antenna to power setting 16 for reading RFID tags.

! U1 setvar "rfid.reader_1.power.read" "16"

When the setvar value is set to "16", the getvar result is 16.

rfid.reader_1.power.write

Description Use this command to set the RFID write power levels if the desired levels are not achieved through RFID tag calibration. If not enough power is applied, the tag may not have sufficient power for programming, and tag data will fail to encode. If too much power is applied, the extra power may cause data communication errors or may cause the wrong tag to be programmed.

Type setvar; getvar

This table identifies the command for this format:

Commands	Details
setvar	<p>Sets the antenna's read power level.</p> <p><i>Format:</i> ! U1 setvar "rfid.reader_1.power.write" "value"</p> <p><i>Values:</i></p> <ul style="list-style-type: none"> 0 to 30 up = increase the current value by 1 down = decrease the current value by 1 <p><i>Default:</i> 16</p>
getvar	<p>Retrieves the antenna's current write power level.</p> <p><i>Format:</i> ! U1 getvar "rfid.reader_1.power.write"</p>



Example • This setvar example sets the antenna to power setting 16 for writing to RFID tags.

```
! U1 setvar "rfid.reader_1.power.write" "16"
```

When the setvar value is set to "16", the getvar result is 16.

rfid.reader_1.power.single_power

Description This command sets the RFID reader power level for reading and writing to RFID tags for readers with a single power level.



Note • This command applies only to the R110Xi HF printer, firmware version R65.X.

Type setvar;getvar

Commands	Details
setvar	<p>This command instructs the printer to set the power level for reading and writing.</p> <p><i>Format:</i> ! U1 setvar "rfid.reader_1.power.single_power" "value"</p> <p><i>Values:</i></p> <ul style="list-style-type: none"> high medium low <p><i>Default:</i> low</p>
getvar	<p>This command instructs the printer to respond with the current power level.</p> <p><i>Format:</i> ! U1 getvar "rfid.reader_1.power.single_power"</p>



Example • This `setvar` example sets the antenna to high power for writing to RFID tags.

```
! U1 setvar "rfid.reader_1.power.single_power" "high"
```

When the `setvar` value is set to "high", the `getvar` result is "high".



Note •

- For printer support, see [SGD Command Support on page 1267](#).
- For details on SGD command structure, see [Command Structure on page 635](#).

rfid.reader_1.firmware_version

Description This command returns the RFID reader firmware version.

Type `getvar`

Commands	Details
<code>getvar</code>	<i>Format:</i> <code>! U1 getvar "rfid.reader_1.firmware_version"</code>



Example • This example shows responses that you get in different situations:

```
! U1 getvar "rfid.reader_1.firmware_version"
```

If an RFID reader is present and connected, you get the firmware version in the following format:

```
xx.xx.xx.xx
```

If there is no RFID reader or if the reader is not connected correctly, the response is blank.

rfid.reader_1.hardware_version

Description This command returns the RFID reader hardware version.

Type `getvar`

Commands	Details
<code>getvar</code>	<i>Format:</i> <code>! U1 getvar "rfid.reader_1.hardware_version"</code>



Example • This example shows responses that you get in different situations:

`! U1 getvar "rfid.reader_1.hardware_version"`

If an RFID reader is present and connected, you get the hardware version in the following format:

`xx.xx.xx.xx`

If there is no RFID reader or if the reader is not connected correctly, the response is blank.

rfid.reader_1.model

Description This command returns the printer's RFID reader model number. Possible values are as follows:

- M6E MICRO

Type `getvar`

Commands	Details
<code>getvar</code>	<i>Format:</i> ! U1 <code>getvar "rfid.reader_1.model"</code>

rfid.region_code

Description This command returns the region code assigned to the printer’s RFID device. Possible values are as follows:

- not available
- usa/canada
- japan
- rest of world

Type getvar



Note • For details on SGD command structure, see [Command Structure on page 658](#).

Commands	Details
getvar	Retrieves the RFID region code. <i>Format: ! U1 getvar "rfid.region_code"</i>

rfid.tag.calibrate

Description Use this command to initiate tag calibration for RFID media. During the process, the printer moves the media, calibrates the RFID tag position, and determines the optimal settings for the RFID media being used. Depending on the printer, these settings include the programming position, the antenna element to use, and the read/write power level to use.



Important • Before running this command, load the printer with RFID media, calibrate your printer, close the printhead, and feed at least one label to make sure that tag calibration will begin from the correct position. For more information on media calibration, refer to the User Guide for your printer.

Leave all transponders before and after the tag that is being calibrated. This allows the printer to determine RFID settings which do not encode the adjacent tag. Allow a portion of media to extend out the front of the printer to allow for backfeed during the tag calibration procedure.

Type `setvar`

Commands	Details
<code>setvar</code>	<p>Initiates tag calibration for RFID media.</p> <p><i>Format:</i> <code>! U1 setvar "rfid.tag.calibrate" "value"</code></p> <p><i>Values:</i></p> <ul style="list-style-type: none"> <code>restore</code> <code>run</code>

➔ **Example 1** • This `setvar` example restores the programming position back to the printer's default value.

```
! U1 setvar "rfid.tag.calibrate" "restore"
```

➔ **Example 2** • This `setvar` example performs RFID tag calibration.

```
! U1 setvar "rfid.tag.calibrate" "run"
```

rfid.tag.data

Description This command tells the RFID reader to attempt to read a tag over the RFID antenna, even if the printhead is open. Results are returned to the host.

Before running this command, position an RFID label over the printer’s RFID antenna.

For more information about this option and for the location of the RFID antenna, refer to the *RFID Programming Guide* for your printer. A copy is available online at <http://www.zebra.com/manuals>.

Type `getvar`

Commands	Details
<code>getvar</code>	This command instructs the printer to respond with the current tag’s data. <i>Format: ! U1 getvar "rfid.tag.data"</i>

➔ **Example 1** • This `getvar` example gets the current tag’s data, assuming that an RFID label with data “0123456789ABCDEF12345678” is in place over the antenna.
`! U1 setvar "rfid.tag.data"`
 The printer responds with `0123456789ABCDEF12345678`.

➔ **Example 2** • This `getvar` example gets the current tag’s data, assuming that no tag data can be read or that no tag is present.
`! U1 setvar "rfid.tag.data"`
 The printer responds with `NO DATA`.



Note •

- For printer support, see *SGD Command Support on page 1267*.
- For details on SGD command structure, see *Command Structure on page 635*.

rfid.tag.read.content

Description This command instructs the printer which data to read from the tag with the `rfid.tag.read.execute` command. (See [rfid.tag.read.execute](#) on page 857.)

Type `setvar`, `getvar`

Commands	Details
<code>setvar</code>	<p>Instructs the printer which data to read from the tag with the <code>rfid.tag.read.execute</code> command.</p> <p><i>Format:</i> <code>! U1 setvar "rfid.tag.read.content" "value"</code></p> <p><i>Values:</i></p> <ul style="list-style-type: none"> <code>epc</code> = reads the EPC data based on the EPC size specified in the RFID tag's protocol bits, up to 160 bits <code>tid information</code> = reads the first 32 bits of the TID (Tag ID) <code>password status</code> = reads the tag's access and kill passwords <code>protocol bits</code> = reads the protocol bits from the EPC memory banks and converts that value to the EPC size <code>memory bank sizes</code> = reads the EPC, TID, and user memory banks sizes <code>up</code> = sets the command to the previous test <code>down</code> = sets the command to the next test <p><i>Default Value:</i> <code>epc</code></p>
<code>getvar</code>	<p>Retrieves the current setting.</p> <p><i>Format:</i> <code>! U1 getvar "rfid.tag.read.content"</code></p>

rfid.tag.read.execute

Description This command reads the data specified by the `rfid.tag.read.content` command. (See [rfid.tag.read.content](#) on page 856.)

Type `setvar`

Commands	Details
setvar	Reads the specified data. <i>Format:</i> ! U1 setvar "rfid.tag.read.execute"

rfid.tag.read.result_line1

Description This command reports the results of the `rfid.tag.read.execute` command.

Type `getvar`

Commands	Details
<code>getvar</code>	Retrieves the results of the <code>rfid.tag.read.execute</code> command. <i>Format:</i> ! U1 setvar "rfid.tag.read.result_line1"

rfid.tag.read.result_line2

Description This command reports the results of the `rfid.tag.read.execute` command.

Type `getvar`

Commands	Details
getvar	Retrieves the results of the <code>rfid.tag.read.execute</code> command. <i>Format:</i> ! U1 setvar "rfid.tag.read.result_line2"

rfid.tag.read.result_line1_alternate

Description This command reports the results of the `rfid.tag.read.execute` command.

Type `getvar`

Commands	Details
<code>getvar</code>	Retrieves the results of the <code>rfid.tag.read.execute</code> command. <i>Format:</i> ! U1 setvar "rfid.tag.read.result_line1_alternate"

rfid.tag.read.result_line2_alternate

Description This command reports the results of the `rfid.tag.read.execute` command.

Type `getvar`

Commands	Details
<code>getvar</code>	Retrieves the results of the <code>rfid.tag.read.execute</code> command. <i>Format:</i> ! U1 setvar "rfid.tag.read.result_line2_alternate"

rfid.tag.test

Description This command performs an RFID test. In the RFID test, the printer attempts to read and write to a transponder that you place over the RFID antenna. Results are displayed on the printer’s control panel display. For more information about the RFID antenna location, refer to the *RFID Programming Guide* for your printer. A copy is available online at <http://www.zebra.com/manuals>.

In the slow version of the RFID test, the printer first displays the hardware version, the reader firmware version, and the program position. For printer support, see *SGD Command Support* on page 1267.



Note • This command is valid only on RP4T printers.

Type setvar

Commands	Details
setvar	<p>This command instructs the printer to set the programming position.</p> <p><i>Format:</i> ! U1 setvar "rfid.tag.test" "value"</p> <p><i>Values:</i></p> <ul style="list-style-type: none"> quick slow



Example 1 • This `setvar` example performs a quick RFID test, which shows a pass or fail message.

```
! U1 setvar "rfid.tag.test" "quick"
```



Example 2 • This `setvar` example performs a slow RFID test, which shows the success or failure of each read or write tag operation.

```
! U1 setvar "rfid.tag.test" "slow"
```



Note •

- For printer support, see *SGD Command Support* on page 1267.
- For details on SGD command structure, see *Command Structure* on page 635.

rfid.tag.test.content

Description This command instructs the printer which test to perform on the tag with the `rfid.tag.test.execute` command. (See [rfid.tag.test.execute](#) on page 864.)

Type `setvar`, `getvar`

Commands	Details
<code>setvar</code>	<p>Instructs the printer which test to perform on the tag with the <code>rfid.tag.test.execute</code> command.</p> <p><i>Format:</i> <code>! U1 setvar "rfid.tag.test.content" "value"</code></p> <p><i>Values:</i></p> <ul style="list-style-type: none"> <code>quick</code> = performs a read EPC test and a write EPC test (using random data) <code>read</code> = performs a read EPC test <code>write</code> = performs a write EPC test (using random data) <code>up</code> = sets the command to the previous test <code>down</code> = sets the command to the next test <p><i>Default Value:</i> <code>quick</code></p>
<code>getvar</code>	<p>Retrieves the current setting.</p> <p><i>Format:</i> <code>! U1 getvar "rfid.tag.test.content"</code></p>

rfid.tag.test.execute

Description This command tests the data specified by the `rfid.tag.test.content` command. (See [rfid.tag.test.content](#) on page 863.)

Type setvar

Commands	Details
setvar	Tests the specified data. <i>Format:</i> ! U1 setvar "rfid.tag.test.execute"

rfid.tag.test.result_line1

Description This command reports the results of the `rfid.tag.test.execute` command.

Type `getvar`

Commands	Details
getvar	Retrieves the results of the <code>rfid.tag.test.execute</code> command. <i>Format:</i> ! U1 setvar "rfid.tag.test.result_line1"

rfid.tag.test.result_line2

Description This command reports the results of the `rfid.tag.test.execute` command.

Type `getvar`

Commands	Details
<code>getvar</code>	Retrieves the results of the <code>rfid.tag.test.execute</code> command. <i>Format: ! U1 setvar "rfid.tag.test.result_line2"</i>

rfid.tag.type

Description This command sets the reader's RFID tag type.

Type setvar;setvar

Commands	Details
setvar	<p>This command instructs the printer to set the reader's tag type. For the supported tag types, see Table 26 on page 868.</p> <p><i>Format:</i> ! U1 setvar "rfid.tag.type" "value"</p> <p><i>Values:</i></p> <p>UHF Printers</p> <ul style="list-style-type: none"> none = None class0 = EPC Class 0 class0+ = EPC Class 0 Plus class1_64bit = EPC Class 1 64-bit class1_96bit = EPC Class 1 96-bit ucode_epc_1_19 = UCODE EPC 1.19 class0+_impinj = Impinj Class 0 Plus ISO18000A = ISO 18000-06A gen2 = EPC Class 1, Generation 2 (Gen 2) ISO18000B = ISO 18000-06B <p>HF Printers</p> <ul style="list-style-type: none"> none = None detect = Auto detect (query tag to determine) tagit = Tag*It (Texas Instruments Tagit tags) icode = I*code (Phillips Icode tags) pico = Pico Tag (Inside Technology's) ISO15693 = ISO 15693 EPC = EPC tag (13.56 MHz) UIC = UID Tag mifare_ultralight = Mifare UltraLight
getvar	<p>This command instructs the printer to respond with the reader's current tag type.</p> <p><i>Format:</i> ! U1 getvar "rfid.tag.type"</p>



Example • This setvar example shows the reader's tag type being set to Gen 2.

```
! U1 setvar "rfid.tag.type" "gen2"
```

Supported Tag Types [Table 26](#) shows the tag types supported by different RFID printers/print engines and firmware versions. Depending on your country or on the firmware version that you are using, your printer may not support all of the tag types listed. If you specify an unsupported tag type, the printer uses the default value. If a tag type is shown as supported but does not work with your printer, you may need to upgrade the printer's firmware (see <http://www.zebra.com/firmware>).

Table 26 • Supported Tag Types and Default Values

Printer	UHF Printers											HF Printers							
	R110Xi4	R110Xi/ R170Xi		R110PAX4			R4Mplus				RZ400/ RZ600	R110Xi HF		R2844-Z					
Firmware Version	V53.17.7 and later	R60.13.X	R60.15.X and later		R62.13.X	R62.15.X and later		R63.13.X	R63.15.X and later		SP9940, SP999E, SP1027E, SP1082E, and earlier	SP994P, SP999F, SP1027F, SP1082F, and later	SP1056D and earlier	SP1056E and later	R53.16.X and later	R65.13.X	R65.15.X and later		all
Tag Type																			
UHF Tag Types and Options																			
None (no tag type specified)	—	*	*	*	*	—	—	—	—	—	—	—	—	—	—	—	—	—	—
EPC Class 0	—	*	*	*	*	—	—	—	—	—	—	—	—	—	—	—	—	—	—
EPC Class 0 Plus	—	*	*	*	*	—	—	—	—	—	—	—	—	—	—	—	—	—	—
EPC Class 1 64-bit	—	*	*	*	*	—	—	—	—	—	—	—	—	—	—	—	—	—	—
EPC Class 1 96-bit	—	#	*	#	*	—	*	*	*	—	—	—	—	—	—	—	—	—	—
UCODE EPC 1.19	—	* a	*	—	*	#	*	#	*	#	*	—	—	—	—	—	—	—	—
Impinj Class 0 Plus	—	*	*	*	*	—	—	—	—	—	—	—	—	—	—	—	—	—	—
ISO 18000-06A	—	—	—	*	—	—	*	*	*	—	—	—	—	—	—	—	—	—	—
EPC Class 1, Generation 2 (Gen 2)	#	*	#	*	#	—	#	*	#	*	#	#	—	—	—	—	—	—	—
ISO 18000-06B	—	*	*	*	*	—	*	*	*	*	*	*	—	—	—	—	—	—	—
HF Tag Types and Options																			
Auto-detect the tag type by querying the tag	—	—	—	—	—	—	—	—	—	—	—	—	—	—	—	—	—	—	#
Tag*It (Texas Instruments Tagit tags)	—	—	—	—	—	—	—	—	—	—	—	—	—	—	—	—	—	—	*
I*code (Phillips Icode tags)	—	—	—	—	—	—	—	—	—	—	—	—	—	—	—	—	—	—	*
Pico Tag (Inside Technology's)	—	—	—	—	—	—	—	—	—	—	—	—	—	—	—	—	—	—	*
ISO 15693	—	—	—	—	—	—	—	—	—	—	—	—	—	—	—	#	#	*	*
EPC tag	—	—	—	—	—	—	—	—	—	—	—	—	—	—	—	—	—	—	*
UID Tag	—	—	—	—	—	—	—	—	—	—	—	—	—	—	—	—	—	—	—
Mifare UltraLight	—	—	—	—	—	—	—	—	—	—	—	—	—	—	*	*	—	—	—

= Default value * = Accepted value — = Not supported

a. Requires R60.13.0.13ZD or later.



Note •

- For printer support, see [SGD Command Support on page 1267](#).
- For details on SGD command structure, see [Command Structure on page 635](#).

sensor.cover_open

Description This printer setting determines if the printer media cover is open.

Type `getvar`

Supported Devices ZT400 series

Commands	Details
<code>getvar</code>	Displays if the printer cover is open or not. <i>Format:</i> ! U1 <code>getvar "sensor.cover_open"</code> <i>Values:</i> "yes" = the printer cover is open "no" = the printer cover is closed



Note •

- For printer support, see [SGD Command Support on page 1267](#).
- For details on SGD command structure, see [Command Structure on page 635](#).

usb.device.device_id_string

Description This command retrieves the manufacturer assigned IEEE1284 Device Identification string for USB devices.

Supported Devices ZT200 Series

Type getvar

Commands	Details
getvar	This command retrieves the device ID string. <i>Format:</i> ! U1 getvar "usb.device.device_id_string"



Example •

```
! U1 getvar "usb.device.device_id_string"
```

Result:

```
"MANUFACTURER:Zebra Technologies ;COMMAND SET:ZPL;MODEL:ZTC ZT220-200dpi ZPL;CLASS:PRINTER;OPTIONS:XML;"
```



Note •

- For printer support, see [SGD Command Support on page 1267](#).
- For details on SGD command structure, see [Command Structure on page 635](#).

usb.device.device_unique_id

Description This command sets the USB Unique Device ID setting. The identifier that makes any printer unique is set by the "usb.device.serial_string" command which is reported to the USB driver.

By default "usb.device.serial_string" reports the printer's serial number. If "usb.device_unique_id" is set to "off" the printer will report the usb.device.serial_string parameter as its product family (e.g. ZT230, etc).

When subsequent printers of the same model, with "usb.device_unique_id" parameter to "off", are connected via USB, the host computer will not treat them as a new Plug and Play events, nor require new driver installations.

Supported Devices ZT200 Series

Type setvar;getvar

Commands	Details
setvar	This command sets the current USB Unique Device Id setting. <i>Format:</i> ! U1 setvar "usb.device.device_unique_id" "value" <i>Values:</i> "off" "on" <i>Default:</i> "on"
getvar	This command returns the current USB Unique Device Id setting stored in the printer. <i>Format:</i> ! U1 getvar "usb.device.device_unique_id"



Example •

```
! U1 setvar "usb.device.device_unique_id" "off"
```



Note •

- For printer support, see [SGD Command Support on page 1267](#).
- For details on SGD command structure, see [Command Structure on page 635](#).

usb.device.device_version

Description This command returns the version of the USB device being queried.

Supported Devices ZT200 Series

Type getvar

Commands	Details
getvar	This command instructs the printer to respond with the printer's USB version. <i>Format: ! U1 getvar "usb.device.device_version"</i>



Example •

`! U1 getvar "usb.device.device_version"`

Result: "1.1"



Note •

- For printer support, see [SGD Command Support on page 1267](#).
- For details on SGD command structure, see [Command Structure on page 635](#).

usb.device.manufacturer_string

Description This command retrieves the USB device manufacturer's name.

Supported Devices ZT200 Series

Type getvar

Commands	Details
getvar	This command instructs the printer to respond with the manufacturer name. <i>Format:</i> ! U1 getvar "usb.device.manufacturer_string"



Example •

```
! U1 getvar "usb.device.manufacturer_string"
```

Result: "Zebra Technologies"



Note •

- For printer support, see [SGD Command Support on page 1267](#).
- For details on SGD command structure, see [Command Structure on page 635](#).

usb.device.product_id

Description This command retrieves the Product Identification number that a manufacturer assigned to a particular product. This number, along with the Vendor ID, allows a USB host to distinguish between devices.

Supported Devices ZT200 Series

Type `getvar`

Commands	Details
<code>getvar</code>	This command retrieves the product ID. <i>Format:</i> <code>! U1 getvar "usb.device.product_id"</code>



Example •

```
! U1 getvar "usb.device.product_id"
```

Result: "003D"



Note •

- For printer support, see [SGD Command Support on page 1267](#).
- For details on SGD command structure, see [Command Structure on page 635](#).

usb.device.product_string

Description This command returns the manufacturer-assigned string describing a particular USB product.

Supported Devices

- ZT200 Series
- QLn Series

Type `getvar`

Commands	Details
<code>getvar</code>	This command instructs the printer to respond with the product string description. <i>Format: ! U1 getvar "usb.device.product_string"</i>



Example • Issuing the command on a ZT210 printer:

```
! U1 getvar "usb.device.product_string"  
Result: "ZT210"
```

Issuing the command on a QLn320 printer:

```
! U1 getvar "usb.device.product_string"  
Result: "ZTC QLn320-203dpi CPCL"
```



Note • For firmware V68.19.0 and V72.19.0, the return value was changed to the longer name, which is the same as the USB PID. The QLnXXX is replaced by the printer model and number for each printer.



Note •

- For printer support, see [SGD Command Support on page 1267](#).
- For details on SGD command structure, see [Command Structure on page 635](#).

usb.device.serial_string

Description This command returns the manufacturer-assigned serial number for a particular USB product.

Supported Devices ZT200 Series

Type `getvar`

Commands	Details
<code>getvar</code>	This command returns the printer's serial number. <i>Format:</i> ! U1 <code>getvar "usb.device.serial_string"</code>



Example •

```
! U1 getvar "usb.device.serial_string"
```

Result: "ABC1234567890"



Note •

- For printer support, see [SGD Command Support on page 1267](#).
- For details on SGD command structure, see [Command Structure on page 635](#).

usb.device.vendor_id

Description This command returns the Vendor Identification number that the USB-IF organization has assigned to a manufacturer. This number, along with the Product ID, allows a USB host to distinguish between devices.

Supported Devices ZT200 Series

Type getvar

Commands	Details
getvar	This command retrieves the vendor ID of the device. <i>Format: ! U1 getvar "usb.device.vendor_id"</i>



Example •

```
! U1 getvar "usb.device.vendor_id"
```

Result: "0a5f"



Note •

- For printer support, see [SGD Command Support on page 1267](#).
- For details on SGD command structure, see [Command Structure on page 635](#).

usb.halt

Description This command controls whether the printer allows communication over the USB port when the printer is in an error condition.

Supported Devices ZT200 Series

Type setvar;getvar

Commands	Details
setvar	<p>This command controls whether the printer allows communication over the USB port when the printer is in an error condition.</p> <p><i>Format:</i> ! U1 setvar "usb.halt" "value"</p> <p><i>Values:</i></p> <p style="padding-left: 20px;">"yes"</p> <p style="padding-left: 20px;">"no"</p> <p><i>Default:</i> "no"</p>
getvar	<p>This command returns the current "usb.halt" setting stored in the printer.</p> <p><i>Format:</i> ! U1 getvar "usb.halt"</p>



Example •

```
! U1 setvar "usb.halt" "yes"
```



Note •

- For printer support, see [SGD Command Support on page 1267](#).
- For details on SGD command structure, see [Command Structure on page 635](#).

zbi.control.add_breakpoint

Description This command instructs the printer to set a ZBI program break point. For printer support, see *SGD Command Support* on page 1267.

Type setvar

Commands	Details
setvar	This command instructs the printer to set a ZBI program break point. <i>Format:</i> ! U1 setvar "zbi.control.add_breakpoint" "value" <i>Values:</i> Any line number of the program currently being debugged.



Note • For details on SGD command structure, see *Command Structure* on page 635.



Example • This setvar example shows setting the breakpoint at line "30".

```
! U1 setvar "zbi.control.add_breakpoint" "30"
```

zbi.control.break

Description This command breaks the execution of the ZBI 2.0 program that is currently running. For printer support, see *SGD Command Support* on page 1267.

Type setvar

Commands	Details
setvar	<p>This command breaks the execution of the ZBI program that is currently running.</p> <p><i>Format:</i> ! U1 setvar "zbi.control.break" ""</p> <p><i>Values:</i> ""</p>



Note • For details on SGD command structure, see *Command Structure* on page 635.



Example • This setvar example shows the value set to "".

```
! U1 setvar "zbi.control.break" ""
```

zbi.control.clear_breakpoints

Description This command deletes all breakpoints in the current ZBI 2.0 program. For printer support, see *SGD Command Support on page 1267*.

Type setvar

Commands	Details
setvar	This command instructs the printer to delete all breakpoints. <i>Format:</i> ! U1 setvar "zbi.control.clear_breakpoints" "" <i>Values:</i> ""



Note • For details on SGD command structure, see *Command Structure on page 635*.



Example • This setvar example shows the value set to "".

```
! U1 setvar "zbi.control.clear_breakpoints" ""
```

zbi.control.delete_breakpoint

Description This command deletes a breakpoint in the current ZBI 2.0 program. For printer support, see *SGD Command Support* on page 1267.

Type setvar

Commands	Details
setvar	<p>This command instructs the printer to delete the breakpoint at the line indicated by the value parameter.</p> <p><i>Format:</i> ! U1 setvar "zbi.control.delete_breakpoint" "value"</p> <p><i>Values:</i> you can use the same value as add_breakpoint.</p>



Note • For details on SGD command structure, see *Command Structure* on page 635.



Example • This setvar example shows the breakpoint set to "30".

```
! U1 setvar "zbi.control.delete_breakpoint" "30"
```

zbi.control.line_number

Description This command gives you control and information about which line of a stopped ZBI 2.0 program is being executed. For printer support, see [SGD Command Support on page 1267](#).

Type setvar;setvar

Commands	Details
setvar	This command sets which line of the current ZBI 2.0 program should be executed. <i>Format:</i> ! U1 setvar "zbi.control.line_number" "value" <i>Values:</i> Any line number of the currently stopped ZBI program. <i>Default:</i> "0"
getvar	This command returns the line number that is currently being executed in the ZBI 2.0 program. <i>Format:</i> ! U1 getvar "zbi.control.line_number"



Note • For details on SGD command structure, see [Command Structure on page 635](#).



Example • This `setvar` example shows the value parameter set to "30".

```
! U1 setvar "zbi.control.line_number" "30"
```

When the `setvar` value is set to "30", the `getvar` result is "30".

zbi.control.restart

Description This command restarts a ZBI 2.0 program that is currently stopped. For printer support, see [SGD Command Support on page 1267](#).

Type setvar

Commands	Details
setvar	<p>This command restarts a ZBI 2.0 program that is currently stopped.</p> <p><i>Format:</i> ! U1 setvar "zbi.control.restart" "value"</p> <p><i>Values:</i> ""</p>



Note • For details on SGD command structure, see [Command Structure on page 635](#).



Example • This setvar example shows the value set to "".

```
! U1 setvar "zbi.control.restart" ""
```

zbi.control.run

Description This command runs the current ZBI 2.0 program that is loaded in the interpreter. For printer support, see *SGD Command Support on page 1267*.

Type setvar

Commands	Details
setvar	This command runs the ZBI 2.0 program that is loaded in the interpreter. <i>Format:</i> ! U1 setvar "zbi.control.run" "" <i>Values:</i> ""



Note • For details on SGD command structure, see *Command Structure on page 635*.



Example • This setvar example shows the value set to "".

```
! U1 setvar "zbi.control.run" ""
```

zbi.control.step

Description This command restarts the execution of the currently stopped ZBI 2.0 program for one line. For printer support, see [SGD Command Support on page 1267](#).

Type setvar

Commands	Details
setvar	<p>This command instructs the printer to restart the execution of the currently stopped ZBI 2.0 program for one line.</p> <p><i>Format:</i> ! U1 setvar "zbi.control.step" ""</p> <p><i>Values:</i> ""</p> <p><i>Default:</i> ""</p>



Note • For details on SGD command structure, see [Command Structure on page 635](#).



Example • This `setvar` example shows the value set to "".

```
! U1 setvar "zbi.control.step" ""
```

When the `setvar` value is set to "".

zbi.control.terminate

Description This command instructs the ZBI 2.0 program to terminate and shuts down the interpreter. For printer support, see *SGD Command Support on page 1267*.

Type setvar

Commands	Details
setvar	This command instructs the ZBI 2.0 program to terminate and shuts down the interpreter. <i>Format:</i> ! U1 setvar "zbi.control.terminate" "value" <i>Values:</i> ""



Note • For details on SGD command structure, see *Command Structure on page 635*.



Example • This setvar example shows the value set to "".

```
! U1 setvar "zbi.control.terminate" ""
```

zbi.control.variable_name

Description This command sets the name of the variable that is to be read or modified through `variable_value`. For printer support, see *SGD Command Support on page 1267*.

Type setvar;setvar

Commands	Details
setvar	This command sets the variable that is to show on the front panel. <i>Format:</i> ! U1 setvar "zbi.control.variable_name" "value" <i>Values:</i> Any ZBI variable in the program that is currently being debugged. <i>Default:</i> ""
getvar	This command retrieves the variable value that is to show on the front panel. <i>Format:</i> ! U1 getvar "zbi.control.variable_name"



Note • For details on SGD command structure, see *Command Structure on page 635*.



Example • This `setvar` example shows the value set to "MYVAR\$".

! U1 setvar "zbi.control.variable_name" "MYVAR\$"
 When the `setvar` value is set to "MYVAR\$", the `getvar` result is "MYVAR\$".

zbi.control.variable_value

Description This command identifies the variable name. For printer support, see [SGD Command Support on page 1267](#).

Type setvar;getvar

Commands	Details
setvar	This command sets a value to the variable referenced by a variable_name. <i>Format:</i> ! U1 setvar "zbi.control.variable_value" "value" <i>Values:</i> A string or integer that is dependent on the variable type in variable_name. <i>Default:</i> The current value of the variable referenced via variable_name
getvar	This command retrieves the variable name that is loaded into the variable_name. <i>Format:</i> ! U1 getvar "zbi.control.variable_value"



Note • For details on SGD command structure, see [Command Structure on page 635](#).



Example • This setvar example shows the value set to "Hello World".

```
! U1 setvar "zbi.control.variable_value" "Hello World"
```

When the setvar value is set to "Hello World", the getvar result is "Hello World".

zbi.key

Description This command identifies if the ZBI 2.0 option is enabled or disabled on the printer. For printer support, see *SGD Command Support on page 1267*.

Type `getvar`

Commands	Details
<code>getvar</code>	This command retrieves the status of the ZBI 2.0 option on the printer. <i>Format: ! U1 getvar "zbi.key"</i>



Note • For details on SGD command structure, see *Command Structure on page 635*.



Example • In this example, the `getvar` shows the status of ZBI on the printer.

```
! U1 getvar "zbi.key"
"ENABLED"
```

zbi.last_error

Description This command identifies the last error that the ZBI 2.0 interpreter encountered. For printer support, see [SGD Command Support on page 1267](#).

Type `getvar`

Commands	Details
<code>getvar</code>	This command shows the last error that the ZBI 2.0 interpreter encountered. <i>Format:</i> <code>! U1 getvar "zbi.last_error"</code>



Note • For details on SGD command structure, see [Command Structure on page 635](#).



Example • This example demonstrates how to make the ZBI 2.0 interpreter return the last error it encountered.

```
! U1 getvar "zbi.last_error"
```

zbi.reseller_key

Description This command allows programs that are encrypted with this key in ZBI-Developer to run. For printer support, see [SGD Command Support on page 1267](#).

Type setvar

Commands	Details
setvar	This command allows programs that are encrypted with this key in ZBI developer to run. <i>Format:</i> ! U1 setvar "zbi.reseller_key" "value" <i>Values:</i> Any valid encryption key provided by ZBI Developer.



Note • For details on SGD command structure, see [Command Structure on page 635](#).



Example • This setvar example shows the value set to "abc123".

! U1 setvar "zbi.reseller_key" "abc123".

zbi.revision

Description This command identifies the current ZBI version. For printer support, see [SGD Command Support on page 1267](#).

Type `getvar`

Commands	Details
<code>getvar</code>	This command retrieves the current ZBI version. <i>Format:</i> <code>! U1 getvar "zbi.revision"</code>



Note • For details on SGD command structure, see [Command Structure on page 635](#).



Example • In this example, the `getvar` shows the current ZBI version.

```
! U1 getvar "zbi.revision"
```

zbi.running_program_name

Description This command identifies the name of the ZBI 2.0 program that is currently running. For printer support, see *SGD Command Support on page 1267*.

Type `getvar`

Commands	Details
<code>getvar</code>	This command retrieves the name of the currently running ZBI 2.0 program. <i>Format: ! U1 getvar "zbi.running_program_name"</i>



Note • For details on SGD command structure, see *Command Structure on page 635*.



Example • In this example, the `getvar` command causes the printer to respond that the program `choices.bas` is currently running.

```
! U1 getvar "zbi.running_program_name"
"CHOICES.BAS"
```

zbi.start_info.execute

Description This command instructs the ZBI 2.0 environment to execute the program listed in the `file_name`. For printer support, see *SGD Command Support on page 1267*.

Type `setvar`

Commands	Details
<code>setvar</code>	This command instructs the ZBI 2.0 environment to execute the program listed in the <code>file_name</code> . <i>Format:</i> <code>! U1 setvar "zbi.start_info.execute"</code>



Note • For details on SGD command structure, see *Command Structure on page 635*.



Example • This `setvar` example executes the "`choices.bas`" program.

```
! U1 setvar "zbi.start_info.execute" "choices.bas"
```

zbi.start_info.file_name

Description This command prepares a program to run when the `zbi.start_info.execute` command is used. This command does not run the program. For printer support, see [SGD Command Support on page 1267](#).

Type setvar;getvar

Commands	Details
setvar	<p>This command is used to prepare a ZBI 2.0 program to be executed using the <code>zbi.start_info.execute</code> command.</p> <p><i>Format:</i> ! U1 setvar "zbi.start_info.file_name" "value"</p> <p><i>Values:</i> a file name or path of a basic program</p>
getvar	<p>This command is used to return the file path and file name of a ZBI 2.0 program to run using the <code>zbi.start_info.execute</code> command.</p> <p><i>Format:</i> ! U1 getvar "zbi.start_info.file_name"</p> <p><i>Default:</i> The last program run. If nothing has been run, "*/\ .BAZ".</p>



Note • For details on SGD command structure, see [Command Structure on page 635](#).



Example • This `setvar` example shows the value set to "E:PROGRAM1.BAS".

```
! U1 setvar "zbi.start_info.file_name" "E:PROGRAM1.BAS"
```

When the `setvar` value is set to "E:PROGRAM1.BAS", the `getvar` result is "E:PROGRAM1.BAS".

zbi.start_info.memory_alloc

Description This command identifies the amount of memory currently in use in a ZBI 2.0 program. For printer support, see [SGD Command Support on page 1267](#).

Type `getvar`

Commands	Details
<code>getvar</code>	This command shows the amount of memory currently in use in bytes. <i>Format:</i> <code>! U1 getvar "zbi.start_info.memory_alloc"</code>



Note • For details on SGD command structure, see [Command Structure on page 635](#).



Example • In this example, the `getvar` shows the amount of memory currently in use.

```
! U1 getvar "zbi.start_info.memory_alloc"  
"17203"
```

zbi.state

Description This command shows the current state of the ZBI 2.0 program. For printer support, see [SGD Command Support on page 1267](#).

Type `getvar`

Commands	Details
<code>getvar</code>	<p>This command retrieves the current state of ZBI.</p> <p><i>Format:</i> <code>! U1 getvar "zbi.state"</code></p> <p><i>Values:</i></p> <ul style="list-style-type: none"> <code>"running"</code> = ZBI Interpreter is active and running a program <code>"off"</code> = ZBI Interpreter is inactive <code>"stopped"</code> = ZBI Interpreter is active but not executing a program



Note • For details on SGD command structure, see [Command Structure on page 635](#).



Example • In this example, the `getvar` shows that state of ZBI.

```
! U1 getvar "zbi.state"
"running"
```

zpl.caret

Description This command is used to change the format command prefix for ZPL commands. The default prefix is the caret (^)

This command is equivalent to the ~CC and ^CC ZPL commands.

Supported Devices ZT200 Series

Type setvar;getvar

Commands	Details
setvar	This command sets the command prefix. <i>Format:</i> ! U1 setvar "zpl.caret" "value" <i>Values:</i> any ASCII character <i>Default:</i> "^"
getvar	This command retrieves the current format command prefix. <i>Format:</i> ! U1 getvar "zpl.caret"



Example • This `setvar` example changes the format prefix to a forward slash "/"

```
! U1 setvar "zpl.caret" "/"
```



Note •

- For printer support, see [SGD Command Support on page 1267](#).
- For details on SGD command structure, see [Command Structure on page 635](#).

zpl.control_character

Description This command is used to change the control command prefix. The default prefix is the tilde (~).

This command is equivalent to the ^CT and ~CT commands.

Supported Devices ZT200 Series

Type setvar;getvar

Commands	Details
setvar	<p>This command changes the control character.</p> <p><i>Format:</i> ! U1 setvar "zpl.control_character" "value"</p> <p><i>Values:</i> ASCII values for the desired character "00-FF,00-ff,up,down"</p> <p>See ASCII Code Chart on page 1208.</p> <p><i>Default:</i> "7E" (tilde)</p>
getvar	<p>This command returns the currently set control character.</p> <p><i>Format:</i> ! U1 getvar "zpl.control_character"</p>



Example • This example sets the value set to "+".

```
! U1 setvar "zpl.control_characater" "2b"
```



Note •

- For printer support, see [SGD Command Support on page 1267](#).
- For details on SGD command structure, see [Command Structure on page 635](#).

zpl.delimiter

Description This command is used to change the delimiter character for ZPL commands. The default delimiter character is the comma (,).

Related Commands: ^CD and ~CD commands.

Supported Devices ZT200 Series

Type setvar;getvar

Commands	Details
setvar	This command changes the delimiter character for ZPL commands. <i>Format:</i> ! U1 setvar "zpl.delimiter" "value" <i>Values:</i> HEX values for the desired character "00-FF,00-ff,up,down" See ASCII Code Chart on page 1208 . <i>Default:</i> "2C" (comma)
getvar	This command returns the currently set delimiter character. <i>Format:</i> ! U1 getvar "zpl.delimiter"



Example • This example changes the delimiter to a semi-colon (;).

```
! U1 setvar "zpl.delimiter" "3B"
```



Note •

- For printer support, see [SGD Command Support on page 1267](#).
- For details on SGD command structure, see [Command Structure on page 635](#).

zpl.label_length

Description This command defines the length of the label. This command is necessary when using continuous media (media that is not divided into separate labels by gaps, spaces, notches, slots, or holes).

This command is equivalent to the ^LL command.

Supported Devices ZT200 Series

Type setvar;getvar

Commands	Details
setvar	<p>This command sets the label length.</p> <p><i>Format:</i> ! U1 setvar "zpl.label_length" "value"</p> <p><i>Values:</i> 1 to 32000, (in dots) not to exceed the maximum label length. While the printer accepts any value for this parameter, the amount of memory installed determines the maximum length of the label.</p>
getvar	<p>This command returns the current label length setting.</p> <p><i>Format:</i> ! U1 getvar "zpl.label_length"</p>

Comments These formulas can be used to determine the value of *y*:

For 6 dot/mm printheads...	Label length in inches x 152.4 (dots/inch) = <i>y</i>
For 8 dot/mm printheads...	Label length in inches x 203.2 (dots/inch) = <i>y</i>
For 12 dot/mm printheads...	Label length in inches x 304.8 (dots/inch) = <i>y</i>
For 24 dot/mm printheads...	Label length in inches x 609.6 (dots/inch) = <i>y</i>

Values for *y* depend on the memory size. If the entered value for *y* exceeds the acceptable limits, the bottom of the label is cut off. The label also shifts down from top to bottom.



Example •

```
! U1 setvar zpl.label_length "1281"
```



Note •

- For printer support, see [SGD Command Support on page 1267](#).
- For details on SGD command structure, see [Command Structure on page 635](#).

zpl.left_position

Description This command sets the label's left margin offset in dots.

Related Command: ^LS

Supported Devices ZT200 Series

Type setvar;getvar

Commands	Details
setvar	This command sets the label left margin offset in dots. <i>Format:</i> ! U1 setvar "zpl.left_position" "value" <i>Values:</i> "-9999 to 9999" <i>Default:</i> "0"
getvar	This command retrieves the currently set left margin offset for the label. <i>Format:</i> ! U1 getvar "zpl.left_position"



Example •

```
! U1 setvar "zpl.left_position" "100"
```



Note •

- For printer support, see [SGD Command Support on page 1267](#).
- For details on SGD command structure, see [Command Structure on page 635](#).

zpl.system_error

Description This command returns the system error flags.

This command is equivalent to the error recording of ~HQES

Supported Devices ZT200 Series

Type getvar

Commands	Details
getvar	This command returns the state of the system error flags.. <i>Format:</i> ! U1 getvar "zpl.system_error" <i>Result:</i> 0,0,00000000,00000000 (flag, error flag, Group 2, Group 1)



Example 1 • This example shows how to request the printer's status.

To request the printer's status, type ! U1 getvar "zpl.system_error"

The printer responds with data similar to this: "1,1,00000000,00000004"

In this example, the Printer Status resolves to these conditions:

- The printer is in Pause (value = 1)
- The Error Flag is 0 if there are no errors (i.e. Group 2 and Group 1 are all 0s), and 1 if there are any errors.
- The cover/printhead is open (value = 4).

Table 27 • Error Flags (~HQES)

Error Flags	Flag	Group 2	Group 1 (X = Value can be any hexadecimal number [0-9, A-F])							
		Nibbles16 -9	Nibble 8	Nibble 7	Nibble 6	Nibble 5	Nibble 4	Nibble 3	Nibble 2	Nibble 1
No Error	0	00000000	0	0	0	0	0	0	0	0
Error Present	1	00000000	X	X	X	X	X	X	X	X
Printhead Thermistor Open	1	00000000	X	X	X	X	X	2	X	X
Invalid Firmware Config.	1	00000000	X	X	X	X	X	1	X	X
Printhead Detection Error	1	00000000	X	X	X	X	X	X	8	X
Bad Printhead Element	1	00000000	X	X	X	X	X	X	4	X
Motor Over Temperature	1	00000000	X	X	X	X	X	X	2	X
Printhead Over Temperature	1	00000000	X	X	X	X	X	X	1	X
Cutter Fault	1	00000000	X	X	X	X	X	X	X	8
Head Open	1	00000000	X	X	X	X	X	X	X	4
Ribbon Out	1	00000000	X	X	X	X	X	X	X	2
Media Out	1	00000000	X	X	X	X	X	X	X	1
Clear Paper Path Failed ^a	1 ^a	00000000	X	X	X	X	8 ^a	X	X	X

a. This error flag is supported only on KR403 printers.

Table 27 • Error Flags (~HQES)

Error Flags	Flag	Group 2	Group 1 (X = Value can be any hexadecimal number [0-9, A-F])							
		Nibbles16 -9	Nibble 8	Nibble 7	Nibble 6	Nibble 5	Nibble 4	Nibble 3	Nibble 2	Nibble 1
Paper Feed Error ^a	1 ^a	00000000	X	X	X	X	4 ^a	X	X	X
Presenter Not Running ^a	1 ^a	00000000	X	X	X	X	2 ^a	X	X	X
Paper Jam during Retract ^a	1 ^a	00000000	X	X	X	X	1 ^a	X	X	X
Black Mark not Found ^a	1 ^a	00000000	X	X	X	8 ^a	X	X	X	X
Black Mark Calabrate Error ^a	1 ^a	00000000	X	X	X	4 ^a	X	X	X	X
Retract Function timed out ^a	1 ^a	00000000	X	X	X	2 ^a	X	X	X	X
Paused ^a	1 ^a	00000000	X	X	X	1 ^a	X	X	X	X

a. This error flag is supported only on KR403 printers.



Note •

- For printer support, see *SGD Command Support* on page 1267.
- For details on SGD command structure, see *Command Structure* on page 635.

zpl.system_status

Description This command returns the errors and warnings of the system.

This command is equivalent to all data reported by the ~HQES ZPL command.

Supported Devices ZT200 Series

Type getvar

Commands	Details
getvar	<p>This command returns the system error and warning flags.</p> <p><i>Format:</i> ! U1 getvar "zpl.system_status"</p> <p><i>Result:</i> 0,0,00000000,00000000,0,00000000,00000000 (flag, error flag, group 2, group 1, warning flag, group 2, group 1)</p>



Example 1 • This example shows how to request the printer’s status.

a. To request the printer’s status, type ! U1 getvar "zpl.system_status"

The printer responds with data similar to this:

"1,1,00000000,00000004,0,00000000,00000000"

In this example, the Printer Status resolves to these conditions:

- The printer is in Pause (value = 1)
- The Error Flag is 0 if there are no errors (i.e. Group 2 and Group 1 are all 0s), and 1 if there are any errors (non-zero).
- The cover/printhead is open (value = 4).
- The Warning Flag is 0 if there are no warnings (i.e. Group 2 and Group 1 are all 0s), and 1 if there are any errors (non-zero).

Table 28 • Error Flags (~HQES)

Error Flags	Flag	Group 2	Group 1 (X = Value can be any hexadecimal number [0-9, A-F])							
		Nibbles16 -9	Nibble 8	Nibble 7	Nibble 6	Nibble 5	Nibble 4	Nibble 3	Nibble 2	Nibble 1
No Error	0	00000000	0	0	0	0	0	0	0	0
Error Present	1	00000000	X	X	X	X	X	X	X	X
Printhead Thermistor Open	1	00000000	X	X	X	X	X	2	X	X
Invalid Firmware Config.	1	00000000	X	X	X	X	X	1	X	X
Printhead Detection Error	1	00000000	X	X	X	X	X	X	8	X
Bad Printhead Element	1	00000000	X	X	X	X	X	X	4	X
Motor Over Temperature	1	00000000	X	X	X	X	X	X	2	X
Printhead Over Temperature	1	00000000	X	X	X	X	X	X	1	X
Cutter Fault	1	00000000	X	X	X	X	X	X	X	8
Head Open	1	00000000	X	X	X	X	X	X	X	4

a. This error flag is supported only on KR403 printers.

Table 28 • Error Flags (~HQES)

Error Flags	Flag	Group 2	Group 1 (X = Value can be any hexadecimal number [0-9, A-F])							
		Nibbles16 -9	Nibble 8	Nibble 7	Nibble 6	Nibble 5	Nibble 4	Nibble 3	Nibble 2	Nibble 1
Ribbon Out	1	00000000	X	X	X	X	X	X	X	2
Media Out	1	00000000	X	X	X	X	X	X	X	1
Clear Paper Path Failed ^a	1 ^a	00000000	X	X	X	X	8 ^a	X	X	X
Paper Feed Error ^a	1 ^a	00000000	X	X	X	X	4 ^a	X	X	X
Presenter Not Running ^a	1 ^a	00000000	X	X	X	X	2 ^a	X	X	X
Paper Jam during Retract ^a	1 ^a	00000000	X	X	X	X	1 ^a	X	X	X
Black Mark not Found ^a	1 ^a	00000000	X	X	X	8 ^a	X	X	X	X
Black Mark Calabrate Error ^a	1 ^a	00000000	X	X	X	4 ^a	X	X	X	X
Retract Function timed out ^a	1 ^a	00000000	X	X	X	2 ^a	X	X	X	X
Paused ^a	1 ^a	00000000	X	X	X	1 ^a	X	X	X	X

a. This error flag is supported only on KR403 printers.

Table 29 • Warning Flags (~HQES)

Error Flags	Flag	Group 2	Group 1 (X = Value can be any hexadecimal number [0-9, A-F])							
		Nibbles16 -9	Nibble 8	Nibble 7	Nibble 6	Nibble 5	Nibble 4	Nibble 3	Nibble 2	Nibble 1
No Warning	0	00000000	0	0	0	0	0	0	0	0
Warning Present	1	00000000	X	X	X	X	X	X	X	X
Paper-near-end Sensor ^b	1 ^b	00000000	X	X	X	X	X	X	X	8 ^b
Replace Printhead	1	00000000	X	X	X	X	X	X	X	4
Clean Printhead	1	00000000	X	X	X	X	X	X	X	2
Need to Calibrate Media	1	00000000	X	X	X	X	X	X	X	1
Sensor 1 (Paper before head) ^b	1 ^b	00000000	X	X	X	X	X	X	1 ^b	X
Sensor 2 (Black mark) ^b	1 ^b	00000000	X	X	X	X	X	X	2 ^b	X
Sensor 3 (Paper after head) ^b	1 ^b	00000000	X	X	X	X	X	X	4 ^b	X
Sensor 4 (loop ready) ^b	1 ^b	00000000	X	X	X	X	X	X	8 ^b	X
Sensor 5 (presenter) ^b	1 ^b	00000000	X	X	X	X	X	1 ^b	X	X
Sensor 6 (retract ready) ^b	1 ^b	00000000	X	X	X	X	X	2 ^b	X	X
Sensor 7 (in retract) ^b	1 ^b	00000000	X	X	X	X	X	4 ^b	X	X
Sensor 8 (at bin) ^b	1 ^b	00000000	X	X	X	X	X	8 ^b	X	X

b. This error flag is supported only on KR403 printers.



Note •

- For printer support, see [SGD Command Support on page 1267](#).
- For details on SGD command structure, see [Command Structure on page 635](#).

zpl.zpl_mode

Description This command sets the ZPL mode to ZPL II or ZPL.

Supported Devices ZT200 Series

Type setvar;setvar

Commands	Details
setvar	<p>This command sets the printer ZPL mode.</p> <p><i>Format:</i> ! U1 setvar "zpl.zpl_mode" "value"</p> <p><i>Values:</i></p> <p>"zpl"</p> <p>"zpl II"</p> <p><i>Default:</i> "zpl II"</p>
getvar	<p>This command returns the current ZPL mode setting.</p> <p><i>Format:</i> ! U1 getvar "zpl.zpl_mode"</p>



Example • This `setvar` example sets the ZPL mode to ZPL.

```
! U1 setvar "zpl.system_status" "zpl"
```



Note •

- For printer support, see [SGD Command Support on page 1267](#).
- For details on SGD command structure, see [Command Structure on page 635](#).

zpl.zpl_override

Description Enable this menu item to prevent the following ZPL commands from changing the printer's current settings:

- `^MM` (print mode)
- `^MT` (Direct Thermal or Thermal Transfer print method)
- `^MN` (media type - non-continuous or continuous)

When this menu item is disabled, these commands override the printer's settings.

Supported Devices ZT200 Series

Type `setvar;getvar`

Commands	Details
<code>setvar</code>	<p>Sets the override status to the specified value.</p> <p><i>Format:</i> <code>! U1 setvar "zpl.zpl_override" "value"</code></p> <p><i>Values:</i></p> <ul style="list-style-type: none"> <code>"disabled"</code> = allows override <code>"enabled"</code> = prevents ZPL commands from overriding printer settings. <p><i>Default:</i> <code>"disabled"</code></p>
<code>getvar</code>	<p>Returns the current override status.</p> <p><i>Format:</i> <code>! U1 getvar "zpl.zpl_override"</code></p> <p><i>Values:</i></p> <ul style="list-style-type: none"> <code>"disabled"</code> <code>"enabled"</code>



Example • This example enables `zpl.zpl_override`, which prevents `^MM`, `^MT`, and `^MN` from making changes to the current printer settings.

```
! U1 setvar "zpl.zpl_override" "enabled"
```



Note •

- For printer support, see [SGD Command Support on page 1267](#).
- For details on SGD command structure, see [Command Structure on page 635](#).

SGD Wired Commands

This chapter provides a high-level overview of the wired Set / Get / Do (SGD) commands. For printer support of these SGD commands, see [SGD Command Support on page 1267](#).



SGD commands are available in printers with the following firmware versions or later:

- V60.16.2Z or later
- V60.15.xZ or later
- V50.15.xZ or later
- V61.15.xZ or later
- V56.15.xZ or later
- V53.16.x or later
- V53.15.2Z or later
- R53.16.3Z or later
- R60.15.8Z or later
- R62.15.8Z or later
- R63.15.8Z or later
- R65.15.8Z or later



Important • These are important points to note when using ZPL and SGD commands:

- SGD commands are case-sensitive.
- ZPL and SGD commands should be sent to the printer as separate files.
- Certain settings can be controlled by both ZPL and SGD. Configuration changes made in ZPL can affect configuration changes made in SGD.
- Changes made with one command type (ZPL or SGD) will affect the data returned to the host in response to both ZPL and getvar commands. The command type (ZPL or SGD) that was sent last determines the current setting.
- Some RF cards do not support all of the SGD commands.



Important • These are important points to note when using a Zebra G-Series printer:

- You can send instructions to the printer using multiple programming languages: EPL, ZPL, or SGD. EPL and ZPL commands configure the printer, print labels, and get device status information. SGD commands set and get configuration details. These three languages can be used without the need to send the printer instructions to switch from one language to another.
- EPL, ZPL, and SGD commands must be sent to the printer as separate files. They cannot be used together in one format, or set of commands. For example, if you send a series of SGD commands to the printer and they are followed by a printable format, this needs to be done using separate files.

Overview

This section describes how and why to use the Set / Get / Do (SGD) commands. It also provides an example of a typical command structure.



Note • SGD commands must be terminated by a carriage return or a space and line feed.

SGD commands are commands that allow you to configure all printers with firmware version V60.15.x, V50.15.x, V61.15.x, V56.15.x, V53.15.xZ, or later. The printer performs the specified function immediately after receiving the command. The commands are:

- **setvar**
- **getvar**
- **do**

setvar Command

Setvar commands:

- are used to configure printer settings to specific values by setting them in the printer
- must be terminated by a space character or a CR/ LF (0x0D, 0x0A)



Important • The setvar command and attributes must be specified in lower case.

getvar Command

Getvar commands:

- are used to get the current value of the printer settings
- must be terminated by a space character or CR/LF (0x0D, 0x0A)

The printer responds with the printer setting of “?” if:

- the printer setting does not exist (usually due to incorrect spelling of the printer setting)
- it has not been configured yet



Important • The printer settings and attributes must be specified in lower case.

do Command

Do commands:

- are used to instruct the printer to perform predefined actions
- must be terminated by a space character or a CR/LF (0x0D, 0x0A)

Some Do commands require additional settings which must be enclosed in double quotes.



Important • The values must be specified in lower case.

Command Structure

It is important to understand the structure of the command and its components. A command structure illustration is provided for each command in this guide.

→ **Example** • This is an example of a command structure illustration:

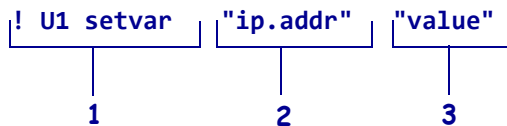

1	Command—always preceded with an exclamation point (!) and must be specified in lower case. A space resides between the ! and U1 and between U1 and the command (setvar or getvar).
2	Attribute—always in double quotes and must be specified in lower case.
3	Chosen value—always in double quotes. Only applicable for setvar and do .

This command must be terminated by a space character or a CR/ LF (0x0D, 0x0A).

How to Send Multiple SGD Commands

For any **getvar**, **setvar**, or **do** command, if you issue the syntax without the "1" and use the END command followed by a space, multiple SGD commands are sent simultaneously.

→ **Example** • This syntax shows how you can send multiple **getvar** commands:

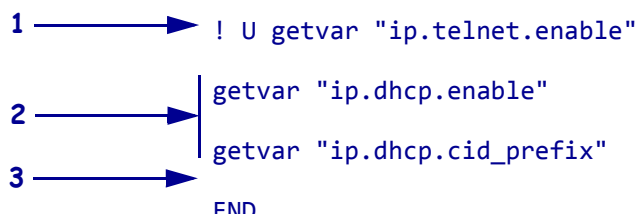

1	The command portion of the string does not use the "1" after the "! U".
2	Commands issued after the first command do not require the "! U".
3	The string of commands is terminated by the word "END" with a space after the word, and by a carriage return/ line feed.

external_wired.check

Description This command controls whether to check for external print server during the network interface search.

Type setvar;getvar

Commands	Details
setvar	<p>This command instructs the printer to set the network interface search.</p> <p><i>Format:</i> ! U1 setvar "external_wired.check" "value"</p> <p><i>Values:</i></p> <ul style="list-style-type: none"> "on" = turn on external wired network interface search "off" = turn off external wired network interface search <p><i>Default:</i></p> <ul style="list-style-type: none"> "on" = If wireless option board is not installed "off" = If wireless option board is installed
getvar	<p>This command retrieves the status of the network interface search.</p> <p><i>Format:</i> ! U1 getvar "external_wired.check"</p>



Example • This setvar example shows the value set to "off".

```
! U1 setvar "external_wired.check" "off"
```

When the setvar value is set to "off", the getvar result is "off".



Note •

- For printer support, see [SGD Command Support on page 1267](#).
- For details on SGD command structure, see [Command Structure on page 635](#).

external_wired.ip.addr

Description This command allows you to get or set the external wired print servers's IP address.



Important • For a set IP address to take affect, the IP protocol must be set to permanent and the print server must be reset.

Type setvar;getvar

Commands	Details
setvar	This command instructs the printer to change its current external wired print server IP address upon powering the printer on. <i>Format:</i> ! U1 setvar "external_wired.ip.addr" "value" <i>Values:</i> any valid IP address <i>Default:</i> "0.0.0.0"
getvar *	This command instructs the printer to respond with its current external wired print server IP address. <i>Format:</i> ! U1 getvar "external_wired.ip.addr"

* On SEH print server models PS102-Z or the PS105-Z, only the getvar command is supported.



Note • The setvar value of this command can be affected by the external_wired.ip.dhcp.enable command.



Example • This setvar example shows the value set to "10.14.4.235".

```
! U1 setvar "external_wired.ip.addr" "10.14.4.235"
```

What the setvar value is set to is the getvar result. In this example, the getvar result is "10.14.4.235".



Note •

- For printer support, see [SGD Command Support on page 1267](#).
- For details on SGD command structure, see [Command Structure on page 635](#).

external_wired.ip.arp_interval

Description This print server setting allows you to specify the ARP (Address Resolution Protocol) interval or the ARP cache time out for the external wired print server.

Type setvar;setvar

Commands	Details
setvar	This command instructs the printer to change the ARP interval or the ARP cache time out for the external wired print server. <i>Format:</i> ! U1 setvar "external_wired.ip.arp_interval" "value" <i>Values:</i> 0 - 30 <i>Default:</i> "0"
getvar *	This command instructs the printer to respond with the ARP interval or the ARP cache time out value for the external wired print server. <i>Format:</i> ! U1 getvar "external_wired.ip.arp_interval"

* On SEH print server models PS102-Z or the PS105-Z, only the getvar command is supported.



Example • This `setvar` example shows the value set to "0".

```
! U1 setvar "external_wired.ip.arp_interval" "0"
```

What the `setvar` value is set to is the `getvar` result. In this example, the `getvar` result is "0".



Note •

- For printer support, see [SGD Command Support on page 1267](#).
- For details on SGD command structure, see [Command Structure on page 635](#).

external_wired.ip.default_addr_enable

Description This command allows you to default the external wired print server's IP address.



Important • For a set IP address to take affect, the IP protocol must be set to permanent and the print server must be reset.

Type setvar;getvar

Commands	Details
setvar	<p>This command tells the printer to use it's default address, if no address is provided through DHCP or BOOTP. If you do not assign an IP address after 2 minutes, the 10/100 Internal PS defaults to IP address 192.168.254.254.</p> <p><i>Format:</i> ! U1 setvar "external_wired.ip.default_addr_enable" "value"</p> <p><i>Values:</i> "on" = enabled "off" = disabled</p> <p><i>Default:</i> "on"</p>
getvar *	<p>This command instructs the printer to show the status of the setting of external wired print server's default IP address feature.</p> <p><i>Format:</i> ! U1 getvar "external_wired.ip.default_addr_enable"</p>

* On SEH print server models PS102-Z or the PS105-Z, only the getvar command is supported.



Example • This setvar example shows the value set to "on".

```
! U1 setvar "external_wired.ip.default_addr_enable" "on"
```

What the setvar value is set to is the getvar result. In this example, the getvar result is "on".



Note •

- For printer support, see [SGD Command Support on page 1267](#).
- For details on SGD command structure, see [Command Structure on page 635](#).

external_wired.ip.dhcp.cid_all

Description This printer setting defines the entire client identifier (DHCP option 61) if DHCP is enabled on the external print server and "external_wired.ip.dhcp.cid_type" is set to "0", or "2". The MAC address is used if the type is set to "1".

Type setvar;getvar

Commands	Details
setvar	<p>This command instructs the printer to change the client identifier prefix and suffix of the external wired print server. The prefix gets cleared and the suffix contains the entire client identifier.</p> <p><i>Format:</i> ! U1 setvar "external_wired.ip.dhcp.cid_all" "value"</p> <p><i>Values:</i> A maximum length of 60 characters if the CID type is ASCII, or 120 characters if the CID type is hexadecimal.</p> <p><i>Default Value:</i> ""</p>
getvar *	<p>This command instructs the printer to respond with the client identifier prefix and suffix of the external wired print server.</p> <p><i>Format:</i> ! U1 getvar "external_wired.ip.dhcp.cid_all"</p>

* On SEH print server models PS102-Z or the PS105-Z, only the getvar command is supported.



Example • This `setvar` example shows the value set to "printer".

```
! U1 setvar "external_wired.ip.dhcp.cid_all" "printer"
```

What the `setvar` value is set to is the `getvar` result. In this example, the `getvar` result is "printer".



Note •

- For printer support, see [SGD Command Support on page 1267](#).
- For details on SGD command structure, see [Command Structure on page 635](#).

external_wired.ip.dhcp.cid_enable

Description This command determines if DHCP (option 61) on the external wired print server is turned on or off.

Type setvar;setvar

Commands	Details
setvar	<p>This command instructs the printer to set the status of the client identifier of the external wired print server.</p> <p><i>Format:</i> ! U1 setvar "external_wired.ip.dhcp.cid_enable" "value"</p> <p><i>Values:</i></p> <ul style="list-style-type: none">"off" = client identifier is turned off"on" = client identifier is turned on <p><i>Default:</i> "off"</p>
getvar *	<p>This command instructs the printer to respond with the status of the client identifier of the external wired print server.</p> <p><i>Format:</i> ! U1 getvar "external_wired.ip.dhcp.cid_enable"</p>

* On SEH print server models PS102-Z or the PS105-Z, only the getvar command is supported.



Example • This setvar example shows the value set to "off".

```
! U1 setvar "external_wired.ip.dhcp.cid_enable" "off"
```

What the setvar value is set to is the getvar result. In this example, the getvar result is "off".



Note •

- For printer support, see [SGD Command Support on page 1267](#).
- For details on SGD command structure, see [Command Structure on page 635](#).

external_wired.ip.dhcp.cid_prefix

Description This printer setting defines the prefix to be prepended to the DHCP client identifier (option 61) when DHCP is enabled on the external wired print server and "external_wired.ip.dhcp.cid_type" is set to "0" or "2".

Type setvar;getvar

Commands	Details
setvar	This command instructs the printer to change the CID prefix of the external wired print server. <i>Format:</i> ! U1 setvar "external_wired.ip.dhcp.cid_prefix" "value" <i>Values:</i> Any text string up to 10 characters if the CID type is ASCII, or 20 characters if the CID type is hexadecimal. <i>Default Value:</i> ""
getvar *	This command instructs the printer to respond with the client identifier prefix of the external wired print server. <i>Format:</i> ! U1 getvar "external_wired.ip.dhcp.cid_prefix"

* On SEH print server models PS102-Z or the PS105-Z, only the getvar command is supported.



Example • This `setvar` example shows the value set to "PRT001".

```
! U1 setvar "external_wired.ip.dhcp.cid_prefix" "PRT001"
```

What the `setvar` value is set to is the `getvar` result. In this example, the `getvar` result is "PRT001".



Note •

- For printer support, see [SGD Command Support on page 1267](#).
- For details on SGD command structure, see [Command Structure on page 635](#).

external_wired.ip.dhcp.cid_suffix

Description This printer setting defines the unique suffix to be used as the client identifier (DHCP option 61) if DHCP is enabled repeated on the external wired print server and [external_wired.ip.dhcp.cid_type](#) on page 923 is set to "0" or "2", not "1".

Type setvar;getvar

Commands	Details
setvar	This command instructs the printer to change the client identifier suffix value. <i>Format:</i> ! U1 setvar "external_wired.ip.dhcp.cid_suffix" "value" <i>Values:</i> The maximum length of a value allowed is 60 ASCII characters when the CID type is ASCII, or 120 hexadecimal values when the CID type is hexadecimal. <i>Default:</i> ""
getvar *	This command instructs the printer to respond with the client identifier suffix on the external wired print server. <i>Format:</i> ! U1 getvar "external_wired.ip.dhcp.cid_suffix"

* On SEH print server models PS102-Z or the PS105-Z, only the getvar command is supported.



Example • This `setvar` example shows setting the suffix to "printer".

```
! U1 setvar "external_wired.ip.dhcp.cid_suffix" "printer"
```

What the `setvar` value is set to is the `getvar` result. In this example, the `getvar` result is "printer".



Note •

- For printer support, see [SGD Command Support on page 1267](#).
- For details on SGD command structure, see [Command Structure on page 635](#).

external_wired.ip.dhcp.cid_type

Description This printer setting defines the type of client identifier (DHCP option 61) that will be sent if DHCP is enabled on the external wired print server. A value of "1" means the type of "Ethernet" and the printer's MAC address will be used. A value of "0" or "2" means the client identifier sent will be "external_wired.ip.dhcp.cid_prefix" concatenated with "external_wired.ip.dhcp.cid_suffix".

Type setvar;setvar

Commands	Details
setvar	<p>This command instructs the printer to enable "synthetic" Client Identifier for the external wired print server.</p> <p><i>Format:</i> ! U1 setvar "external_wired.ip.dhcp.cid_type" "value"</p> <p><i>Values:</i></p> <ul style="list-style-type: none"> "0" = ASCII string "1" = wired print server's MAC address "2" = HEX value <p><i>Default Value:</i> "1"</p>
getvar *	<p>This command instructs the printer to respond with the client identifier type for the external wired print server.</p> <p><i>Format:</i> ! U1 getvar "external_wired.ip.dhcp.cid_type"</p>

* On SEH print server models PS102-Z or the PS105-Z, only the getvar command is supported.



Example • This `setvar` example shows the value set to "1".

```
! U1 setvar "external_wired.ip.dhcp.cid_type" "1"
```

When the `setvar` value is set to "1", the `getvar` result is "1".



Note •

- For printer support, see [SGD Command Support on page 1267](#).
- For details on SGD command structure, see [Command Structure on page 635](#).

external_wired.ip.gateway

Description This command instructs the printer to change the external wired print server's gateway address.



Important • This setting refers to the gateway address. A set value is ignored if the IP protocol is not set to permanent.

Type setvar;getvar

Commands	Details
setvar	This command instructs the printer to change the external wired printer server's gateway address. <i>Format:</i> ! U1 setvar "external_wired.ip.gateway" "value" <i>Values:</i> Any valid gateway address <i>Default:</i> "0.0.0.0"
getvar *	This command instructs the printer to respond with the external wired printer server's gateway address. <i>Format:</i> ! U1 getvar "external_wired.ip.gateway"

* On SEH print server models PS102-Z or the PS105-Z, only the getvar command is supported.



Example • This setvar example shows the value set to "10.3.5.1".

```
! U1 setvar "external_wired.ip.gateway" "10.3.5.1"
```

When the setvar value is set to "10.3.5.1", the getvar result is "10.3.5.1".



Note •

- For printer support, see [SGD Command Support on page 1267](#).
- For details on SGD command structure, see [Command Structure on page 635](#).

external_wired.ip.netmask

Description This setting refers to the external wired print server's subnet mask address. This value is ignored if the IP protocol is not set to permanent.

Type setvar;setvar

Commands	Details
setvar	This command instructs the printer to change the external wired print servers's subnet mask. <i>Format:</i> ! U1 setvar "external_wired.ip.netmask" "value" <i>Values:</i> Any valid subnet mask. <i>Default:</i> "255.255.255.0"
getvar *	This command instructs the printer to respond with the external wired print server's subnet mask. <i>Format:</i> ! U1 getvar "external_wired.ip.netmask"

* On SEH print server models PS102-Z or the PS105-Z, only the getvar command is supported.



Example • This `setvar` example shows the value set to "255.255.255.0".

```
! U1 setvar "external_wired.ip.netmask" "255.255.255.0"
```

When the `setvar` value is set to "255.255.255.0", the `getvar` result is "255.255.255.0".



Note •

- For printer support, see [SGD Command Support on page 1267](#).
- For details on SGD command structure, see [Command Structure on page 635](#).

external_wired.ip.port

Description This printer setting refers to the external wired print server's port number that the TCP print service is listening on. Normal TCP communications from the host should be directed to this port.

Type setvar;getvar

Commands	Details
setvar	This command instructs the printer to set the external wired print server's TCP/UDP port number. <i>Format:</i> ! U1 setvar "external_wired.ip.port" "value" <i>Values:</i> 1 - 65535 (excluding any ports currently used by other services, such as 21, 23, 80, and 515). <i>Default:</i> "9100"
getvar *	This command instructs the printer to respond with the external wired printer server's TCP/UDP port number. <i>Format:</i> ! U1 getvar "external_wired.ip.port"

* On SEH print server models PS102-Z or the PS105-Z, only the getvar command is supported.



Example • This setvar example shows the value set to "9100".

```
! U1 setvar "external_wired.ip.port" "9100"
```

When the setvar value is set to "9100", the getvar result is "9100".



Note •

- For printer support, see [SGD Command Support on page 1267](#).
- For details on SGD command structure, see [Command Structure on page 635](#).

external_wired.ip.protocol

Description This command configures the IP addressing method used by the external wired print server.

Type setvar;getvar

Commands	Details
setvar	<p>This command instructs the printer to configure the IP addressing method used by the external wired print server.</p> <p><i>Format:</i> ! U1 setvar "external_wired.ip.protocol" "value"</p> <p><i>Values:</i></p> <ul style="list-style-type: none"> "bootp" = uses the standard bootp addressing method to obtain an IP address and configuration "dhcp" = uses the standard dhcp addressing method to obtain an IP address and configuration for a server specified period of time "rarp" = uses the standard rarp addressing method to obtain an IP address "glean" = uses the IP address from a PING packet that is sent to its hardware address (unicast address) "permanent" = uses static values assigned through other commands "all" = tries all of the dynamic addressing methods, not permanent, to obtain an IP address <p><i>Default:</i> "all"</p>
getvar *	<p>This command returns the IP addressing method used by the external print server.</p> <p><i>Format:</i> ! U1 getvar "external_wired.ip.protocol"</p>

* On SEH print server models PS102-Z or the PS105-Z, only the getvar command is supported.



Example • In this example, the `setvar` result is the current programming language that the printer is using.

```
! U1 setvar "external_wired.ip.protocol" "bootp"
```

What the `setvar` value is set to is the `getvar` result. In this example, the `getvar` result is "bootp".



Note •

- For printer support, see [SGD Command Support on page 1267](#).
- For details on SGD command structure, see [Command Structure on page 635](#).

external_wired.ip.timeout.enable

Description This network setting refers to enabling the connection timeout on the external wired 10/100 print server. For this to take effect, the print server must be reset.

Type setvar;setvar

Commands	Details
setvar	<p>This command instructs the printer to enable or disable the timeout checking on the external wired print server.</p> <p><i>Format:</i></p> <pre>! U1 setvar "external_wired.ip.timeout.enable" "value"</pre> <p><i>Values:</i></p> <ul style="list-style-type: none"> "off" = turns off the connection checking "on" = turns on the connection checking <p><i>Default:</i> "on"</p>
getvar *	<p>This command instructs the printer to return whether the timeout checking is enabled on the external wired print server.</p> <p><i>Format:</i></p> <pre>! U1 getvar "external_wired.ip.timeout.enable"</pre>

* On SEH print server models PS102-Z or the PS105-Z, only the getvar command is supported.



Example • This setvar example shows the value set to "on".

```
! U1 setvar "external_wired.ip.timeout.enable" "on"
```

When the setvar value is set to "on", the getvar result is "on".



Note •

- For printer support, see [SGD Command Support on page 1267](#).
- For details on SGD command structure, see [Command Structure on page 635](#).

external_wired.ip.timeout.value

Description This network setting refers to the number of seconds before the connection times out for the external wired print server.

Type setvar;getvar

Commands	Details
setvar	<p>This command instructs the printer to set the time of the external wired print server, in seconds, before the connection times out.</p> <p><i>Format:</i> ! U1 setvar "external_wired.ip.timeout.value" "value"</p> <p><i>Values:</i> "1" through "3600"</p> <p><i>Default:</i> "300"</p>
getvar *	<p>This command instructs the printer to respond with the time of the external wired print server, in seconds, before the connection times out.</p> <p><i>Format:</i> ! U1 getvar "external_wired.ip.timeout.value"</p>

* On SEH print server models PS102-Z or the PS105-Z, only the getvar command is supported.



Example • This `setvar` example shows the value set to "300".

```
! U1 setvar "external_wired.ip.timeout.value" "300"
```

When the `setvar` value is set to "300", the `getvar` result is "300".



Note •

- For printer support, see [SGD Command Support on page 1267](#).
- For details on SGD command structure, see [Command Structure on page 635](#).

external_wired.ip.v6.addr

Description This command retrieves the IPv6 address of the SEH wired print server. This command is only supported on SEH print server models PS105-Z and PS102-Z with firmware version V60.16.5Z or V53.16.5Z and later.

Supported Devices

- SEH print server model PS105-Z with firmware version V60.16.5Z or V53.16.5Z and later.
- SEH print server model PS102-Z with firmware version V60.16.5Z or V53.16.5Z and later.

Type `getvar`

Commands	Details
<code>getvar</code>	This command retrieves the IPv6 address of the SEH wired print server. <i>Format:</i> <code>! U1 getvar "external_wired.ip.v6.addr"</code> <i>Values:</i> 8 group of four hexadecimal digits with a colon delimiter character set = A-F or 0-9 (39-character maximum)



Example • In this example, the `getvar` returns the IPv6 address of the wired print server.
`! U1 getvar "external_wired.ip.v6.addr"`



Note

- For printer support, see [SGD Command Support on page 1267](#).
- For details on SGD command structure, see [Command Structure on page 635](#).

external_wired.ip.v6.gateway

Description This command retrieves the IPv6 gateway of the SEH wired print server.

Supported Devices

- SEH print server model PS105-Z with firmware version V60.16.5Z or V53.16.5Z and later.
- SEH print server model PS102-Z with firmware version V60.16.5Z or V53.16.5Z and later.

Type `getvar`

Commands	Details
<code>getvar</code>	<p>This command retrieves the IPv6 gateway of the SEH wired print server.</p> <p><i>Format:</i> <code>! U1 getvar "external_wired.ip.v6.gateway"</code></p> <p><i>Values:</i></p> <p>8 group of four hexadecimal digits with a colon delimiter character set = A-F or 0-9 (39-character maximum)</p>



Example • In this example, the `getvar` returns the IPv6 gateway of the wired print server.

```
! U1 getvar "external_wired.ip.v6.gateway"
```



Note •

- For printer support, see [SGD Command Support on page 1267](#).
- For details on SGD command structure, see [Command Structure on page 635](#).

external_wired.ip.v6.prefix_length

Description This command retrieves the IPv6 address prefix length of the SEH wired print server.

Supported Devices

- SEH print server model PS105-Z with firmware version V60.16.5Z or V53.16.5Z and later.
- SEH print server model PS102-Z with firmware version V60.16.5Z or V53.16.5Z and later.

Type `getvar`

Commands	Details
<code>getvar</code>	This command retrieves the IPv6 address prefix length of the SEH wired print server. <i>Format:</i> <code>! U1 getvar "external_wired.ip.v6.prefix_length"</code> <i>Values:</i> character set = 0-9 (3-character maximum)



Example • In this example, the `getvar` returns the IPv6 address prefix length of the wired print server.

```
! U1 getvar "external_wired.ip.v6.prefix_length"
```



Note

- For printer support, see [SGD Command Support on page 1267](#).
- For details on SGD command structure, see [Command Structure on page 635](#).

external_wired.mac_addr

Description This command retrieves the MAC address of the external wired print server.

Type `getvar`

Commands	Details
<code>getvar</code>	This command instructs the printer to respond with the MAC address of the external wired print server. <i>Format:</i> <code>! U1 getvar "external_wired.mac_addr"</code>



Example • In this example, the `getvar` result is the MAC address of the external wired print server.

```
! U1 getvar "external_wired.mac_addr"
```



Note •

- For printer support, see [SGD Command Support on page 1267](#).
- For details on SGD command structure, see [Command Structure on page 635](#).

external_wired.mac_raw

Description This command specifies the RAW MAC address of the external print server. The raw mac address is the mac address without the colons (":").

Type `getvar`

Commands	Details
<code>getvar</code>	This command retrieves the RAW MAC address of the external print server. <i>Format:</i> <code>! U1 getvar "external_wired.mac_raw"</code>



Example • In this example, the `getvar` retrieves the RAW MAC address of the external print server.

```
! U1 getvar "external_wired.mac_raw"  
  
"00074d2408ff"
```



Note •

- For printer support, see [SGD Command Support on page 1267](#).
- For details on SGD command structure, see [Command Structure on page 635](#).

internal_wired.auto_switchover

Description This command instructs the printer to switch from wireless to the internal wired print server when an Ethernet cable is plugged into the printer and the printer detects an active data link.

Supported Devices

- ZM400/ZM600
- RZ400/RZ600



Important • For this command to work, be sure:

- you are using a ZM400/ZM600 or RZ400/RZ600 printer with both the internal 10/100 wired print server and wireless option board installed
- the value for this command is set to "on" (switchover enabled)
- the printer is currently communicating to the network through a wireless connection
- a Ethernet cable is plugged into the ZM400/ZM600 or RZ400/RZ600 printer and the printer recognizes a data link connection

When the above conditions exist and an active Ethernet cable is plugged into an internal wired print server, the printer will detect the wired data link and automatically switch to the wired interface. The printer will automatically switch back to the wireless interface when the Ethernet cable is disconnected.

Type setvar;getvar

Commands	Details
setvar	This command configures switches between the wireless and wired interfaces. <i>Format:</i> ! U1 setvar "internal_wired.auto_switchover" "value" <i>Values:</i> "on" = switchover enabled "off" = switchover disabled <i>Default:</i> "off"
getvar	This command retrieves the current automatic switchover value. <i>Format:</i> ! U1 getvar "internal_wired.auto_switchover"



Example • This setvar example shows the value set to "off".

```
! U1 setvar "internal_wired.auto_switchover" "off"
```

When the setvar value is set to "off", the getvar result is "off".



Note •

- For printer support, see [SGD Command Support on page 1267](#).
- For details on SGD command structure, see [Command Structure on page 635](#).

internal_wired.ip.addr

Description This command allows you to get or set the internal wired print servers's IP address.



Important • For a set IP address to take affect, the IP protocol must be set to permanent and the print server must be reset.

Type setvar;getvar

Commands	Details
setvar	This command instructs the printer to change its current internal wired print server IP address upon powering the printer on. <i>Format:</i> ! U1 setvar "internal_wired.ip.addr" "value" <i>Values:</i> any valid IP address <i>Default:</i> "0.0.0.0"
getvar	This command instructs the printer to respond with its current internal wired print server IP address. <i>Format:</i> ! U1 getvar "internal_wired.ip.addr"



Note • The setvar value of this command can be affected by the internal_wired.ip.dhcp.enable command.



Example • This setvar example shows the value set to "10.14.4.235".

```
! U1 setvar "internal_wired.ip.addr" "10.14.4.235"
```

What the setvar value is set to is the getvar result. In this example, the getvar result is "10.14.4.235".



Note •

- For printer support, see [SGD Command Support on page 1267](#).
- For details on SGD command structure, see [Command Structure on page 635](#).

internal_wired.ip.arp_interval

Description This print server setting allows you to specify the ARP (Address Resolution Protocol) interval or the ARP cache time out for the internal wired print server.

Type setvar;setvar

Commands	Details
setvar	This command instructs the printer to change the ARP interval or the ARP cache time out for the internal wired print server. <i>Format:</i> ! U1 setvar "internal_wired.ip.arp_interval" "value" <i>Values:</i> 0 - 30 <i>Default:</i> "0"
getvar	This command instructs the printer to respond with the ARP interval or the ARP cache time out value for the internal wired print server. <i>Format:</i> ! U1 getvar "internal_wired.ip.arp_interval"



Example • This `setvar` example shows the value set to "0".

```
! U1 setvar "internal_wired.ip.arp_interval" "0"
```

What the `setvar` value is set to is the `getvar` result. In this example, the `getvar` result is "0".



Note •

- For printer support, see [SGD Command Support on page 1267](#).
- For details on SGD command structure, see [Command Structure on page 635](#).

internal_wired.ip.default_addr_enable

Description This command allows you to default the internal wired print server's IP address.



Important • For a set IP address to take affect, the IP protocol must be set to permanent and the print server must be reset.

Type setvar;getvar

Commands	Details
setvar	<p>This command tells the printer to use it's default address, if no address is provided through DHCP or BOOTP. If you do not assign an IP address after 2 minutes, the 10/100 Internal PS defaults to IP address 192.168.254.254.</p> <p><i>Format:</i> ! U1 setvar "internal_wired.ip.default_addr_enable" "value"</p> <p><i>Values:</i> "on" = enabled "off" = disabled</p> <p><i>Default:</i> "on"</p>
getvar	<p>This command instructs the printer to show the status of the setting of internal wired print server's default IP address feature.</p> <p><i>Format:</i> ! U1 getvar "internal_wired.ip.default_addr_enable"</p>



Example • This `setvar` example shows the value set to "on".

```
! U1 setvar "internal_wired.ip.default_addr_enable" "on"
```

What the `setvar` value is set to is the `getvar` result. In this example, the `getvar` result is "on".



Note •

- For printer support, see [SGD Command Support on page 1267](#).
- For details on SGD command structure, see [Command Structure on page 635](#).

internal_wired.ip.dhcp.cache_ip

Description This command enables or disables the IP cache on the internal wired print server.

Supported Devices

- ZM400/ZM600
- RZ400/RZ600

Type setvar;setvar

Commands	Details
setvar	This command sets the status of the IP cache. <i>Format:</i> ! U1 setvar "internal_wired.ip.dhcp.cache_ip" "value" <i>Values:</i> "on" = enabled "off" = disabled <i>Default:</i> "off"
getvar	This command retrieves the status of the IP cache on the internal wired print server. <i>Format:</i> ! U1 getvar "internal_wired.ip.dhcp.cache_ip"



Example • This setvar example shows the value set to "off".

```
! U1 setvar "internal_wired.ip.dhcp.cache_ip" "off"
```

When the setvar value is set to "off", the getvar result is "off".



Note

- For printer support, see [SGD Command Support on page 1267](#).
- For details on SGD command structure, see [Command Structure on page 635](#).

internal_wired.ip.dhcp.cid_all

Description This printer setting defines the entire client identifier (DHCP option 61) if DHCP is enabled on the internal print server and "internal_wired.ip.dhcp.cid_type" is set to "0", or "2". The MAC address is used if the type is set to "1".

Type setvar;getvar

Commands	Details
setvar	<p>This command instructs the printer to change the client identifier prefix and suffix of the internal wired print server. The prefix gets cleared and the suffix contains the entire client identifier.</p> <p><i>Format:</i> ! U1 setvar "internal_wired.ip.dhcp.cid_all" "value"</p> <p><i>Values:</i> A maximum length of 60 characters if the CID type is ASCII, or 120 characters if the CID type is hexadecimal.</p> <p><i>Default Value:</i> ""</p>
getvar	<p>This command instructs the printer to respond with the client identifier prefix and suffix of the internal wired print server.</p> <p><i>Format:</i> ! U1 getvar "internal_wired.ip.dhcp.cid_all"</p>



Example • This setvar example shows the value set to "printer".

```
! U1 setvar "internal_wired.ip.dhcp.cid_all" "printer"
```

What the setvar value is set to is the getvar result. In this example, the getvar result is "printer".



Note •

- For printer support, see [SGD Command Support on page 1267](#).
- For details on SGD command structure, see [Command Structure on page 635](#).

internal_wired.ip.dhcp.cid_enable

Description This command determines if DHCP (option 61) is turned on or off of the internal wired print server.

Type setvar;getvar

Commands	Details
setvar	<p>This command instructs the printer to set the status of the client identifier of the internal wired print server.</p> <p><i>Format:</i> ! U1 setvar "internal_wired.ip.dhcp.cid_enable" "value"</p> <p><i>Values:</i></p> <ul style="list-style-type: none"> "off" = client identifier is turned off "on" = client identifier is turned on <p><i>Default:</i> "off"</p>
getvar	<p>This command instructs the printer to respond with the status of the client identifier of the internal wired print server.</p> <p><i>Format:</i> ! U1 getvar "internal_wired.ip.dhcp.cid_enable"</p>



Example • This `setvar` example shows the value set to "off".

```
! U1 setvar "internal_wired.ip.dhcp.cid_enable" "off"
```

What the `setvar` value is set to is the `getvar` result. In this example, the `getvar` result is "off".



Note •

- For printer support, see [SGD Command Support on page 1267](#).
- For details on SGD command structure, see [Command Structure on page 635](#).

internal_wired.ip.dhcp.cid_prefix

Description This printer setting defines the prefix to be prepended to the DHCP client identifier (option 61) when DHCP is enabled on the internal wired print server and "internal_wired.ip.dhcp.cid_type" is set to "0" or "2".

Type setvar;getvar

Commands	Details
setvar	This command instructs the printer to change the CID prefix of the internal wired print server. <i>Format:</i> ! U1 setvar "internal_wired.ip.dhcp.cid_prefix" "value" <i>Values:</i> Any text string up to 10 characters if the CID type is ASCII, or 20 characters if the CID type is hexadecimal. <i>Default Value:</i> ""
getvar	This command instructs the printer to respond with the client identifier prefix of the internal wired print server. <i>Format:</i> ! U1 getvar "internal_wired.ip.dhcp.cid_prefix"



Example • This setvar example shows the value set to "PRT001".

```
! U1 setvar "internal_wired.ip.dhcp.cid_prefix" "PRT001"
```

What the setvar value is set to is the getvar result. In this example, the getvar result is "PRT001".



Note •

- For printer support, see [SGD Command Support on page 1267](#).
- For details on SGD command structure, see [Command Structure on page 635](#).

internal_wired.ip.dhcp.cid_suffix

Description This printer setting defines the unique suffix to be used as the client identifier (DHCP option 61) if DHCP is enabled on the internal wired 10/100 print server and "internal_wired.ip.dhcp.cid_type" is set to "0" or "2".

Type setvar;getvar

Commands	Details
setvar	<p>This command instructs the printer to change the client identifier suffix value of the internal wired 10/100 print server.</p> <p><i>Format:</i> ! U1 setvar "internal_wired.ip.dhcp.cid_suffix" "value"</p> <p><i>Values:</i> The maximum length of a value allowed is 60 ASCII characters when the CID type is ASCII, or 120 hexadecimal values when the CID type is hexadecimal.</p> <p><i>Default:</i> ""</p>
getvar	<p>This command instructs the printer to respond with the client identifier suffix of the internal wired 10/100 print server.</p> <p><i>Format:</i> ! U1 getvar "internal_wired.ip.dhcp.cid_suffix"</p>



Example • This `setvar` example shows the value set to "printer".

```
! U1 setvar "internal_wired.ip.dhcp.cid_suffix" "printer"
```

What the `setvar` value is set to is the `getvar` result. In this example, the `getvar` result is "printer".



Note •

- For printer support, see [SGD Command Support on page 1267](#).
- For details on SGD command structure, see [Command Structure on page 635](#).

internal_wired.ip.dhcp.cid_type

Description This printer setting defines the type of client identifier (DHCP option 61) that will be sent if DHCP is enabled on the internal wired print server. A value of "1" means the type of "Ethernet" and the printer's MAC address will be used. A value of "0" or "2" means the client identifier sent will be "internal_wired.ip.dhcp.cid_prefix" concatenated with "internal_wired.ip.dhcp.cid_suffix".

Type setvar;getvar

Commands	Details
setvar	<p>This command instructs the printer to enable "synthetic" Client Identifier for the internal wired print server.</p> <p><i>Format:</i> ! U1 setvar "internal_wired.ip.dhcp.cid_type" "value"</p> <p><i>Values:</i></p> <ul style="list-style-type: none">"0" = ASCII string"1" = wired print server's MAC address"2" = HEX value <p><i>Default Value:</i> "1"</p>
getvar	<p>This command instructs the printer to respond with the client identifier type for the internal wired print server.</p> <p><i>Format:</i> ! U1 getvar "internal_wired.ip.dhcp.cid_type"</p>



Example • This `setvar` example shows the value set to "1".
! U1 setvar "internal_wired.ip.dhcp.cid_type" "1"

When the `setvar` value is set to "1", the `getvar` result is "1".



Note •

- For printer support, see [SGD Command Support on page 1267](#).
- For details on SGD command structure, see [Command Structure on page 635](#).

internal_wired.ip.dhcp.lease.last_attempt

Description This command retrieves the last time a DHCP request was sent from the internal wired print server.

Supported Devices

- ZM400/ZM600
- RZ400/RZ600

Type `getvar`

Commands	Details
<code>getvar</code>	This command retrieves the last time a DHCP request was sent from the internal wired print server. <i>Format:</i> <code>! U1 getvar "internal_wired.ip.dhcp.lease.last_attempt"</code>



Example • In this example, the `getvar` retrieves the last time a DHCP request was sent to the internal wired print server.

```
! U1 getvar "internal_wired.ip.dhcp.lease.last_attempt"
```



Note

- For printer support, see [SGD Command Support on page 1267](#).
- For details on SGD command structure, see [Command Structure on page 635](#).

internal_wired.ip.dhcp.lease.length

Description This command retrieves the original length (in seconds) of the DHCP lease on the internal wired print server.

Supported Devices

- ZM400/ZM600
- RZ400/RZ600

Type `getvar`

Commands	Details
<code>getvar</code>	This command retrieves the original length (in seconds) of the DHCP lease on the internal wired print server. <i>Format:</i> <code>! U1 getvar "internal_wired.ip.dhcp.lease.length"</code>



Example • In this example, the `getvar` returns the original length of the DHCP lease on the internal wired print server.

```
! U1 getvar "internal_wired.ip.dhcp.lease.length"

"691200"
```



Note

- For printer support, see [SGD Command Support on page 1267](#).
- For details on SGD command structure, see [Command Structure on page 635](#).

internal_wired.ip.dhcp.lease.server

Description This command retrieves the address of the server that provided the DHCP lease on the internal wired print server.

Supported Devices

- ZM400/ZM600
- RZ400/RZ600

Type `getvar`

Commands	Details
<code>getvar</code>	This command retrieves the address of the server that provided the DHCP lease on the internal wired print server. <i>Format:</i> <code>! U1 getvar "internal_wired.ip.dhcp.lease.server"</code>



Example • In this example, the `getvar` retrieves the address of the server that provided the DHCP lease on the internal wired print server.

```
! U1 getvar "internal_wired.ip.dhcp.lease.server"
```

```
"10.3.1.98"
```



Note

- For printer support, see [SGD Command Support on page 1267](#).
- For details on SGD command structure, see [Command Structure on page 635](#).

internal_wired.ip.dhcp.lease.time_left

Description This command retrieves the time (in seconds) left in the current DHCP lease on the internal wired print server.

Supported Devices

- ZM400/ZM600
- RZ400/RZ600

Type `getvar`

Commands	Details
<code>getvar</code>	This command retrieves the time (in seconds) left in the current DHCP lease on the internal wired print server. <i>Format:</i> <code>! U1 getvar "internal_wired.ip.dhcp.lease.time_left"</code>



Example • In this example, the `getvar` retrieves the time left in the current DHCP lease on the wired internal print server.

```
! U1 getvar "internal_wired.ip.dhcp.lease.time_left"
```

```
"10.3.1.98"
```



Note

- For printer support, see [SGD Command Support on page 1267](#).
- For details on SGD command structure, see [Command Structure on page 635](#).

internal_wired.ip.dhcp.option12

Description This command specifies if the DHCP option 12 (host name) is on or off in the discovery packet that is sent from the internal wired print server.

Supported Devices

- ZM400/ZM600
- RZ400/RZ600

Type setvar;getvar

Commands	Details
setvar	<p>This command instructs the printer to set the DHCP option 12 (host name) in the discovery packet of the internal wired print server.</p> <p><i>Format:</i></p> <pre>! U1 setvar "internal_wired.ip.dhcp.option12" "value"</pre> <p><i>Values:</i></p> <ul style="list-style-type: none"> "on" = turns on option 12 "off" = turns off option 12 <p><i>Default Value:</i> "on"</p>
getvar	<p>This command retrieves the status of the DHCP option 12 (host name) in the discovery packet of the internal wired print server.</p> <p><i>Format:</i></p> <pre>! U1 getvar "internal_wired.ip.dhcp.option12"</pre>



Example • This `setvar` example shows the value set to "on".

```
! U1 setvar "internal_wired.ip.dhcp.option12" "on"
```

When the `setvar` value is set to "on", the `getvar` result is "on".



Note

- For printer support, see [SGD Command Support on page 1267](#).
- For details on SGD command structure, see [Command Structure on page 635](#).

internal_wired.ip.dhcp.option12_format

Description This command specifies the value which will be used for option 12 (host name) to be used in the DHCP discovery packet of the internal wired print server.

Supported Devices

- ZM400/ZM600
- RZ400/RZ600

Type setvar;setvar

Commands	Details
setvar	<p>This command instructs the printer to set value which will be used for option 12 (host name) to be used in the DHCP discovery packet of the internal wired print server.</p> <p><i>Format:</i> ! U1 setvar "internal_wired.ip.dhcp.option12_format" "value"</p> <p><i>Values:</i> 0 to 109 alphanumeric characters <i>Default Value:</i> ""</p>
getvar	<p>This command retrieves the value which will be used for option 12 (host name) to be used in the DHCP discovery packet of the internal wired print server.</p> <p><i>Format:</i> ! U1 getvar "internal_wired.ip.dhcp.option12_format"</p>



Example • This `setvar` example shows configuring the `internal_wired.ip.dhcp.option12_format` to the value contained in the `device.friendly_name`.

It is necessary to surround the SGD entry to be used as source for the data with the `<` and `>` characters.

```
! U1 setvar "internal_wired.ip.dhcp.option12_format"
"<device.friendly_name>"
```

To further explain, if the above command was issued and the value currently stored in the `device.friendly_name` parameter was "ShipPrinter", then the response to following command would be "ShipPrinter":

```
! U1 getvar "internal_wired.ip.dhcp.option12_value"
```



Note

- For printer support, see [SGD Command Support on page 1267](#).
- For details on SGD command structure, see [Command Structure on page 635](#).

internal_wired.ip.dhcp.option12_value

Description This command retrieves the actual value which will be used in the discovery packet of the internal wired print server.

Supported Devices

- ZM400/ZM600
- RZ400/RZ600

Type `getvar`

Commands	Details
<code>getvar</code>	This command retrieves the actual value which will be used in the discovery packet of the internal wired print server. <i>Format:</i> <code>! U1 getvar "internal_wired.ip.dhcp.option12_value"</code>



Example • This `setvar` example shows configuring the `internal_wired.ip.dhcp.option12_format` to the value contained in the `device.friendly_name`.

It is necessary to surround the SGD entry to be used as source for the data with the `<` and `>` characters.

```
! U1 setvar "internal_wired.ip.dhcp.option12_format"
"<device.friendly_name>"
```

To further explain, if the above command was issued and the value currently stored in the `device.friendly_name` parameter was "ShipPrinter", then the response to following command would be "ShipPrinter":

```
! U1 getvar "internal_wired.ip.dhcp.option12_value"
```



Note

- For printer support, see [SGD Command Support on page 1267](#).
- For details on SGD command structure, see [Command Structure on page 635](#).

internal_wired.ip.dhcp.requests_per_session

Description This command retrieves the maximum amount of DHCP discover requests for a single DHCP session on the internal wired print server.

Supported Devices

- ZM400/ZM600
- RZ400/RZ600

Type setvar;setvar

Commands	Details
setvar	This command instructs the printer to set the maximum amount of DHCP discover requests for a single DHCP session on the internal wired print server. <i>Format:</i> ! U1 setvar "internal_wired.ip.dhcp.requests_per_session" "value" <i>Values:</i> 1-10 <i>Default:</i> "2"
getvar	This command retrieves the currently set maximum amount of DHCP discover requests for a single DHCP session on the internal wired print server. <i>Format:</i> ! U1 getvar "internal_wired.ip.dhcp.requests_per_session"



Example • This `setvar` example shows the value set to "2".

```
! U1 setvar "internal_wired.ip.dhcp.requests_per_session" "2"
```

When the `setvar` value is set to "2", the `getvar` result is "2".



Note

- For printer support, see [SGD Command Support on page 1267](#).
- For details on SGD command structure, see [Command Structure on page 635](#).

internal_wired.ip.dns.servers

Description This command retrieves a space delimited list of the domain name servers from an internal wired print server.

Type `getvar`

Commands	Details
<code>getvar</code>	This command retrieves a list of space delimited DNS internal wired print servers. <i>Format:</i> <code>! U1 getvar "internal_wired.ip.dns.servers"</code>



Example • In this example, the `getvar` retrieves a list of space delimited DNS wireless print servers.

```
! U1 getvar "internal_wired.ip.dns.servers"
```



Note •

- For printer support, see [SGD Command Support on page 1267](#).
- For details on SGD command structure, see [Command Structure on page 635](#).

internal_wired.ip.gateway

Description This command instructs the printer to change the internal wired print servers gateway address.



Important • This setting refers to the gateway address. A set value is ignored if the IP protocol is not set to permanent.

Type setvar;getvar

Commands	Details
setvar	This command instructs the printer to change the internal wired printer servers gateway address. <i>Format:</i> ! U1 setvar "internal_wired.ip.gateway" "value" <i>Values:</i> Any valid gateway address <i>Default:</i> "0.0.0.0"
getvar	This command instructs the printer to respond with the internal wired printer servers gateway address. <i>Format:</i> ! U1 getvar "internal_wired.ip.gateway"



Example • This setvar example shows the value set to "10.3.5.1".

```
! U1 setvar "internal_wired.ip.gateway" "10.3.5.1"
```

When the setvar value is set to "10.3.5.1", the getvar result is "10.3.5.1".



Note •

- For printer support, see [SGD Command Support on page 1267](#).
- For details on SGD command structure, see [Command Structure on page 635](#).

internal_wired.ip.netmask

Description This setting refers to the internal wired print server’s subnet mask address. This value is ignored if the IP protocol is not set to permanent.

Type setvar;setvar

Commands	Details
setvar	This command instructs the printer to change the internal wired print servers subnet mask. <i>Format:</i> ! U1 setvar "internal_wired.ip.netmask" "value" <i>Values:</i> Any valid subnet mask. <i>Default:</i> "255.255.255.0"
getvar	This command instructs the printer to respond with internal wired print servers subnet mask. <i>Format:</i> ! U1 getvar "internal_wired.ip.netmask"



Example • This `setvar` example shows the value set to "255.255.255.0".

```
! U1 setvar "internal_wired.ip.netmask" "255.255.255.0"
```

When the `setvar` value is set to "255.255.255.0", the `getvar` result is "255.255.255.0".



Note •

- For printer support, see [SGD Command Support on page 1267](#).
- For details on SGD command structure, see [Command Structure on page 635](#).

internal_wired.ip.port

Description This printer setting refers to the internal wired print servers port number that the TCP print service is listening on. Normal TCP communications from the host should be directed to this port.

Type setvar;getvar

Commands	Details
setvar	This command instructs the printer to set the internal wired print servers TCP/UDP port number. <i>Format:</i> ! U1 setvar "internal_wired.ip.port" "value" <i>Values:</i> 1 - 65535 (excluding any ports currently used by other services, such as 21, 23, 80, and 515). <i>Default:</i> "9100"
getvar	This command instructs the printer to respond with the internal wired printer servers TCP/UDP port number. <i>Format:</i> ! U1 getvar "internal_wired.ip.port"



Example • This `setvar` example shows the value set to "9100".

```
! U1 setvar "internal_wired.ip.port" "9100"
```

When the `setvar` value is set to "9100", the `getvar` result is "9100".



Note •

- For printer support, see [SGD Command Support on page 1267](#).
- For details on SGD command structure, see [Command Structure on page 635](#).

internal_wired.ip.port_alternate

Description This command sets the port number of the alternate port.



Note • Print servers supporting this command will monitor both the primary port and the alternate port for connections at the same time.

Supported Devices ZT200 Series

Type setvar;setvar

Commands	Details
setvar	This command sets the alternate port for the print server. <i>Format:</i> ! U1 setvar "internal_wired.ip.port_alternate" "value" <i>Values:</i> Any valid TCP port address. <i>Default:</i> "9100"
getvar	This command returns the current alternate port setting. <i>Format:</i> ! U1 setvar "internal_wired.ip.port_alternate" <i>Values:</i> The current port setting.



Note •

- For printer support, see [SGD Command Support on page 1267](#).
- For details on SGD command structure, see [Command Structure on page 635](#).

internal_wired.ip.port_json_config

Description This command determines the TCP port number to listen on for JSON configuration packets.

Supported Devices

- iMZ 220™, iMZ 320™
- QLn220™, QLn320™, QLn420™
- ZT210™, ZT220™, ZT230™

Type setvar, getvar

Commands	Details
setvar	This command sets the TCP port number to listen on for JSON configuration packets. <i>Format:</i> ! U1 setvar "internal_wired.ip.port_json_config" "value" <i>Values:</i> <ul style="list-style-type: none">• 0 = disable the port• 1-65535 = Port number to listen on. Note • Ports that are already in use or the standard network ports are invalid values. <i>Default:</i> "9200"
getvar	This command retrieves the port number. <i>Format:</i> ! U1 getvar "internal_wired.ip.port_json_config"



Example • This example sets the port value to listen on as 1234.

```
! U1 setvar "internal_wired.ip.port_json_config" "1234"
```



Note •

- For printer support, see [SGD Command Support on page 1267](#).
- For details on SGD command structure, see [Command Structure on page 635](#).

internal_wired.ip.protocol

Description This command configures the IP addressing method used by the internal wired print server.

Type setvar;getvar

Commands	Details
setvar	<p>This command instructs the printer to configure the IP addressing method used by the internal wired print server.</p> <p><i>Format:</i> ! U1 setvar "internal_wired.ip.protocol" "value"</p> <p><i>Values:</i></p> <ul style="list-style-type: none"> "bootp" = uses the standard bootp addressing method to obtain an IP address and configuration "dhcp" = uses the standard dhcp addressing method to obtain an IP address and configuration for a server specified period of time "rarp" = uses the standard rarp addressing method to obtain an IP address "glean" = uses the IP address from a PING packet that is sent to its hardware address (unicast address) "permanent" = uses static values assigned through other commands "all" = tries all of the dynamic addressing methods, not permanent, to obtain an IP address <p><i>Default:</i> "all"</p>
getvar	<p>This command returns the IP addressing method used by the internal wired print server.</p> <p><i>Format:</i> ! U1 getvar "internal_wired.ip.protocol"</p>



Example • In this example, the `setvar` result is the current programming language that the printer is using.

```
! U1 setvar "internal_wired.ip.protocol" "bootp"
```

What the `setvar` value is set to is the `getvar` result. In this example, the `getvar` result is "bootp".



Note •

- For printer support, see [SGD Command Support on page 1267](#).
- For details on SGD command structure, see [Command Structure on page 635](#).

internal_wired.ip.timeout.enable

Description This network setting refers to enabling the connection timeout on the internal wired print server. For this to take effect, the print server must be reset.

Type setvar;setvar

Commands	Details
setvar	<p>This command instructs the printer to enable or disable the timeout checking on the internal wired print server.</p> <p><i>Format:</i> ! U1 setvar "internal_wired.ip.timeout.enable" "value"</p> <p><i>Values:</i></p> <ul style="list-style-type: none">"off" = turns off the connection checking"on" = turns on the connection checking <p><i>Default:</i> "on"</p>
getvar	<p>This command instructs the printer to return whether the timeout checking is enabled on the internal wired print server.</p> <p><i>Format:</i> ! U1 getvar "internal_wired.ip.timeout.enable"</p>



Example • This setvar example shows the value set to "on".
! U1 setvar "internal_wired.ip.timeout.enable" "on"
When the setvar value is set to "on", the getvar result is "on".



Note •

- For printer support, see [SGD Command Support on page 1267](#).
- For details on SGD command structure, see [Command Structure on page 635](#).

internal_wired.ip.timeout.value

Description This network setting refers to the number of seconds before the connection times out for the internal wired print server. For this to take effect, the print server must be reset.

Type setvar;getvar

Commands	Details
setvar	<p>This command instructs the printer to set the time of the internal wired print server, in seconds, before the connection times out.</p> <p><i>Format:</i> ! U1 setvar "internal_wired.ip.timeout.value" "value"</p> <p><i>Values:</i> "1" through "3600"</p> <p><i>Default:</i> "300"</p>
getvar	<p>This command instructs the printer to respond with the time of the internal wired print server, in seconds, before the connection times out.</p> <p><i>Format:</i> ! U1 getvar "internal_wired.ip.timeout.value"</p>



Example • This `setvar` example shows the value set to "300".

```
! U1 setvar "internal_wired.ip.timeout.value" "300"
```

When the `setvar` value is set to "300", the `getvar` result is "300".



Note •

- For printer support, see [SGD Command Support on page 1267](#).
- For details on SGD command structure, see [Command Structure on page 635](#).

internal_wired.mac_addr

Description This command retrieves the MAC address of the internal wired print server.

Type `getvar`

Commands	Details
<code>getvar</code>	This command instructs the printer to respond with the MAC address of the internal wired print server. <i>Format:</i> <code>! U1 getvar "internal_wired.mac_addr"</code>



Example • In this example, the `getvar` result is the MAC address of the internal wired print server.

```
! U1 getvar "internal_wired.mac_addr"
```



Note •

- For printer support, see [SGD Command Support on page 1267](#).
- For details on SGD command structure, see [Command Structure on page 635](#).

internal_wired.mac_raw

Description This command identifies the RAW MAC address of the internal wired print server. The raw mac address is the mac address without the colons (":").

Supported Devices

- ZM400/ZM600
- RZ400/RZ600

Type `getvar`

Commands	Details
<code>getvar</code>	This command retrieves the RAW MAC address of the internal wired print server. <i>Format: ! U1 getvar "internal_wired.mac_raw"</i>



Example • In this example, the `getvar` retrieves the RAW MAC address of the internal wired print server.

```
! U1 getvar "internal_wired.mac_raw"
```



Note •

- For printer support, see [SGD Command Support on page 1267](#).
- For details on SGD command structure, see [Command Structure on page 635](#).



Notes • _____

SGD Wireless Commands

This chapter provides a high-level overview of the wireless Set / Get / Do (SGD) commands and details on each SGD command. For printer support of these SGD commands, see [SGD Command Support](#) on page 1267.



SGD commands are available in printers with the following firmware versions or later:

- V60.16.2Z or later
- V60.15.xZ or later
- V50.15.xZ or later
- V61.15.xZ or later
- V56.15.xZ or later
- V53.16.x or later
- V53.15.2Z or later
- R53.16.3Z or later
- R60.15.8Z or later
- R62.15.8Z or later
- R63.15.8Z or later
- R65.15.8Z or later



Note • The commands listed in this chapter are for use with the Wireless Print Server and Wireless Plus Print Server, when used with firmware version V60.15.x, V50.15.x, or later.



Important • These are important points to note when using ZPL and SGD commands:

- SGD commands are case-sensitive.
- ZPL and SGD commands should be sent to the printer as separate files.
- Certain settings can be controlled by both ZPL and SGD. Configuration changes made in ZPL can affect configuration changes made in SGD.
- Changes made with one command type (ZPL or SGD) will affect the data returned to the host in response to both ZPL and getvar commands. The command type (ZPL or SGD) that was sent last determines the current setting.
- Some RF cards do not support all of the SGD commands.



Important • These are important points to note when using a Zebra G-Series printer:

- You can send instructions to the printer using multiple programming languages: EPL, ZPL, or SGD. EPL and ZPL commands configure the printer, print labels, and get device status information. SGD commands set and get configuration details. These three languages can be used without the need to send the printer instructions to switch from one language to another.
- EPL, ZPL, and SGD commands must be sent to the printer as separate files. They cannot be used together in one format, or set of commands. For example, if you send a series of SGD commands to the printer and they are followed by a printable format, this needs to be done using separate files.

Overview

This section describes how and why to use the Set / Get / Do (SGD) commands. It also provides an example of a typical command structure.



Note • SGD commands must be terminated by a carriage return or a space and line feed.

SGD commands are commands that allow you to configure all printers with firmware version V60.15.x, V50.15.x, V61.15.x, V56.15.x, V53.15.xZ, or later. The printer performs the specified function immediately after receiving the command. The commands are:

- **setvar**
- **getvar**
- **do**

setvar Command

Setvar commands:

- are used to configure printer settings to specific values by setting them in the printer
- must be terminated by a space character or a CR/ LF (0x0D, 0x0A)



Important • The setvar command and attributes must be specified in lower case.

getvar Command

Getvar commands:

- are used to get the current value of the printer settings
- must be terminated by a space character or CR/LF (0x0D, 0x0A)

The printer responds with the printer setting of “?” if:

- the printer setting does not exist (usually due to incorrect spelling of the printer setting)
- it has not been configured yet



Important • The printer settings and attributes must be specified in lower case.

do Command

Do commands:

- are used to instruct the printer to perform predefined actions
- must be terminated by a space character or a CR/LF (0x0D, 0x0A)

Some **Do** commands require additional settings which must be enclosed in double quotes.



Important • The values must be specified in lower case.

Command Structure

It is important to understand the structure of the command and its components. A command structure illustration is provided for each command in this guide.

→ **Example** • This is an example of a command structure illustration:

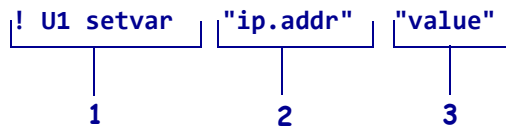

1	Command—always preceded with an exclamation point (!) and must be specified in lower case. A space resides between the ! and U1 and between U1 and the command (setvar or getvar).
2	Attribute—always in double quotes and must be specified in lower case.
3	Chosen value—always in double quotes. Only applicable for setvar and do .

This command must be terminated by a space character or a CR/ LF (0x0D, 0x0A).

How to Send Multiple SGD Commands

For any **getvar**, **setvar**, or **do** command, if you issue the syntax without the "1" and use the END command followed by a space, multiple SGD commands are sent simultaneously.

→ **Example** • This syntax shows how you can send multiple **getvar** commands:

```

1 → ! U getvar "ip.telnet.enable"
2 → | getvar "ip.dhcp.enable"
   | getvar "ip.dhcp.cid_prefix"
3 → | END
  
```

1	The command portion of the string does not use the "1" after the "! U".
2	Commands issued after the first command do not require the "! U".
3	The string of commands is terminated by the word "END" with a space after the word, and by a carriage return/ line feed.

bluetooth.address

Description This command returns the printer's Bluetooth device address.

Type `getvar`

Commands	Details
<code>getvar</code>	This command retrieves the printer's Bluetooth address. <i>Format:</i> <code>! U1 getvar "bluetooth.address"</code>



Example • In this example, the `getvar` command causes the printer to return the printer's Bluetooth address.

```
! U1 getvar "bluetooth.address"
```



Note •

- For printer support, see [SGD Command Support on page 1267](#).
- For details on SGD command structure, see [Command Structure on page 635](#).

bluetooth.afh_map

Description This command sets or retrieves the default AFH (adaptive frequency hopping) channel map (Bluetooth radios 1.2 and later); 20 bytes.

Type setvar;getvar

Commands	Details
setvar	This command selectively enables or disables individual Bluetooth channels for use when AFH mode is set to "on". <i>Format:</i> ! U1 setvar "bluetooth.afh_map" "value" <i>Values:</i> 20-byte string of hexadecimal characters <i>Default:</i> "7FFFFFFFFFFFFFFFFFFFFF"
getvar	This command retrieves default AFH channel map. <i>Format:</i> ! U1 getvar "bluetooth.afh_map"



Example • This `setvar` example shows the value set to "7FFFFFFFFFFFFFFFFFFFFF".

```
! U1 setvar "bluetooth.afh_map" "7FFFFFFFFFFFFFFFFFFFFF"
```

What the `setvar` value is set to is the `getvar` result. In this example, the `getvar` result is "7FFFFFFFFFFFFFFFFFFFFF".



Note •

- For printer support, see [SGD Command Support on page 1267](#).
- For details on SGD command structure, see [Command Structure on page 635](#).

bluetooth.afh_map_curr

Description This command retrieves the current AFH (adaptive frequency hopping) channel map (Bluetooth radios 1.2 and later).

Type `getvar`

Commands	Details
<code>getvar</code>	This command retrieves the current AFH channel map. <i>Format:</i> <code>! U1 getvar "bluetooth.afh_map_curr"</code>



Example • In this example, the `getvar` command causes the printer to retrieve the current AFH channel map.

```
! U1 getvar "bluetooth.afh_map_curr"
```



Note •

- For printer support, see [SGD Command Support on page 1267](#).
- For details on SGD command structure, see [Command Structure on page 635](#).

bluetooth.afh_mode

Description This command sets or retrieves AFH (adaptive frequency hopping) mode setting (Bluetooth radios 1.2 and later).

Type setvar;getvar

Commands	Details
setvar	This command enables and disables AFH mode. <i>Format:</i> ! U1 setvar "bluetooth.afh_mode" "value" <i>Values:</i> "on" = enables AFH mode "off" = disables AFH mode <i>Default:</i> "off"
getvar	This command retrieves the current setting of the AFH mode. <i>Format:</i> ! U1 getvar "bluetooth.afh_mode"



Example • This `setvar` example shows the value set to "on".

```
! U1 setvar "bluetooth.afh_mode" "on"
```

What the `setvar` value is set to is the `getvar` result. In this example, the `getvar` result is "on".



Note •

- For printer support, see [SGD Command Support on page 1267](#).
- For details on SGD command structure, see [Command Structure on page 635](#).

bluetooth.authentication

Description This command sets or retrieves Bluetooth authentication mode and works in combination with the `bluetooth.bluetooth_pin`.

Type `setvar;getvar`

Commands	Details
<code>setvar</code>	<p>This command enables and disables Bluetooth authentication.</p> <p><i>Format:</i> <code>! U1 setvar "bluetooth.authentication" "value"</code></p> <p><i>Values:</i></p> <ul style="list-style-type: none"> <code>"off"</code> = disables authentication (can connect to master device without PIN) <code>"setpin"</code> = enables authentication (requires PIN or passkey to connect to a master device) <p><i>Default:</i> <code>"off"</code></p>
<code>getvar</code>	<p>This command retrieves the current Bluetooth authentication mode.</p> <p><i>Format:</i> <code>! U1 getvar "bluetooth.authentication"</code></p>



Example • This `setvar` example shows the value set to `"setpin"`.

```
! U1 setvar "bluetooth.authentication" "setpin"
```

What the `setvar` value is set to is the `getvar` result. In this example, the `getvar` result is `"setpin"`.



Note •

- For printer support, see [SGD Command Support on page 1267](#).
- For details on SGD command structure, see [Command Structure on page 635](#).

bluetooth.bluetooth_pin

Description This command is used to connect to the printer only when the command `bluetooth.authentication` is set to "setpin".

Type setvar;getvar

Commands	Details
setvar	This command sets the Bluetooth pin value. <i>Format:</i> ! U1 setvar "bluetooth.bluetooth_pin" "value" <i>Values:</i> Any text string up to 10 characters <i>Default:</i> ""
getvar	This command retrieves the current Bluetooth pin. <i>Format:</i> ! U1 getvar "bluetooth.bluetooth_pin"



Example • This `setvar` example shows the value set to "1234567890".

```
! U1 setvar "bluetooth.bluetooth_pin" "1234567890"
```

What the `setvar` value is set to is the `getvar` result. In this example, the `getvar` result is "1234567890".



Note •

- For printer support, see [SGD Command Support on page 1267](#).
- For details on SGD command structure, see [Command Structure on page 635](#).

bluetooth.date

Description This command shows the release date of the Bluetooth module.

Type `getvar`

Commands	Details
<code>getvar</code>	This command shows the release date of the Bluetooth module. <i>Format:</i> <code>! U1 getvar "bluetooth.date"</code>



Example • In this example, the `getvar` command returns the release date of the Bluetooth module.

```
! U1 getvar "bluetooth.date"
```



Note •

- For printer support, see [SGD Command Support on page 1267](#).
- For details on SGD command structure, see [Command Structure on page 635](#).

bluetooth.discoverable

Description This command enables or disables the Bluetooth discoverable mode.

Type setvar;getvar

Commands	Details
setvar	This command enables or disables the Bluetooth discoverable mode. <i>Format:</i> ! U1 setvar "bluetooth.discoverable" "value" <i>Values:</i> "on" = enables Bluetooth discoverable mode "off" = disables Bluetooth discoverable mode <i>Default:</i> "on"
getvar	This command retrieves the current Bluetooth discoverable mode. <i>Format:</i> ! U1 getvar "bluetooth.discoverable"



Example • This `setvar` example shows the value set to "on".

```
! U1 setvar "bluetooth.discoverable" "on"
```

What the `setvar` value is set to is the `getvar` result. In this example, the `getvar` result is "on".



Note •

- For printer support, see [SGD Command Support on page 1267](#).
- For details on SGD command structure, see [Command Structure on page 635](#).

bluetooth.enable

Description This command enables or disables the Bluetooth radio.

Type setvar;getvar

Commands	Details
setvar	This command enables or disables the Bluetooth radio. <i>Format:</i> ! U1 setvar "bluetooth.enable" <i>Values:</i> "on" = enables the Bluetooth radio "off" = disables the Bluetooth radio <i>Default:</i> "on"
getvar	This command retrieves the current status of the Bluetooth radio. <i>Format:</i> ! U1 getvar "bluetooth.enable"



Example • This `setvar` example shows the value set to "on".

```
! U1 setvar "bluetooth.enable" "on"
```

What the `setvar` value is set to is the `getvar` result. In this example, the `getvar` result is "on".



Note •

- For printer support, see [SGD Command Support on page 1267](#).
- For details on SGD command structure, see [Command Structure on page 635](#).

bluetooth.friendly_name

Description This command sets the friendly name, which is used during service discovery. For changes to take effect, you must power cycle the printer or issue the `device.reset` command. If `bluetooth.friendly_name` is not set by you, it will default to the printer serial number.

Type `setvar;getvar`

Commands	Details
<code>setvar</code>	This command sets the Bluetooth discoverable mode. <i>Format:</i> <code>! U1 setvar "bluetooth.friendly_name" "value"</code> <i>Values:</i> Any text string up to 17 characters
<code>getvar</code>	This command retrieves the current Bluetooth discoverable mode. <i>Format:</i> <code>! U1 getvar "bluetooth.friendly_name"</code>



Example • This `setvar` example shows the value set to "1234567".

```
! U1 setvar "bluetooth.friendly_name" "1234567"
```

What the `setvar` value is set to is the `getvar` result. In this example, the `getvar` result is "1234567".



Note •

- For printer support, see [SGD Command Support on page 1267](#).
- For details on SGD command structure, see [Command Structure on page 635](#).

bluetooth.local_name

Description This command retrieves the local name that is provided during service discovery.

Type `getvar`

Commands	Details
<code>getvar</code>	This command retrieves the local name that is provided during service discovery. <i>Format:</i> <code>! U1 getvar "bluetooth.local_name"</code>



Example • In this example, the `getvar` command returns the local name that is provided during service discovery.

```
! U1 getvar "bluetooth.local_name"
```



Note •

- For printer support, see [SGD Command Support on page 1267](#).
- For details on SGD command structure, see [Command Structure on page 635](#).

bluetooth.minimum_security_mode

Description This printer setting parameter sets the Bluetooth Minimum Security mode. Minimum Security Mode provides for three levels of security, depending on the printer radio version and printer firmware: “1”, “2”, and “3”.



Important • This feature is available in printers with Bluetooth® radio version 2.0 or higher.

Type `setvar;getvar`

Supported Devices

- EZ320™
- Link-OS printers with firmware Vxx.19.7Z and later.

Commands	Details
<code>setvar</code>	<p>Sets the Bluetooth Minimum Security mode</p> <p><i>Format:</i> <code>! U1 setvar "bluetooth.minimum_security_mode" "value"</code></p> <p><i>Values:</i></p> <ul style="list-style-type: none"> "1" = Security mode 1 - the printer will: <ul style="list-style-type: none"> • be discoverable • not require a PIN to connect to "2" = the printer will: <ul style="list-style-type: none"> • switch to bluetooth.authentication = "setpin" (Connecting device must provide the printer's bluetooth.bluetooth_pin), • switch to Bluetooth.encryption = "on", and • use existing Bluetooth.discoverable setting "3" = Link Level Enforced Security - the printer will: <ul style="list-style-type: none"> • switch to bluetooth.authentication = "setpin" (Connecting device must provide the printer's bluetooth.bluetooth_pin) • switch to bluetooth.encryption = "on" • switch to bluetooth.discoverable = "off" • only connect to devices which use Link Level Enforced Security <p><i>Default:</i> "1"</p>
<code>getvar</code>	<p>Retrieves the current Bluetooth Minimum Security Mode.</p> <p><i>Format:</i> <code>! U1 getvar "bluetooth.minimum_security_mode"</code></p>



Example • This `setvar` example shows the value set to "2".

```
! U1 setvar "bluetooth.minimum_security_mode" "2"
```



Note •

- For printer support, see [SGD Command Support on page 1267](#).
- For details on SGD command structure, see [Command Structure on page 635](#).

bluetooth.radio_auto_baud

Description This command retrieves the Bluetooth radio data rate.

Type `getvar`

Commands	Details
<code>getvar</code>	This command retrieves Bluetooth radio data rate. <i>Format:</i> <code>! U1 getvar "bluetooth.radio_auto_baud"</code>



Example • In this example, the `getvar` retrieves the short Bluetooth address.
`! U1 getvar "bluetooth.radio_auto_baud"`



Note •

- For printer support, see [SGD Command Support on page 1267](#).
- For details on SGD command structure, see [Command Structure on page 635](#).

bluetooth.radio_version

Description This command returns the version of the currently installed Bluetooth radio.

Type `getvar`

Commands	Details
<code>getvar</code>	This command returns the version of the currently installed Bluetooth radio. <i>Format:</i> ! U1 <code>getvar "bluetooth.radio_version"</code>



Example • In this example, the `getvar` command returns the currently installed Bluetooth radio.

```
! U1 getvar "bluetooth.radio_version"
```



Note •

- For printer support, see [SGD Command Support on page 1267](#).
- For details on SGD command structure, see [Command Structure on page 635](#).

bluetooth.short_address

Description This command shortens the Bluetooth address by removing the colons (":").

Type `getvar`

Commands	Details
<code>getvar</code>	This command retrieves the shortened Bluetooth address. <i>Format:</i> <code>! U1 getvar "bluetooth.short_address"</code>



Example • In this example, the `getvar` retrieves the short Bluetooth address.

```
! U1 getvar "bluetooth.short_address"
```



Note •

- For printer support, see [SGD Command Support on page 1267](#).
- For details on SGD command structure, see [Command Structure on page 635](#).

bluetooth.version

Description This command returns the Bluetooth library version number.

Type `getvar`

Commands	Details
<code>getvar</code>	This command returns the Bluetooth library version number. <i>Format:</i> <code>! U1 getvar "bluetooth.version"</code>



Example • In this example, the `getvar` command returns the Bluetooth library version number.

`! U1 getvar "bluetooth.version"`



Note •

- For printer support, see [SGD Command Support on page 1267](#).
- For details on SGD command structure, see [Command Structure on page 635](#).

card.mac_addr

Description This command retrieves the MAC address of the wireless radio card.

Type `getvar`

Commands	Details
<code>getvar</code>	This command instructs the printer to respond with the MAC address. <i>Format:</i> <code>! U1 getvar "card.mac_addr"</code>



Example • In this example, the `getvar` result is the MAC address for the wireless radio card.

```
! U1 getvar "card.mac_addr"
```



Note •

- For printer support, see [SGD Command Support on page 1267](#).
- For details on SGD command structure, see [Command Structure on page 635](#).

card.inserted

Description This command indicates whether the wireless radio card is or is not inserted.

Type `getvar`

Commands	Details
<code>getvar</code>	This command instructs the printer to respond with the wireless radio card status. It's inserted or it's not inserted. <i>Format:</i> <code>! U1 getvar "card.inserted"</code>



Example • In this example, the `getvar` result is "Inserted".

```
! U1 getvar "card.inserted"
```



Note •

- For printer support, see [SGD Command Support on page 1267](#).
- For details on SGD command structure, see [Command Structure on page 635](#).

ip.active_network

Description This command displays if the printer is actively connected to wireless, external wired, or internal wired.

Type `getvar`

Commands	Details
<code>getvar</code>	This command instructs the printer to respond with what the printer is currently connected to internal wired, wireless, external wired, or unknown. Table 30 provides details on the potential return values. <i>Format:</i> <code>! U1 getvar "ip.active_network"</code>



Example • In this example, the `getvar` will return the current active network the printer is connected to.

```
! U1 getvar "ip.active_network"
```

Table 30 • Printer Responses

Return Values	Details
"internal wired"	This is the return value when an internal wired device is detected.
"wireless"	This is the return value when a wireless device is detected.
"external wired"	This is the return value when an external wired device is detected.
"unknown"	This is the return value: <ul style="list-style-type: none"> • if the printer has not established a network connection on any of the devices • if you don't have any of the network devices plugged in • if the printer is still trying to establish a connection (i.e. on wireless it is going through the association process).



Note •

- For printer support, see [SGD Command Support on page 1267](#).
- For details on SGD command structure, see [Command Structure on page 635](#).

ip.addr

Description This command allows you to get or set the printer's IP address.



Important • For a set IP address to take affect, the IP protocol must be set to permanent and the print server must be reset.

Type `setvar;getvar`

Commands	Details
<code>setvar</code>	<p>This command instructs the printer to change its current IP address upon powering the printer on.</p> <p><i>Format:</i> <code>! U1 setvar "ip.addr" "value"</code></p> <p><i>Values:</i> any valid IP address</p> <p><i>Default:</i> <code>"0.0.0.0"</code></p>
<code>getvar</code>	<p>This command instructs the printer to respond with its current IP address.</p> <p><i>Format:</i> <code>! U1 getvar "ip.addr"</code></p>



Note • The `setvar` value of this command can be affected by the `ip.dhcp.enable` command.



Example • This `setvar` example shows the value set to `"10.14.4.235"`.

```
! U1 setvar "ip.addr" "10.14.4.235"
```

What the `setvar` value is set to is the `getvar` result. In this example, the `getvar` result is `"10.14.4.235"`.



Note •

- For printer support, see [SGD Command Support on page 1267](#).
- For details on SGD command structure, see [Command Structure on page 635](#).

ip.arp_interval

Description This printer setting allows you to specify the ARP (Address Resolution Protocol) interval or the ARP cache time out.

Type setvar;setvar

Commands	Details
setvar	This command instructs the printer to change the ARP interval or the ARP cache time out. <i>Format:</i> ! U1 setvar "ip.arp_interval" "value" <i>Values:</i> 0 - 30 <i>Default:</i> "0"
getvar	This command instructs the printer to respond with the ARP interval or the ARP cache time out value in seconds. <i>Format:</i> ! U1 getvar "ip.arp_interval"



Example • This `setvar` example shows the value set to "0".

```
! U1 setvar "ip.arp_interval" "0"
```

What the `setvar` value is set to is the `getvar` result. In this example, the `getvar` result is "0".



Note •

- For printer support, see [SGD Command Support on page 1267](#).
- For details on SGD command structure, see [Command Structure on page 635](#).

ip.bootp.enable

Description This printer setting turns BOOTP on or off. BOOTP is a method for acquiring an IP address, netmask, and gateway automatically on printer power-up. It requires a BOOTP server on the local network.



Note • If you are using static IP addressing, the IP protocol must be set to permanent.

Type setvar;getvar

Commands	Details
setvar	<p>This command instructs the printer to turn BOOTP on or off.</p> <p><i>Format:</i> ! U1 setvar "ip.bootp.enable" "value"</p> <p><i>Values:</i></p> <ul style="list-style-type: none"> "off" = printer does not use BOOTP to get the IP address "on" = printer uses BOOTP to get the IP address <p><i>Default:</i> "on"</p>
getvar	<p>This command instructs the printer to respond with the current BOOTP setting.</p> <p><i>Format:</i> ! U1 getvar "ip.bootp.enable"</p>



Example • This setvar example shows the value set to "on".

```
! U1 setvar "ip.bootp.enable" "on"
```

When the setvar value is set to "on", the getvar result is "on".



Note •

- For printer support, see [SGD Command Support on page 1267](#).
- For details on SGD command structure, see [Command Structure on page 635](#).

ip.dhcp.arp_verify

Description This command configures the print server to send out an ARP request during the DHCP address negotiation. This is used to verify if the IP address received from the DHCP server is in use.

- If an ARP reply is received, a DHCP DECLINE message is sent to the DHCP server telling it that the received address cannot be used and then the normal DHCP procedure is restarted.
- If no ARP reply is received the DHCP address is used.

Supported Devices ZT200 Series

Type setvar;getvar;do

Commands	Details
setvar	This command instructs the printer to turn on ARP verify. <i>Format:</i> ! U1 setvar "ip.dhcp.arp_verify" "value" <i>Values:</i> "on" "off" <i>Default:</i> "off"
getvar	This command returns whether the printer will send the ARP request during the DHCP negotiation. <i>Format:</i> ! U1 getvar "ip.dhcp.arp_verify"



Example • This setvar example shows the value set to "on".

```
! U1 setvar "ip.dhcp.arp_verify" "on"
```



Note •

- For printer support, see [SGD Command Support on page 1267](#).
- For details on SGD command structure, see [Command Structure on page 635](#).

ip.dhcp.auto_provision_enable

Description This command prepares the printer to receive Weblink settings from the DHCP server. These settings are used to allow the printer to connect to on-premise or web-based servers.

If DHCP receives option 43 in the format of "10642 <auto provision code> < auto provision settings>" and the Client is not already configured, the client will use the configuration to connect to the server.

Using this feature requires configuring your DHCP server to send option 43 information during address assignment. The feature allows the printer to obtain the settings used to control Cloud Connect weblink connections or Mirror events as part of receiving a DHCP assigned IP address. This requires that DHCP option 60 is not empty and that `ip.dhcp.auto_provision_enable` is set to "on".

The package of Cloud Connect/weblink information sent from the DHCP server in the Option 43 response can include the:

- Server address
- Authentication server name
- User name and password for proxy logins

The package of Mirror information sent from the DHCP server in the Option 43 packet can include the:

- Server address
- Mirror path
- Mirror feedback path
- Mirror appl path
- Mirror mode

Type `setvar;getvar`

Supported Devices

- iMZ™ series
- QLn™ series
- ZT200™ series
- ZT400™ series

Commands	Details
setvar	This command enables or disables the DHCP auto provision feature of the printer. <i>Format:</i> ! U1 setvar "ip.dhcp.auto_provision_enable" "value" <i>Values:</i> "on" = enabled "off" = disabled <i>Default:</i> "off"
getvar	This command retrieves the current value of on or off for the DHCP auto provision feature. <i>Format:</i> ! U1 getvar "ip.dhcp.auto_provision_enable"



Note •

- For printer support, see [SGD Command Support](#) on page 1267.
- For details on SGD command structure, see [Command Structure](#) on page 635.

ip.dhcp.cache_ip

Description This command enables or disables the IP caching.

Type setvar;setvar

Commands	Details
setvar	<p>This command sets the status of the IP cache.</p> <p><i>Format:</i> ! U1 setvar "ip.dhcp.cache_ip" "value"</p> <p><i>Values:</i></p> <ul style="list-style-type: none"> "on" = enabled "off" = disabled <p><i>Default:</i> "off"</p>
getvar	<p>This command retrieves the status of the IP cache.</p> <p><i>Format:</i> ! U1 getvar "ip.dhcp.cache_ip"</p>



Example • This `setvar` example shows the value set to "off".

```
! U1 setvar "ip.dhcp.cache_ip" "off"
```

When the `setvar` value is set to "off", the `getvar` result is "off".



Note •

- For printer support, see [SGD Command Support on page 1267](#).
- For details on SGD command structure, see [Command Structure on page 635](#).

ip.dhcp.cid_all

Description This printer setting defines the entire client identifier (DHCP option 61) if the DHCP is enabled and "ip.dhcp.cid_type" is set to "0", or "2". The MAC address is used if the type is set to "1".

Type setvar;getvar

Commands	Details
setvar	This command instructs the printer to change the CID prefix and suffix. <i>Format:</i> ! U1 setvar "ip.dhcp.cid_all" "value" <i>Values:</i> A maximum length of 60 characters if the CID type is ASCII, or 120 characters if the CID type is hexadecimal. <i>Default Value:</i> ""
getvar	This command instructs the printer to respond with the client identifier prefix and suffix. <i>Format:</i> ! U1 getvar "ip.dhcp.cid_all"



Example • This `setvar` example shows the value set to "printer".

```
! U1 setvar "ip.dhcp.cid_all" "printer"
```

What the `setvar` value is set to is the `getvar` result. In this example, the `getvar` result is "printer".



Note •

- For printer support, see [SGD Command Support on page 1267](#).
- For details on SGD command structure, see [Command Structure on page 635](#).

ip.dhcp.cid_enable

Description This command determines if DHCP (option 61) is turned on or off.

Type setvar;setvar

Commands	Details
setvar	<p>This command instructs the printer to set the status of the client identifier.</p> <p><i>Format:</i> ! U1 setvar "ip.dhcp.cid_enable" "value"</p> <p><i>Values:</i></p> <p> "off" = client identifier is turned off</p> <p> "on" = client identifier is turned on</p> <p><i>Default:</i> "off"</p>
getvar	<p>This command instructs the printer to respond with the status of the client identifier.</p> <p><i>Format:</i> ! U1 getvar "ip.dhcp.cid_enable"</p>



Example • This `setvar` example shows the value set to "off".

```
! U1 setvar "ip.dhcp.cid_enable" "off"
```

What the `setvar` value is set to is the `getvar` result. In this example, the `getvar` result is "off".



Note •

- For printer support, see [SGD Command Support on page 1267](#).
- For details on SGD command structure, see [Command Structure on page 635](#).

ip.dhcp.cid_prefix

Description This printer setting defines the prefix to be prepended to the DHCP client identifier (option 61) when DHCP is enabled and "ip.dhcp.cid_type" is set to "0" or "2".

Type setvar;getvar

Commands	Details
setvar	This command instructs the printer to change the CID prefix. <i>Format:</i> ! U1 setvar "ip.dhcp.cid_prefix" "value" <i>Values:</i> Any text string up to 10 characters if the CID type is ASCII, or 20 characters if the CID type is hexadecimal. <i>Default Value:</i> ""
getvar	This command instructs the printer to respond with the client identifier prefix. <i>Format:</i> ! U1 getvar "ip.dhcp.cid_prefix"



Example • This `setvar` example sets the value to "ZEB".

```
! U1 setvar "ip.dhcp.cid_prefix" "ZEB"
```

What the `setvar` value is set to is the `getvar` result. In this example, the `getvar` result is "ZEB".

The next time the printer sends a DHCP request, if `ip.dhcp.cid_type` is "0", the client identifier sent will be prefixed with the string "ZEB". For example, if `ip.dhcp.cid_value` is "PRT001", the actual client identifier sent will be "ZEBPRT001"



Note •

- For printer support, see [SGD Command Support on page 1267](#).
- For details on SGD command structure, see [Command Structure on page 635](#).

ip.dhcp.cid_suffix

Description This printer setting defines the unique suffix to be used as the client identifier (DHCP option 61) if DHCP is enabled and "ip.dhcp.cid_type" is set to "0" or "2".

Type setvar;getvar

Commands	Details
setvar	This command instructs the printer to change the CID value. <i>Format:</i> ! U1 setvar "ip.dhcp.cid_suffix" "value" <i>Values:</i> The maximum length of a value allowed is 60 ASCII characters when the CID type is ASCII, or 120 hexadecimal values when the CID type is hexadecimal. <i>Default Value:</i> ""
getvar	This command instructs the printer to respond with the client identifier suffix. <i>Format:</i> ! U1 getvar "ip.dhcp.cid_suffix"



Example • This `setvar` example shows the value set to "printer".

```
! U1 setvar "ip.dhcp.cid_suffix" "printer"
```

What the `setvar` value is set to is the `getvar` result. In this example, the `getvar` result is "printer".



Note •

- For printer support, see [SGD Command Support on page 1267](#).
- For details on SGD command structure, see [Command Structure on page 635](#).

ip.dhcp.cid_type

Description This printer setting defines the type of client identifier (DHCP option 61) that will be sent if DHCP is enabled. A value of "1" means the type of "Ethernet" and the printer's MAC address will be used. A value of "0" or "2" means the client identifier sent will be "ip.dhcp.cid_prefix" concatenated with "ip.dhcp.cid_suffix".

Type setvar;setvar

Commands	Details
setvar	This command instructs the printer to set the Client Identifier type. <i>Format:</i> ! U1 setvar "ip.dhcp.cid_type" "value" <i>Values:</i> "0" = ASCII string "1" = wireless radio card's MAC address "2" = HEX value <i>Default Value:</i> "1"
getvar	This command instructs the printer to respond with the client identifier type. <i>Format:</i> ! U1 getvar "ip.dhcp.cid_type"



Example • This `setvar` example shows the value set to "1".

```
! U1 setvar "ip.dhcp.cid_type" "1"
```

When the `setvar` value is set to "1", the `getvar` result is "1".



Note •

- For printer support, see [SGD Command Support on page 1267](#).
- For details on SGD command structure, see [Command Structure on page 635](#).

ip.dhcp.cid_value

Description This parameter defines the unique value to be used as the client identifier (option 61) if DHCP is enabled and “ip.dhcp.cid_type” is “1”.



Note • This parameter is only applicable if [ip.dhcp.cid_enable](#) is set to “on”.

Type `setvar;getvar`

Commands	Details
<code>setvar</code>	<p>This command instructs the printer to change the CID value.</p> <p><i>Format:</i> <code>! U1 setvar "ip.dhcp.cid_value" "value"</code></p> <p><i>Values:</i> Any text string up to 20 characters in length.</p> <p><i>Default Value:</i></p> <p>If ip.dhcp.cid_type is set to:</p> <ul style="list-style-type: none"> • "0" — the default is the printer’s friendly name (see device.friendly_name on page 702). • "1" — the default is the printer’s MAC address.
<code>getvar</code>	<p>This command instructs the printer to respond with the client identifier value.</p> <p><i>Format:</i> <code>! U1 getvar "ip.dhcp.cid_value"</code></p>



Example • This `setvar` example changes the cid value to "PRT001".

```
! U1 setvar "ip.dhcp.cid_value" "PRT001"
```

The next time the printer sends a DHCP request, if [ip.dhcp.cid_type](#) is "0", the client identifier sent will be [ip.dhcp.cid_prefix](#) plus "PRT001". For example, if [ip.dhcp.cid_prefix](#) is "ZEB", the actual client identifier sent will be "ZEBPRT001"



Note •

- For printer support, see [SGD Command Support](#) on page 1267.
- For details on SGD command structure, see [Command Structure](#) on page 635.

ip.dhcp.enable

Definition This printer setting turns DHCP on or off. DHCP is a method for acquiring an IP address, netmask, and gateway automatically on printer power-up. It requires a DHCP server on the local network.



Note • If you are using static IP addressing, the IP protocol must be set to permanent.

Type setvar;getvar

Commands	Details
setvar	This command instructs the printer to turn DHCP on or off. <i>Format:</i> ! U1 setvar "ip.dhcp.enable" "value" <i>Values:</i> "off" = printer does not use DHCP to get the IP address "on" = printer uses DHCP to get the IP address <i>Default:</i> "on"
getvar	This command instructs the printer to respond with the DHCP status. <i>Format:</i> ! U1 getvar "ip.dhcp.enable"



Example • This setvar example shows the value set to "on".

```
! U1 setvar "ip.dhcp.enable" "on"
```

When the setvar value is set to "on", the getvar result is "on".



Note •

- For printer support, see [SGD Command Support on page 1267](#).
- For details on SGD command structure, see [Command Structure on page 635](#).

ip.dhcp.lease.last_attempt

Description This command retrieves the time from the DHCP server of when the last DHCP request was sent.

Type `getvar`

Commands	Details
<code>getvar</code>	This command retrieves the last time a DHCP request was sent. <i>Format:</i> <code>! U1 getvar "ip.dhcp.lease.last_attempt"</code>



Example • In this example, the `getvar` retrieves the last time a DHCP request was sent to the wireless print server.

```
! U1 getvar "ip.dhcp.lease.last_attempt"
```



Note •

- For printer support, see [SGD Command Support on page 1267](#).
- For details on SGD command structure, see [Command Structure on page 635](#).

ip.dhcp.lease.server

Description This command retrieves the address of the server that provided the DHCP lease on the wireless print server.

Type `getvar`

Commands	Details
<code>getvar</code>	This command retrieves the address of the server that provided the DHCP lease on the wireless print server. <i>Format:</i> <code>! U1 getvar "ip.dhcp.lease.server"</code>



Example • In this example, the `getvar` retrieves the server that provided the DHCP lease on the wireless print server.

```
! U1 getvar "ip.dhcp.lease.server"
```

```
"10.3.5.1"
```



Note •

- For printer support, see [SGD Command Support on page 1267](#).
- For details on SGD command structure, see [Command Structure on page 635](#).

ip.dhcp.lease.time_left

Description This command retrieves the time left in the current DHCP lease on the wireless print server.

Type `getvar`

Commands	Details
<code>getvar</code>	This command retrieves the time left in the current DHCP lease on the wireless print server. <i>Format:</i> <code>! U1 getvar "ip.dhcp.lease.time_left"</code>



Example • In this example, the `getvar` retrieves the time left in the current DHCP lease on the wireless print server.

```
! U1 getvar "ip.dhcp.lease.time_left"

"1192518"
```



Note •

- For printer support, see [SGD Command Support on page 1267](#).
- For details on SGD command structure, see [Command Structure on page 635](#).

ip.dhcp.option12

Description This command specifies if the DHCP option 12 (host name) is on or off in the discovery packet that is sent from the wireless print server.

Type setvar;getvar

Commands	Details
setvar	<p>This command instructs the printer to set the DHCP option 12 (host name) in the discovery packet that is sent from the wireless print server.</p> <p><i>Format:</i> ! U1 setvar "ip.dhcp.option12" "value"</p> <p><i>Values:</i></p> <ul style="list-style-type: none">"on" = turns on option 12"off" = turns off option 12 <p><i>Default Value:</i> "on"</p>
getvar	<p>This command retrieves the status of the DHCP option 12 (host name) in the discovery packet that is sent from the wireless print server.</p> <p><i>Format:</i> ! U1 getvar "ip.dhcp.option12"</p>



Example • This `setvar` example shows the value set to "on".

```
! U1 setvar "ip.dhcp.option12" "on"
```

When the `setvar` value is set to "on", the `getvar` result is "on".



Note •

- For printer support, see [SGD Command Support on page 1267](#).
- For details on SGD command structure, see [Command Structure on page 635](#).

ip.dhcp.option12_format

Description This command specifies the value which will be used for option 12 (host name) to be used in the DHCP discovery packet of the wireless print server.

Type setvar;getvar

Commands	Details
setvar	This command instructs the printer to set the value which will be used for option 12 (host name) to be used in the DHCP discovery packet of the wireless print server. <i>Format:</i> ! U1 setvar "ip.dhcp.option12_format" "value" <i>Values:</i> string <i>Default Value:</i> ""
getvar	This command retrieves the value which will be used for option 12 (host name) to be used in the DHCP discovery packet of the wireless print server. <i>Format:</i> ! U1 getvar "ip.dhcp.option12_format"



Example • This `setvar` example shows configuring the `ip.dhcp.option12_format` to the value contained in the `device.friendly_name`.

It is necessary to surround the SGD entry to be used as source for the data with the `<` and `>` characters.

```
! U1 setvar "ip.dhcp.option12_format" "<device.friendly_name>"
```

To further explain, if the above command was issued and the value currently stored in the `device.friendly_name` parameter was "ShipPrinter", then the response to following command would be "ShipPrinter":

```
! U1 getvar "ip.dhcp.option12_value"
```



Note •

- For printer support, see [SGD Command Support on page 1267](#).
- For details on SGD command structure, see [Command Structure on page 635](#).

ip.dhcp.option12_value

Description This command retrieves the actual value which will be used in the discovery packet of the wireless print server.

Type `getvar`

Commands	Details
<code>getvar</code>	This command retrieves the actual value which will be used in the discovery packet of the wireless print server. <i>Format: ! U1 getvar "ip.dhcp.option12_value"</i>



Example • This `setvar` example shows configuring the `ip.dhcp.option12_format` to the value contained in the `device.friendly_name`.

It is necessary to surround the SGD entry to be used as source for the data with the `<` and `>` characters.

```
! U1 setvar "ip.dhcp.option12_format" "<device.friendly_name>"
```

To further explain, if the above command was issued and the value currently stored in the `device.friendly_name` parameter was "ShipPrinter", then the response to following command would be "ShipPrinter":

```
! U1 getvar "ip.dhcp.option12_value"
```



Note •

- For printer support, see [SGD Command Support on page 1267](#).
- For details on SGD command structure, see [Command Structure on page 635](#).

ip.dhcp.request_timeout

Description This command retrieves the maximum amount of time (in seconds) for a DHCP discovery requests on the wireless print server.

Type setvar;getvar

Commands	Details
setvar	This command instructs the printer to set the amount of time (in seconds) to wait before timing out a DHCP discovery request. <i>Format:</i> ! U1 setvar "ip.dhcp.request_timeout" "value" <i>Values:</i> "2" through "30" <i>Default:</i> "2"
getvar	This command retrieves the currently set the amount of time (in seconds) to wait before timing out a DHCP discovery request. <i>Format:</i> ! U1 getvar "ip.dhcp.request_timeout"



Example • This `setvar` example shows the value set to "2".

```
! U1 setvar "ip.dhcp.request_timeout" "2"
```

When the `setvar` value is set to "2", the `getvar` result is "2".



Note •

- For printer support, see [SGD Command Support on page 1267](#).
- For details on SGD command structure, see [Command Structure on page 635](#).

ip.dhcp.requests_per_session

Description This command retrieves the maximum amount of DHCP discovery requests for a single DHCP session on the wireless print server.

Type setvar;getvar

Commands	Details
setvar	This command instructs the printer to set the maximum amount of DHCP discovery requests for a single DHCP session on the wireless print server. <i>Format:</i> ! U1 setvar "ip.dhcp.requests_per_session" "value" <i>Values:</i> "1" through "10" <i>Default:</i> "2"
getvar	This command retrieves the currently set maximum amount of DHCP discovery requests for a single DHCP session on the wireless print server. <i>Format:</i> ! U1 getvar "ip.dhcp.requests_per_session"



Example • This `setvar` example shows the value set to "2".
! U1 setvar "ip.dhcp.requests_per_session" "2"
When the `setvar` value is set to "2", the `getvar` result is "2".



Note •

- For printer support, see [SGD Command Support on page 1267](#).
- For details on SGD command structure, see [Command Structure on page 635](#).

ip.dhcp.session_interval

Description This command configures the time interval (in seconds) before a new DHCP session is started on the wireless print server.

Type setvar;getvar

Commands	Details
setvar	This command instructs the printer to set the DHCP session time out value (in seconds). <i>Format:</i> ! U1 setvar "ip.dhcp.session_interval" "value" <i>Values:</i> "0" through "60" <i>Default:</i> "10"
getvar	This command retrieves the current DHCP session time out value (in seconds). <i>Format:</i> ! U1 getvar "ip.dhcp.session_interval"



Example • This `setvar` example shows the value set to "10".

```
! U1 setvar "ip.dhcp.session_interval" "10"
```

When the `setvar` value is set to "10", the `getvar` result is "10".



Note •

- For printer support, see [SGD Command Support](#) on page 1267.
- For details on SGD command structure, see [Command Structure](#) on page 635.

ip.dhcp.vendor_class_id

Description This command configures the DHCP vendor class ID setting.

Type setvar;getvar

Supported Devices

- iMz™ series
- QLn™ series
- ZT200™ series
- ZD500R™ series

Commands	Details
setvar	<p>This command sets the DHCP vendor class ID setting.</p> <p><i>Format:</i> ! U1 setvar "ip.dhcp.vendor_class_id" "value"</p> <p><i>Values:</i> Max string length of 64.</p> <p>This command builds a string using the following values: (device.company_name) (device.product_name)- (head.resolution.in_dpi) (device.pnp_option)</p> <p><i>Default:</i> The default varies by printer.</p>
getvar	<p>This command retrieves the current DHCP vendor class ID setting.</p> <p><i>Format:</i> ! U1 getvar "ip.dhcp.vendor_class_id"</p>



Example • For a Zebra ZT230 printer set at 203dpi, the result would be:
 Zebra Technologies ZTC ZT230-2003dpi ZPL



Note •

- For printer support, see [SGD Command Support on page 1267](#).
- For details on SGD command structure, see [Command Structure on page 635](#).

ip.dns.domain

Description This command identifies the network domain of the wireless print server.

Type `getvar`

Commands	Details
<code>getvar</code>	This command retrieves the network domain of the wireless print server. <i>Format:</i> <code>! U1 getvar "ip.dns.domain"</code>



Example • In this example, the `getvar` retrieves the network domain of the wireless print server.

```
! U1 getvar "ip.dns.domain"
```



Note •

- For printer support, see [SGD Command Support on page 1267](#).
- For details on SGD command structure, see [Command Structure on page 635](#).

ip.dns.servers

Description This command retrieves a space delimited list of the domain name servers from a wireless print server.

Type `getvar`

Commands	Details
<code>getvar</code>	This command retrieves a list of space delimited DNS wireless print servers. <i>Format:</i> <code>! U1 getvar "ip.dns.servers"</code>



Example • In this example, the `getvar` retrieves a list of space delimited DNS wireless print servers.

```
! U1 getvar "ip.dns.servers"
```



Note •

- For printer support, see [SGD Command Support on page 1267](#).
- For details on SGD command structure, see [Command Structure on page 635](#).

ip.ftp.enable

Description This printer setting refers to the FTP protocol setting. This command tells the printer to turn FTP on or off.

Type setvar;getvar

Commands	Details
setvar	<p>This command instructs the printer to turn FTP on or off.</p> <p><i>Format:</i> ! U1 setvar "ip.ftp.enable" "value"</p> <p><i>Values:</i></p> <ul style="list-style-type: none"> "off" = disables FTP "on" = enables FTP <p><i>Default:</i> "on"</p>
getvar	<p>This command instructs the printer to respond with the FTP status.</p> <p><i>Format:</i> ! U1 getvar "ip.ftp.enable"</p>



Example • This `setvar` example shows the FTP status set to "on".

```
! U1 setvar "ip.ftp.enable" "on"
```

When the `setvar` value is set to "on", the `getvar` result is that the FTP status is "on".



Note •

- For printer support, see [SGD Command Support on page 1267](#).
- For details on SGD command structure, see [Command Structure on page 635](#).

ip.ftp.execute_file

Description This command setting controls the printers' ability to process or not process commands received via the FTP protocol using the printers ZPL engine.

Type setvar;setvar

Commands	Details
setvar	This command instructs the printer to turn FTP processing ability on or off. <i>Format:</i> ! U1 setvar "ip.ftp.execute_file" "value" <i>Values:</i> "off" = disables the printer's ability to process FTP commands "on" = enables the printer's ability to process FTP commands <i>Default:</i> "on"
getvar	This command instructs the printer to respond with the FTP processing ability status. <i>Format:</i> ! U1 getvar "ip.ftp.execute_file"



Example • This setvar example shows the FTP processing ability set to "on".

```
! U1 setvar "ip.ftp.execute_file" "on"
```



Note •

- For printer support, see [SGD Command Support on page 1267](#).
- For details on SGD command structure, see [Command Structure on page 635](#).

ip.ftp.request_password

Description This command controls whether the ftp client will prompt the user to enter a password at the beginning of an ftp session.

Supported Devices ZT200 Series

Type setvar;setvar

Commands	Details
setvar	<p>This command instructs the printer to turn on or off the ftp session password request.</p> <p><i>Format:</i> ! U1 setvar "ip.ftp.request_password" "value"</p> <p><i>Values:</i></p> <p>"no"</p> <p>"yes"</p> <p><i>Default:</i> "no"</p>
getvar	<p>This command returns whether the ftp client is set to prompt the user for a password at the start of an ftp session.</p> <p><i>Format:</i> ! U1 getvar "ip.ftp.request_password"</p>



Example • This `setvar` example shows the value set to "yes".

```
! U1 setvar "ip.ftp.request_password" "yes"
```



Note •

- For printer support, see [SGD Command Support on page 1267](#).
- For details on SGD command structure, see [Command Structure on page 635](#).

ip.gateway

Description This command instructs the printer to change the gateway address.



Important • This setting refers to the gateway address. A set value is ignored if the IP protocol is not set to permanent.

Type setvar;getvar

Commands	Details
setvar	This command instructs the printer to change the gateway address. <i>Format:</i> ! U1 setvar "ip.gateway" "value" <i>Values:</i> Any valid gateway address <i>Default:</i> "0.0.0.0"
getvar	This command instructs the printer to respond with the gateway address. <i>Format:</i> ! U1 getvar "ip.gateway"



Example • This `setvar` example shows the value set to "10.3.5.1".

```
! U1 setvar "ip.gateway" "10.3.5.1"
```

When the `setvar` value is set to "10.3.5.1", the `getvar` result is "10.3.5.1".



Note •

- For printer support, see [SGD Command Support on page 1267](#).
- For details on SGD command structure, see [Command Structure on page 635](#).

ip.http.admin_name

Description This command sets the name to be used for authentication on the print server web pages.

Supported Devices ZT200 Series

Type setvar;setvar

Commands	Details
setvar	This command instructs the printer to set the admin user name to the specified value. <i>Format:</i> ! U1 setvar "ip.http.admin_name" "value" <i>Values:</i> a string with a maximum of 25 characters <i>Default:</i> "admin"
getvar	This command instructs the printer to respond with the admin user name. <i>Format:</i> ! U1 getvar "ip.http.admin_name" <i>Result:</i> A user name



Example • This `setvar` example shows the value set to "useradmin101".
! U1 setvar "ip.http.admin_name" "useradmin101"



Note •

- For printer support, see [SGD Command Support on page 1267](#).
- For details on SGD command structure, see [Command Structure on page 635](#).

ip.http.admin_password

Description This command sets the password to be used for authentication on the print server web pages.

Supported Devices ZT200 Series

Type setvar;setvar

Commands	Details
setvar	This command instructs the printer to set print server web page password. <i>Format:</i> ! U1 setvar "ip.http.admin_password" "value" <i>Values:</i> a string, maximum 25 characters <i>Default:</i> 1234
getvar	This command instructs the printer to respond with the print server web page password. <i>Format:</i> ! U1 getvar "ip.http.admin_password"



Example • This `setvar` example shows the value set to "P@ssword101".

```
! U1 setvar "ip.http.admin_password" "P@ssword101"
```



Note •

- For printer support, see [SGD Command Support on page 1267](#).
- For details on SGD command structure, see [Command Structure on page 635](#).

ip.http.custom_link_name

Description This command creates a custom link below the FAQ link on the print server settings page. Use [ip.http.custom_link_url on page 1022](#) to define the URL for your link name.

Supported Devices ZT200 Series

Type setvar;setvar

Commands	Details
setvar	This command instructs the printer to set the custom link name. <i>Format:</i> ! U1 setvar "ip.http.custom_link_name" "value" <i>Values:</i> Any string, maximum of 25 characters <i>Default:</i> ""
getvar	This command instructs the printer to respond with the custom link name. <i>Format:</i> ! U1 getvar "ip.http.custom_link_name"



Example • This `setvar` example shows the value set to "Click Here for Info".

```
! U1 setvar "ip.http.custom_link_name" "Click Here for Info"
```



Note •

- For printer support, see [SGD Command Support on page 1267](#).
- For details on SGD command structure, see [Command Structure on page 635](#).

ip.http.custom_link_url

Description This command creates a custom link on the printer web page for the printer's URL. Use [ip.http.custom_link_name](#) on page 1021 to define the text that will display for your link.

Supported Devices ZT200 Series

Type setvar;setvar

Commands	Details
setvar	This command instructs the printer to change the custom URL. <i>Format:</i> ! U1 setvar "ip.http.custom_link_url" "value" <i>Values:</i> A string of 64 characters or less <i>Default:</i> ""
getvar	This command instructs the printer to respond with the custom URL. <i>Format:</i> ! U1 getvar "ip.http.custom_link_url"



Example •

```
! U1 setvar "ip.http.custom_link_url" "http://www.zebra.com/sdk"
```



Note •

- For printer support, see [SGD Command Support](#) on page 1267.
- For details on SGD command structure, see [Command Structure](#) on page 635.

ip.http.enable

Description This printer setting refers to the HTTP protocol/web server setting.

Type setvar;setvar

Commands	Details
setvar	This command instructs the printer to change HTTP to on or off. <i>Format:</i> ! U1 setvar "ip.http.enable" "value" <i>Values:</i> "off" = disables HTTP protocol "on" = enables HTTP protocol <i>Default:</i> "on"
getvar	This command instructs the printer to respond with the HTTP status. <i>Format:</i> ! U1 getvar "ip.http.enable"



Example • This `setvar` example shows the value set to "on".

```
! U1 setvar "ip.http.enable" "on"
```

When the `setvar` value is set to "on", the `getvar` result is "on".



Note •

- For printer support, see [SGD Command Support on page 1267](#).
- For details on SGD command structure, see [Command Structure on page 635](#).

ip.http.faq_url

Description This command sets the FAQ URL displayed on the printer web pages.

Supported Devices ZT200 Series

Type setvar;setvar

Commands	Details
setvar	This command instructs the printer to change the FAQ URL. <i>Format:</i> ! U1 setvar "ip.http.faq_url" "value" <i>Values:</i> A string of 64 characters or less. <i>Default:</i> ""
getvar	This command instructs the printer to respond with the current FAQ URL. <i>Format:</i> ! U1 getvar "ip.http.faq_url"



Example •

```
! U1 setvar "ip.http.faq_url" "http://www.yoursite.com/faq"
```



Note •

- For printer support, see [SGD Command Support on page 1267](#).
- For details on SGD command structure, see [Command Structure on page 635](#).

ip.http.port

Description This command sets the port number at which the printer web pages will be served.

Supported Devices ZT200 Series

Type setvar;setvar

Commands	Details
setvar	This command instructs the printer to change the port setting for the printer web pages. <i>Format:</i> ! U1 setvar "ip.http.port" "value" <i>Values:</i> "0" to "65535" <i>Default:</i> "80"
getvar	This command instructs the printer to respond with the current port setting for the printer web pages. <i>Format:</i> ! U1 getvar "ip.http.port"



Example • This `setvar` example shows the value set to "8080".

```
! U1 setvar "ip.http.enable" "8080"
```



Note •

- For printer support, see [SGD Command Support on page 1267](#).
- For details on SGD command structure, see [Command Structure on page 635](#).

ip.lpd.enable

Description This printer setting refers to the LPD (Line Printer Daemon) protocol setting.



Important • LPD communications from the host should be directed to port 515.

Type setvar;getvar

Commands	Details
setvar	This command instructs the printer to turn LPD on or off. <i>Format:</i> ! U1 setvar "ip.lpd.enable" "value" <i>Values:</i> "off" = disables LPD protocol "on" = enables LPD protocol <i>Default:</i> "on"
getvar	This command instructs the printer to respond with the LPD status. <i>Format:</i> ! U1 getvar "ip.lpd.enable"



Example • This `setvar` example shows the value set to "on".

```
! U1 setvar "ip.lpd.enable" "on"
```

When the `setvar` value is set to "on", the `getvar` result is "on".



Note •

- For printer support, see [SGD Command Support on page 1267](#).
- For details on SGD command structure, see [Command Structure on page 635](#).

ip.mac_raw

Description This command specifies the RAW MAC address of the wireless print server. The raw mac address is the mac address without the colons (":").

Type `getvar`

Commands	Details
<code>getvar</code>	This command retrieves the RAW MAC address of the wireless print server. <i>Format: ! U1 getvar "ip.mac_raw"</i>



Example • In this example, the `getvar` retrieves the RAW MAC address of the wireless print server.

```
! U1 getvar "ip.mac_raw"
```



Note •

- For printer support, see [SGD Command Support on page 1267](#).
- For details on SGD command structure, see [Command Structure on page 635](#).

ip.mirror.appl_path



Description This command overrides the default location of the mirror application path ("appl" in "ip.mirror.path"). If the SGD is empty, the default path is used. If an error occurs retrieving application from path (i.e. path not found or application not there), the default path is NOT used. This path must be fully defined in relation to the mirror server root and is not relative to [ip.mirror.path](#).

Type setvar;getvar

Supported Devices

- iMz™ series
- QLn™ series
- ZT200™ series
- ZD500R™ series

Commands	Details
setvar	This command sets the path to the application on the mirror server. <i>Format: ! U1 setvar "ip.mirror.appl_path" "values"</i> <i>Values: A valid application path (location)</i> <i>Default Value: ""</i>
getvar	This command retrieves the path to the application on the mirror server. <i>Format: ! U1 getvar "ip.mirror.appl_path"</i>



Example • If the default value is used, the application would be copied from "ip.mirror.path"\appl
If you send ! U1 setvar "ip.mirror.appl_path" "program\current" and "ip.mirror.path" has the value "c:\mirror", then the application would be copied from c:\mirror\program\current.



Note •

- For printer support, see [SGD Command Support on page 1267](#).
- For details on SGD command structure, see [Command Structure on page 635](#).

ip.mirror.auto



Description This command enables the ability to automatically perform a mirror update (fetch) command on power up.

Type setvar;setvar

Commands	Details
setvar	<p>This command instructs the printer to perform a mirror update (fetch) command when the printer is turned on using the interval that is set for "ip.mirror.freq" or "ip.mirror.freq_hours".</p> <p><i>Format:</i> ! U1 setvar "ip.mirror.auto" "values"</p> <p><i>Values:</i></p> <ul style="list-style-type: none"> "on" = turns on the auto mirroring feature "off" = turns off the auto mirroring feature <p><i>Default Value:</i> "off"</p>
getvar	<p>This command will report whether the printer will perform a mirror update (fetch) automatically on power up.</p> <p><i>Format:</i> ! U1 getvar "ip.mirror.auto"</p>



Example • This setvar example shows the value set to "off".

```
! U1 setvar "ip.mirror.auto" "off"
```

When the setvar value is set to "off", the getvar result is "off".



Note •

- For printer support, see [SGD Command Support on page 1267](#).
- For details on SGD command structure, see [Command Structure on page 635](#).

ip.mirror.error_retry



Description This command identifies how many times mirroring is retried when an error occurs.

Type setvar;getvar

Commands	Details
setvar	This command instructs the printer to set the required times that mirroring retries when an error occurs. <i>Format:</i> ! U1 setvar "ip.mirror.error_retry" "value" <i>Values:</i> numeric values (0 - 65535) <i>Default Value:</i> "0"
getvar	This command retrieves the number of times the printer retries mirroring when an error occurs. <i>Format:</i> ! U1 getvar "ip.mirror.error_retry"



Example • This `setvar` example shows the value set to "0".

```
! U1 setvar "ip.mirror.error_retry" "0"
```

When the `setvar` value is set to "0", the `getvar` result is "0".



Note •

- For printer support, see [SGD Command Support on page 1267](#).
- For details on SGD command structure, see [Command Structure on page 635](#).

ip.mirror.feedback.auto



Description This command identifies if a feedback file is pushed to the mirroring server by the printer when a mirroring update (fetch) is complete.

Type setvar;getvar

Commands	Details
setvar	<p>This command instructs the printer to set the mirror feedback feature to on or off.</p> <p><i>Format:</i> ! U1 setvar "ip.mirror.feedback.auto" "value"</p> <p><i>Values:</i></p> <ul style="list-style-type: none"> "on" = turns on mirror feedback "off" = turns off mirror feedback <p><i>Default Value:</i> "off"</p>
getvar	<p>This command retrieves the mirror feedback setting that the printer is currently using.</p> <p><i>Format:</i> ! U1 getvar "ip.mirror.feedback.auto"</p>



Example • This setvar example shows the value set to "off".

```
! U1 setvar "ip.mirror.feedback.auto" "off"
```

When the setvar value is set to "off", the getvar result is "off".



Note •

- For printer support, see [SGD Command Support on page 1267](#).
- For details on SGD command structure, see [Command Structure on page 635](#).

ip.mirror.feedback.freq



Description This command specifies the time interval (in minutes) between performing feedback file uploads.

Type setvar;getvar

Commands	Details
setvar	This command instructs the printer to set the number of minutes to wait between feedback file uploads. <i>Format:</i> ! U1 setvar "ip.mirror.feedback.freq" "value" <i>Values:</i> numeric value (0 - 65535) <i>Default Value:</i> "0"
getvar	This command retrieves the number of minutes set to wait between feedback file uploads. <i>Format:</i> ! U1 getvar "ip.mirror.feedback.freq"



Example • This `setvar` example shows the value set to "0".

```
! U1 setvar "ip.mirror.feedback.freq" "0"
```

When the `setvar` value is set to "0", the `getvar` result is "0".



Note •

- For printer support, see [SGD Command Support on page 1267](#).
- For details on SGD command structure, see [Command Structure on page 635](#).

ip.mirror.feedback.odometer



Description This command instructs the printer to set the mirror feedback odometer.

Type setvar;getvar

Commands	Details
setvar	This command instructs the printer to set the odometer counter. <i>Format:</i> ! U1 setvar "ip.mirror.feedback.odometer" "values" <i>Values:</i> numeric value between 0 and 2632 <i>Default Value:</i> "0"
getvar	This command retrieves the mirror feedback odometer. <i>Format:</i> ! U1 getvar "ip.mirror.feedback.odometer"



Example • This `setvar` example shows the value set to "0".
! U1 setvar "ip.mirror.feedback.odometer" "0"
When the `setvar` value is set to "0", the `getvar` result is "0".



Note •

- For printer support, see [SGD Command Support on page 1267](#).
- For details on SGD command structure, see [Command Structure on page 635](#).

ip.mirror.feedback.path



Description This command identifies where the feedback file is stored on the mirroring server.

Type setvar;getvar

Commands	Details
setvar	This command instructs the printer to set the path on the mirroring server that stores the feedback file. <i>Format:</i> ! U1 setvar "ip.mirror.feedback.path" "value" <i>Values:</i> alphanumeric text (1 to 50 characters) <i>Default Value:</i> "Zebra/feedback"
getvar	This command retrieves the path on the mirroring sever that the printer is currently using to store the feedback file. <i>Format:</i> ! U1 getvar "ip.mirror.feedback.path"



Example • This `setvar` example shows the value set to "Zebra/feedback".

```
! U1 setvar "ip.mirror.feedback.path" "Zebra/feedback"
```

When the `setvar` value is set to "Zebra/feedback", the `getvar` result is "Zebra/feedback".



Note •

- For printer support, see [SGD Command Support on page 1267](#).
- For details on SGD command structure, see [Command Structure on page 635](#).

ip.mirror.fetch



Description This command forces a mirroring update sequence.

Type setvar;do

Commands	Details
setvar	This command forces a mirroring update sequence. <i>Format:</i> ! U1 setvar "ip.mirror.fetch" ""
do	This command forces a mirroring update sequence. <i>Format:</i> ! U1 do "ip.mirror.fetch" ""



Example • This `setvar` example forces a mirroring update sequence.

```
! U1 setvar "ip.mirror.fetch" ""
```



Note •

- For printer support, see [SGD Command Support on page 1267](#).
- For details on SGD command structure, see [Command Structure on page 635](#).

ip.mirror.freq



Description This command defines the frequency of mirroring updates (in minutes).

Type setvar;getvar

Commands	Details
setvar	<p>This command instructs the printer to set the mirror frequency.</p> <p><i>Format:</i> ! U1 setvar "ip.mirror.freq" "value"</p> <p><i>Values:</i> "0" through "65535" (minutes)</p> <p><i>Default Value:</i> "0" (disables this feature)</p> <p> Important • When the "ip.mirror.freq" is set to a low value (other than zero) the printer will spend a lot of time performing the mirroring process.</p>
getvar	<p>This command retrieves the number of minutes to wait before performing another mirror update.</p> <p><i>Format:</i> ! U1 getvar "ip.mirror.freq"</p>



Example • This setvar example shows the value set to "1000".

```
! U1 setvar "ip.mirror.freq" "1000"
```

When the setvar value is set to "1000", the getvar result is "1000" and mirroring will be attempted every 1000 minutes.



Note •

- For printer support, see [SGD Command Support on page 1267](#).
- For details on SGD command structure, see [Command Structure on page 635](#).

ip.mirror.freq_hours



Description This command defines the frequency of mirroring updates (in hours).

Type setvar;getvar

Commands	Details
setvar	This command instructs the printer to set the frequency of mirroring updates (in hours). <i>Format:</i> ! U1 setvar "ip.mirror.freq_hours" "values" <i>Values:</i> "0" through "100" <i>Default Value:</i> "0" (disables this feature)
getvar	This command retrieves the frequency of mirroring updates (in hours) that the printer is currently using. <i>Format:</i> ! U1 getvar "ip.mirror.freq_hours"



Example • This `setvar` example shows the value set to "8".

```
! U1 setvar "ip.mirror.freq_hours" "8"
```

When the `setvar` value is set to "8", the `getvar` result is "8" and mirroring will be attempted every 8 hours.



Note •

- For printer support, see [SGD Command Support on page 1267](#).
- For details on SGD command structure, see [Command Structure on page 635](#).

ip.mirror.last_error



Description This command retrieves the last error encountered during a mirroring operation.

Type `getvar`

Commands	Details
<code>getvar</code>	This command retrieves the error code of the last mirroring update (fetch). <i>Format:</i> <code>! U1 getvar "ip.mirror.last_error"</code>



Example • In this example, the `getvar` retrieves the error code of the last mirroring update.

```
! U1 getvar "ip.mirror.last_error"
```



Note •

- For printer support, see [SGD Command Support on page 1267](#).
- For details on SGD command structure, see [Command Structure on page 635](#).

ip.mirror.last_time



Description This command retrieves the timestamp, in seconds, of the last time the system attempted a mirror update (fetch).

Type `getvar`

Commands	Details
<code>getvar</code>	<p>This command retrieves the timestamp, in seconds, of the last time the system attempted a mirror update (fetch).</p> <p><i>Format:</i> <code>! U1 getvar "ip.mirror.last_time"</code></p>



Example • In this example, the `getvar` retrieves the timestamp, in seconds, of the last time the system attempted a mirror update.

```
! U1 getvar "ip.mirror.last_time"
```



Note •

- For printer support, see [SGD Command Support on page 1267](#).
- For details on SGD command structure, see [Command Structure on page 635](#).

ip.mirror.mode



Description This command sets the protocol used to perform mirror tasks.

Type setvar;getvar

Supported Devices

- iMz™ series
- QLn™ series
- ZT200™ series
- ZD500R™ series
-

Commands	Details
setvar	<p>This command sets the protocol for mirror tasks.</p> <p><i>Format:</i> ! U1 setvar "ip.mirror.mode" "values"</p> <p><i>Values:</i></p> <ul style="list-style-type: none">• ftp - FTP protocol will be used to perform mirror tasks• sftp - SFTP protocol will be used to perform mirror tasks <p><i>Default Value:</i> "ftp"</p>
getvar	<p>This command retrieves the path to the application on the mirror server.</p> <p><i>Format:</i> ! U1 getvar "ip.mirror.mode"</p>



Note

- For printer support, see [SGD Command Support on page 1267](#).
- For details on SGD command structure, see [Command Structure on page 635](#).

ip.mirror.password



Description This command specifies the user password on the mirroring server assigned for mirroring updates (fetch).

Type setvar;getvar

Commands	Details
setvar	This command instructs the printer to use a specific password for mirroring updates (fetch). <i>Format:</i> ! U1 setvar "ip.mirror.password" "value" <i>Values:</i> alphanumeric text string (1 to 20 characters) <i>Default Value:</i> "password"
getvar	This command retrieves the user password the printer is currently using for mirroring updates (fetch). <i>Format:</i> ! U1 getvar "ip.mirror.password"



Example • This `setvar` example shows the value set to "password".

```
! U1 setvar "ip.mirror.password" "password"
```

When the `setvar` value is set to "password", the `getvar` result is "*". For security purposes, the printer does not return password information.



Note •

- For printer support, see [SGD Command Support on page 1267](#).
- For details on SGD command structure, see [Command Structure on page 635](#).

ip.mirror.path



Description This command identifies the base path on the FTP server where the mirror directory resides.

Type setvar;getvar

Commands	Details
setvar	This command sets the base path on the FTP server where the mirror directory resides. <i>Format:</i> ! U1 setvar "ip.mirror.path" "value" <i>Values:</i> alphanumeric text string (1 to 50 characters) <i>Default Value:</i> "zebra"
getvar	This command retrieves the base path of the FTP server where the mirror directory resides. <i>Format:</i> ! U1 getvar "ip.mirror.path"



Example • This setvar example shows the value set to "zebra".

```
! U1 setvar "ip.mirror.path" "zebra"
```

When the setvar value is set to "zebra", the getvar result is "zebra".



Note •

- For printer support, see [SGD Command Support on page 1267](#).
- For details on SGD command structure, see [Command Structure on page 635](#).

ip.mirror.reset_delay



Description This command specifies the number of seconds between when the printer receives the last byte of the last file from the /commands directory and when the printer resets during a mirror event.



Note • This command is available in V53.17.5Z, V56.17.4Z, V60.17.5Z, V61.17.4Z and later versions.

Type setvar;getvar

Commands	Details
setvar	<p>This command sets the number of seconds between when the printer receives the last byte of the last file from the /commands directory and when the printer resets during a mirror event.</p> <p><i>Format:</i> ! U1 setvar "ip.mirror.reset_delay" "value"</p> <p><i>Values:</i> 0 - 900 (seconds)</p> <p><i>Default Value:</i> "5"</p> <p> The default setting for the ip.mirror.reset_delay command is 5 seconds; in some cases it may be necessary to use a longer delay to allow for full processing of longer or more complex files.</p>
getvar	<p>This command retrieves the number of seconds between when the printer receives the last byte of the last file from the /commands directory and when the printer resets during a mirror event.</p> <p><i>Format:</i> ! U1 getvar "ip.mirror.reset_delay"</p>



Example • This setvar example shows the value set to "10".

```
! U1 setvar "ip.mirror.reset_delay" "10"
```

When the setvar value is set to "10", the getvar result is "10".



Note •

- For printer support, see [SGD Command Support on page 1267](#).
- For details on SGD command structure, see [Command Structure on page 635](#).

ip.mirror.server



Description This command identifies the IP address of the mirroring server.

Type setvar;getvar

Commands	Details
setvar	This command sets the IP address of the mirroring server. <i>Format:</i> ! U1 setvar "ip.mirror.server" "value" <i>Values:</i> a valid IP address <i>Default Value:</i> "127.0.0.1"
getvar	This command retrieves the IP address of the mirroring server. <i>Format:</i> ! U1 getvar "ip.mirror.server"



Example • This `setvar` example shows the value set to "10.3.1.1".

```
! U1 setvar "ip.mirror.server" "10.3.1.1"
```

When the `setvar` value is set to "10.3.1.1", the `getvar` result is "10.3.1.1".



Note •

- For printer support, see [SGD Command Support on page 1267](#).
- For details on SGD command structure, see [Command Structure on page 635](#).

ip.mirror.success



Description This command reports the success or failure of the last mirroring update (fetch).

Type `getvar`

Commands	Details
<code>getvar</code>	<p>This command retrieves the success or failure of the last mirroring update (fetch).</p> <p><i>Format:</i> <code>! U1 getvar "ip.mirror.success"</code></p> <p><i>Values:</i></p> <ul style="list-style-type: none"> <code>"yes"</code> = successful <code>"no"</code> = unsuccessful



Example • In this example, the `getvar` retrieves the success or failure of the last mirroring update (fetch).

```
! U1 getvar "ip.mirror.success"
```



Note •

- For printer support, see [SGD Command Support on page 1267](#).
- For details on SGD command structure, see [Command Structure on page 635](#).

ip.mirror.success_time



Description This command provides the timestamp, in seconds, of the last time the system successfully completed a mirror update (fetch).

Type `getvar`

Commands	Details
<code>getvar</code>	This command retrieves the timestamp, in seconds, of the last time the system successfully completed a mirror update (fetch). <i>Format: ! U1 getvar "ip.mirror.success_time"</i>



Example • In this example, the `getvar` retrieves the timestamp of the last time the system successfully completed a mirror update.

```
! U1 getvar "ip.mirror.success_time"
```



Note •

- For printer support, see [SGD Command Support on page 1267](#).
- For details on SGD command structure, see [Command Structure on page 635](#).

ip.mirror.username



Description This command specifies the user name on the mirroring server assigned for mirroring updates (fetch).

Type setvar;getvar

Commands	Details
setvar	This command instructs the printer to use a specific user name for mirroring updates (fetch). <i>Format:</i> ! U1 setvar "ip.mirror.username" "value" <i>Values:</i> alphanumeric text string (1 to 20 characters) <i>Default Value:</i> "user"
getvar	This command retrieves the user name the printer is currently using for mirroring updates (fetch). <i>Format:</i> ! U1 getvar "ip.mirror.username"



Example • This `setvar` example shows the value set to "user".

```
! U1 setvar "ip.mirror.username" "user"
```

When the `setvar` value is set to "user", the `getvar` result is "user".



Note •

- For printer support, see [SGD Command Support on page 1267](#).
- For details on SGD command structure, see [Command Structure on page 635](#).

ip.mirror.version



Description This command retrieves the mirror code build date.

Type `getvar`

Commands	Details
<code>getvar</code>	This command retrieves the mirror code build date. <i>Format:</i> <code>! U1 getvar "ip.mirror.version"</code>



Example • In this example, the `getvar` retrieves the mirror code build date.

`! U1 getvar "ip.mirror.version"`



Note •

- For printer support, see [SGD Command Support on page 1267](#).
- For details on SGD command structure, see [Command Structure on page 635](#).

ip.netmask

Description This setting refers to the subnet mask address. This value is ignored if the IP protocol is not set to permanent.

Type setvar;setvar

Commands	Details
setvar	This command instructs the printer to change the subnet mask. <i>Format:</i> ! U1 setvar "ip.netmask" "value" <i>Values:</i> Any valid subnet mask. <i>Default:</i> "255.255.255.0"
getvar	This command instructs the printer to respond with subnet mask. <i>Format:</i> ! U1 getvar "ip.netmask"



Example • This `setvar` example shows the value set to "255.255.255.0".

```
! U1 setvar "ip.netmask" "255.255.255.0"
```

When the `setvar` value is set to "255.255.255.0", the `getvar` result is "255.255.255.0".



Note •

- For printer support, see [SGD Command Support on page 1267](#).
- For details on SGD command structure, see [Command Structure on page 635](#).

ip.pop3.enable

Description This printer setting determines if the printer queries a POP3 mailbox for mail.

Type setvar;setvar

Commands	Details
setvar	This command instructs the printer to turn POP3 on or off. <i>Format:</i> ! U1 setvar "ip.pop3.enable" "value" <i>Values:</i> "off" = disables POP3 "on" = enables POP3 <i>Default:</i> "on"
getvar	This command instructs the printer to respond with the POP3 status. <i>Format:</i> ! U1 getvar "ip.pop3.enable"



Example • This `setvar` example shows the value set to "on".

```
! U1 setvar "ip.pop3.enable" "on"
```

When the `setvar` value is set to "on", the `getvar` result is "on".



Note •

- For printer support, see [SGD Command Support on page 1267](#).
- For details on SGD command structure, see [Command Structure on page 635](#).

ip.pop3.password

Description This printer setting refers to the POP3 mailbox password. This only applies if "ip.pop3.enable" is set to on.

Type setvar;getvar

Commands	Details
setvar	This command instructs the printer to change the POP3 password. <i>Format:</i> ! U1 setvar "ip.pop3.password" "value" <i>Values:</i> A maximum of 20 alphanumeric characters <i>Default:</i> " "
getvar	This command instructs the printer to respond with the POP3 password. <i>Format:</i> ! U1 getvar "ip.pop3.password" For protection a single "*" prints.



Example • This `setvar` example shows the value set to "password".

```
! U1 setvar "ip.pop3.password" "password"
```

When the `setvar` value is set to "password", the `getvar` result is "*".



Note •

- For printer support, see [SGD Command Support on page 1267](#).
- For details on SGD command structure, see [Command Structure on page 635](#).

ip.pop3.poll

Description This printer setting refers to how frequent (in seconds) the printer queries a POP3 mailbox for new mail. This only applies if the "ip.pop3.enable" is set to on.

Type setvar;setvar

Commands	Details
setvar	<p>This command instructs the printer to change the POP3 poll interval. A value of "0" causes the printer to only query the POP3 mailbox one time, on printer power up, or following a network reset.</p> <p><i>Format:</i> ! U1 setvar "ip.pop3.poll" "value"</p> <p><i>Values:</i> "0" through "65535"</p> <p><i>Default:</i> "0"</p> <p> Note • A poll value of less than thirty seconds is not recommended. The printer is unresponsive for several seconds when polling for email depending on data transfer time from the server to the printer.</p>
getvar	<p>This command instructs the printer to respond with the POP3 poll frequency (in seconds).</p> <p><i>Format:</i> ! U1 getvar "ip.pop3.poll"</p>



Example • This setvar example shows the value set to "0".

```
! U1 setvar "ip.pop3.poll" "0"
```

When the setvar value is set to "0", the getvar result is "0".



Note •

- For printer support, see [SGD Command Support on page 1267](#).
- For details on SGD command structure, see [Command Structure on page 635](#).

ip.pop3.server_addr

Description This printer setting refers to the POP3 server IP address that the printer contacts when checking for new mail. This only applies if "ip.pop3.enable" is set to on.

Type setvar;getvar

Commands	Details
setvar	This command instructs the printer to change the POP3 server address. <i>Format:</i> ! U1 setvar "ip.pop3.server_addr" "value" <i>Values:</i> Any valid POP3 server address <i>Default:</i> "0.0.0.0"
getvar	This command instructs the printer to respond with the POP3 server address. <i>Format:</i> ! U1 getvar "ip.pop3.server_addr"



Example • This `setvar` example shows the value set to "10.3.5.10".

```
! U1 setvar "ip.pop3.server_addr" "10.3.5.10"
```

When the `setvar` value is set to "10.3.5.10", the `getvar` result is "10.3.5.10".



Note •

- For printer support, see [SGD Command Support on page 1267](#).
- For details on SGD command structure, see [Command Structure on page 635](#).

ip.pop3.username

Description This printer setting refers to the POP3 user name. This only applies if the "ip.pop3.enable" is set to on.

Type setvar;setvar

Commands	Details
setvar	This command instructs the printer to change the POP3 user name. <i>Format:</i> ! U1 setvar "ip.pop3.username" "value" <i>Values:</i> A maximum of 20 alphanumeric characters <i>Default:</i> " "
getvar	This command instructs the printer to respond with the POP3 user name. <i>Format:</i> ! U1 getvar "ip.pop3.username"



Example • This `setvar` example shows the value set to "user".

```
! U1 setvar "ip.pop3.username" "user"
```

When the `setvar` value is set to "user", the `getvar` result is "user".



Note •

- For printer support, see [SGD Command Support on page 1267](#).
- For details on SGD command structure, see [Command Structure on page 635](#).

ip.port

Description This printer setting refers to the port number that the TCP print service is listening on. Normal TCP communications from the host should be directed to this port.

Type setvar;getvar

Commands	Details
setvar	This command instructs the printer to set the TCP/UDP port number. <i>Format:</i> ! U1 setvar "ip.port" "value" <i>Values:</i> 1 - 65535 (excluding any ports currently used by other services, such as 21, 23, 80, and 515). <i>Default:</i> "9100"
getvar	This command instructs the printer to respond with the TCP/UDP port number. <i>Format:</i> ! U1 getvar "ip.port"



Example • This `setvar` example shows the value set to "9100".

```
! U1 setvar "ip.port" "9100"
```

When the `setvar` value is set to "9100", the `getvar` result is "9100".



Note •

- For printer support, see [SGD Command Support on page 1267](#).
- For details on SGD command structure, see [Command Structure on page 635](#).

ip.port_alternate

Description This command sets the port number of the alternate port.



Note • Print servers supporting this command will monitor both the primary port and the alternate port for connections at the same time.

Supported Devices ZT200 Series

Type setvar;getvar

Commands	Details
setvar	This command sets the alternate port for the print server. <i>Format:</i> ! U1 setvar "ip.port_alternate" "value" <i>Values:</i> Any valid TCP port address. <i>Default:</i> "9100"
getvar	This command returns the current alternate port setting. <i>Format:</i> ! U1 getvar "ip.port_alternate" <i>Values:</i> The current port setting.



Example • This setvar example shows the value set to "6101".

```
U1 setvar "ip.port_alternate" "6101"
```



Note •

- For printer support, see [SGD Command Support on page 1267](#).
- For details on SGD command structure, see [Command Structure on page 635](#).

ip.port_json_config

Description This command determines the TCP port number to listen on for JSON configuration packets.

Supported Devices

- iMZ 220™, iMZ 320™
- QLn220™, QLn320™, QLn420™
- ZT210™, ZT220™, ZT230™

Type setvar, getvar

Commands	Details
setvar	<p>This command sets the TCP port number to listen on for JSON configuration packets.</p> <p><i>Format:</i> ! U1 setvar "ip.port_json_config" "value"</p> <p><i>Values:</i> Any valid port number except ports already in use or the standard network ports.</p> <ul style="list-style-type: none"> • 0 = disable the port • 1-65535 = Port number to listen on. <p><i>Default:</i> "9200"</p>
getvar	<p>This command retrieves the port number.</p> <p><i>Format:</i> ! U1 getvar "ip.port_json_config"</p>



Example • This example sets the port value to listen on as 12444.

```
! U1 setvar "ip.port_json_config" "12444"
```



Note •

- For printer support, see [SGD Command Support on page 1267](#).
- For details on SGD command structure, see [Command Structure on page 635](#).

ip.port_json_config

Description This printer setting refers to the port number that the TCP print service is listening on for JSON configuration packets. JSON TCP communications from the host should be directed to this port.

Supported Devices Link-OS printers with firmware Vxx.19.7Z and later.

Type setvar;setvar

Commands	Details
setvar	This command instructs the printer to set the JSON TCP port number. <i>Format:</i> ! U1 setvar "ip.port_json_config" "value" <i>Values:</i> 0 = Disable the port 1 - 65535 (excluding any ports currently used by other services, such as 21, 23, 80, and 515). <i>Default:</i> "9200"
getvar	This command instructs the printer to respond with the JSON TCP port number. <i>Format:</i> ! U1 getvar "ip.port_json_config"



Example • This `setvar` example shows the value set to "9200".

```
! U1 setvar "ip.port_json_config" "9200"
```

When the `setvar` value is set to "9200", the `getvar` result is "9200".



Note •

- For printer support, see [SGD Command Support on page 1267](#).
- For details on SGD command structure, see [Command Structure on page 635](#).

ip.primary_network

Description This command allows you to set the primary network to either wired or wireless.

Type setvar;getvar

Commands	Details
setvar	<p>This command instructs the printer to set the primary network device.</p> <p><i>Format:</i> ! U1 setvar "ip.primary_network" "value"</p> <p><i>Values:</i></p> <ul style="list-style-type: none"> 1 = wired 2 = wireless <p><i>Default:</i> "1"</p>
getvar	<p>This command instructs the printer to respond with the name of the current primary network device.</p> <p><i>Format:</i> ! U1 getvar "ip.primary_network"</p>



Example • This `setvar` example shows the value set to "1".

```
! U1 setvar "ip.primary_network" "1"
```

What the `setvar` value is set to is the `getvar` result. In this example, the `getvar` result is "1".



Note •

- For printer support, see [SGD Command Support on page 1267](#).
- For details on SGD command structure, see [Command Structure on page 635](#).

ip.smtp.domain

Description This printer setting refers to the domain name used by the printer in sending email with respect to the SMTP server.

Type setvar;setvar

Commands	Details
setvar	This command instructs the printer to change the SMTP domain name. <i>Format:</i> ! U1 setvar "ip.smtp.domain" "value" <i>Values:</i> A maximum of 24 alphanumeric characters <i>Default:</i> "ZBRPrintServer"
getvar	This command instructs the printer to return the SMTP domain name. <i>Format:</i> ! U1 getvar "ip.smtp.domain"



Example • This `setvar` example shows the value set to "ZBRPrintServer.com".

```
! U1 setvar "ip.smtp.domain" "ZBRPrintServer.com"
```

When the `setvar` value is set to "ZBRPrintServer.com", the `getvar` result is "ZBRPrintServer.com".



Note •

- For printer support, see [SGD Command Support on page 1267](#).
- For details on SGD command structure, see [Command Structure on page 635](#).

ip.smtp.enable

Description This printer setting refers to the SMTP protocol.

Type setvar;getvar

Commands	Details
setvar	This command instructs the printer to turn SMTP on or off. <i>Format:</i> ! U1 setvar "ip.smtp.enable" "value" <i>Values:</i> "off" = disables SMTP "on" = enables SMTP <i>Default:</i> "on"
getvar	This command instructs the printer to return the SMTP status. <i>Format:</i> ! U1 getvar "ip.smtp.enable"



Example • This `setvar` example shows the value set to "on".

```
! U1 setvar "ip.smtp.enable" "on"
```

When the `setvar` value is set to "on", the `getvar` result is "on".



Note •

- For printer support, see [SGD Command Support on page 1267](#).
- For details on SGD command structure, see [Command Structure on page 635](#).

ip.smtp.server_addr

Description This printer setting refers to the IP address of the SMTP server used for sending email.

Type setvar;setvar

Commands	Details
setvar	This command instructs the printer to change the SMTP server address. <i>Format:</i> ! U1 setvar "ip.smtp.server_addr" "value" <i>Values:</i> Any valid IP address. <i>Default:</i> 0.0.0.0
getvar	This command instructs the printer to respond with the current SMTP server address. <i>Format:</i> ! U1 getvar "ip.smtp.server_addr"



Example • This `setvar` example shows the value set to `10.10.10.10`.

```
! U1 setvar "ip.smtp.server_addr" "10.10.10.10"
```

When the `setvar` value is set to `"10.10.10.10"`, the `getvar` result is `"10.10.10.10"`.



Note •

- For printer support, see [SGD Command Support on page 1267](#).
- For details on SGD command structure, see [Command Structure on page 635](#).

ip.snmp.get_community_name

Description This printer setting is used when making SNMP queries. The SNMP client must supply the get community name that matches the printer's get community name in order to query any SNMP data.

Type setvar;getvar

Commands	Details
setvar	This command instructs the printer to set the SNMP get community name string. <i>Format:</i> ! U1 setvar "ip.snmp.get_community_name" "value" <i>Values:</i> A maximum of 19 alphanumeric characters. <i>Default:</i> "public"
getvar	This command instructs the printer to get the SNMP get community name string. <i>Format:</i> ! U1 getvar "ip.snmp.get_community_name" For protection a single "*" prints.



Example • This setvar example shows the value set to "public".

```
! U1 setvar "ip.snmp.get_community_name" "public"
```

When the setvar value is set to "public", the getvar result is "*".



Note •

- For printer support, see [SGD Command Support on page 1267](#).
- For details on SGD command structure, see [Command Structure on page 635](#).

ip.snmp.set_community_name

Description This printer setting is used when changing SNMP data remotely. To alter any SNMP data, the SNMP client must supply the set community name that matches the printer's set community name.

Type setvar;getvar

Commands	Details
setvar	This command instructs the printer to set the SNMP set community name string. <i>Format:</i> ! U1 setvar "ip.snmp.set_community_name" "value" <i>Values:</i> A maximum of 19 alphanumeric characters <i>Default:</i> "public"
getvar	This command instructs the printer to return the printer's SNMP set community name string. <i>Format:</i> ! U1 getvar "ip.snmp.set_community_name" For protection a single "*" returns.



Example • This `setvar` example shows the value set to "public".
! U1 setvar "ip.snmp.set_community_name" "public"
When the `setvar` value is set to "public", the `getvar` result is "*".



Note •

- For printer support, see [SGD Command Support on page 1267](#).
- For details on SGD command structure, see [Command Structure on page 635](#).

ip.snmp.trap_community_name

Description This command sets the SNMP Trap Community name of the print server.

Supported Devices ZT200 Series

Type setvar;setvar

Commands	Details
setvar	This command instructs the printer to set the SNMP trap community name. <i>Format:</i> ! U1 setvar "ip.snmp.get_community_name" "value" <i>Values:</i> A maximum of 20 alphanumeric characters. <i>Default:</i> "public"
getvar	This command instructs the printer to get the SNMP trap community name. <i>Format:</i> ! U1 getvar "ip.snmp.trap_community_name"



Example •

```
! U1 setvar "ip.snmp.trap_community_name" "public"
```



Note •

- For printer support, see [SGD Command Support on page 1267](#).
- For details on SGD command structure, see [Command Structure on page 635](#).

ip.snmp.enable

Description This printer setting refers to the SNMP protocol.

Type setvar;setvar

Commands	Details
setvar	This command instructs the printer to enable or disable the SNMP protocol. <i>Format:</i> ! U1 setvar "ip.snmp.enable" "value" <i>Values:</i> "on" = enable the SNMP protocol "off" = disable the SNMP protocol <i>Default:</i> "on"
getvar	This command instructs the printer to respond with the SNMP status. <i>Format:</i> ! U1 getvar "ip.snmp.enable"



Example • This `setvar` example shows the value set to "on".

```
! U1 setvar "ip.snmp.enable" "on"
```

When the `setvar` value is set to "on", the `getvar` result is "on".



Note •

- For printer support, see [SGD Command Support on page 1267](#).
- For details on SGD command structure, see [Command Structure on page 635](#).

ip.telnet.enable

Description This printer setting refers to the TELNET (port 23) protocol.

Type setvar;getvar

Commands	Details
setvar	This command instructs the printer to turn TELNET on or off. <i>Format:</i> ! U1 setvar "ip.telnet.enable" "value" <i>Values:</i> "off" = disables telnet protocol "on" = enables telnet protocol <i>Default:</i> "on"
getvar	This command instructs the printer to respond with the TELNET status. <i>Format:</i> ! U1 getvar "ip.telnet.enable"



Example • This `setvar` example shows the value set to "on".

```
! U1 setvar "ip.telnet.enable" "on"
```

When the `setvar` value is set to "on", the `getvar` result is "on".



Note •

- For printer support, see [SGD Command Support on page 1267](#).
- For details on SGD command structure, see [Command Structure on page 635](#).

ip.tcp.enable

Description This printer setting refers to the TCP socket protocol.

Type setvar;setvar

Commands	Details
setvar	This command instructs the printer to turn the TCP on or off. <i>Format:</i> ! U1 setvar "ip.tcp.enable" "value" <i>Values:</i> "off" = disables TCP protocol "on" = enables TCP protocol <i>Default:</i> "on"
getvar	This command instructs the printer to respond with the TCP status. <i>Format:</i> ! U1 getvar "ip.tcp.enable"



Example • This `setvar` example shows the value set to "on".

```
! U1 setvar "ip.tcp.enable" "on"
```

When the `setvar` value is set to "on", the `getvar` result is "on".



Note •

- For printer support, see [SGD Command Support on page 1267](#).
- For details on SGD command structure, see [Command Structure on page 635](#).

ip.udp.enable

Description This printer setting refers to the UDP socket protocol.

Type setvar;getvar

Commands	Details
setvar	This command instructs the printer to turn UDP on or off. <i>Format:</i> ! U1 setvar "ip.udp.enable" "value" <i>Values:</i> "off" = disables UDP protocol "on" = enables UDP protocol <i>Default:</i> "off"
getvar	This command instructs the printer to respond with the UDP status. <i>Format:</i> ! U1 getvar "ip.udp.enable"



Example • This `setvar` example shows the value set to "on".

```
! U1 setvar "ip.udp.enable" "on"
```

When the `setvar` value is set to "on", the `getvar` result is "on".



Note •

- For printer support, see [SGD Command Support on page 1267](#).
- For details on SGD command structure, see [Command Structure on page 635](#).

weblink.enable

Description This command indicates if one or more of the weblink connections are active.

If there is more than one connection under the weblink branch (for example, `weblink.ip.conn1`) and if any of the `.location` values are set, then this SGD will be set to "on". If all connections are disabled (all connection `.location` values set to ""), then this value will be set to "off".

`^JUF`, `^JUS`, `^JUN`, `^JUA`, and `device.restore_defaults` do not have any affect on this setting.

- iMZ 220™, iMZ 320™
- QLn220™, QLn320™, QLn420™
- ZT210™, ZT220™, ZT230™

Type `getvar`

Commands	Details
<code>getvar</code>	<p>This command indicates if one or more of the weblink connections are active.</p> <p><i>Format:</i> <code>! U1 getvar "weblink.enable"</code></p> <p><i>Result:</i></p> <ul style="list-style-type: none">• "yes" if any of the <code>.location</code> values are set• "off" if all connections are disabled

weblink.ip.conn[1|2].authentication.add

Description This command allows the user to add a single server/username/password triplet into the list of authentication entries.

When the printer attempts to connect to the server (url specified in `weblink.ip.conn[1|2].location`) the server may require HTTP authentication (e.g. digest, basic, DNS, etc.). There may be multiple authentication requests along the route to the destination (e.g. a local server first requires HTTP authentication as well as on the remote server).

For each HTTP authentication request received while attempting to connect, the printer will enumerate the authentication entries and attempt to satisfy the request with the username/password pair provided for the respective server. The server name in the entry is what determines which username/password pair should be used for which authentication request. Both DNS names and IP addresses are acceptable. The server, username, and password are separated by a single space (not a tab or other white space character). The server name is the only required field. If no username is supplied, but a password is, there must be two spaces between the server and the password fields. If there is a username but no password, or simply just the servername, no space is required at the end of the entry.

If the command is changed when the connection is enabled (`weblink.enable` is set to "on"), it will not take effect until the connection is disabled and then re-enabled.



Important • This setting only be changed when `weblink.enable` is set to "off".

`^JUF`, `^JUS`, `^JUN`, `^JUA`, and `device.restore_defaults` do not have any affect on this setting.

Supported Devices

- iMZ 220™, iMZ 320™
- QLn220™, QLn320™, QLn420™
- ZT210™, ZT220™, ZT230™

Type `setvar`

Commands	Details
setvar	<p>This command adds a single server/username/password triplet to the list of authentication entries.</p> <p><i>Format:</i></p> <ul style="list-style-type: none"> • ! U1 setvar "weblink.ip.conn1.authentication.add" "servername[username][password]" • ! U1 setvar "weblink.ip.conn2.authentication.add" "servername[username][password]" <p><i>Values:</i> servername [username][password] has a maximum length of string is 2048 characters</p> <p><i>Default:</i> NA</p>



Example 1 • In this example, a username and a password is supplied:

```
! U1 setvar "weblink.ip.conn1.authentication.add" "my.server.lan johndoe
password"
```

Example 2 • In this example, no password is supplied

```
! U1 setvar "weblink.ip.conn1.authentication.add" "my.server.lan johndoe"
```

Example 3 • In this example, no username is supplied (note the double space)

```
! U1 setvar "weblink.ip.conn1.authentication.add" "my.server.lan password"
```

Example 4 • In this example, no username or password is supplied

```
! U1 setvar "weblink.ip.conn1.authentication.add" "my.server.lan"
```

weblink.ip.conn[1|2].authentication.entries

Description This command lists the server names added to the authentication entries list.

Only the server names will be shown. The username and passwords will not be shown. The server names are separated by a `\r\n` so that each shows up on its own line.

`^JUF`, `^JUS`, `^JUN`, `^JUA`, and `device.restore_defaults` do not have any affect on this setting.

Supported Devices

- iMZ 220™, iMZ 320™
- QLn220™, QLn320™, QLn420™
- ZT210™, ZT220™, ZT230™

Type `getvar`

Commands	Details
<code>getvar</code>	<p>This command lists the server names for the specified connection.</p> <p><i>Format:</i></p> <ul style="list-style-type: none"> • ! U1 <code>getvar "weblink.ip.conn1.authentication.entries"</code> • ! U1 <code>getvar "weblink.ip.conn2.authentication.entries"</code>

weblink.ip.conn[1|2].authentication.remove

Description This command allows the user to remove a single server/username/password triplet from the list of authentication entries.

To remove an entry only the server name is supplied. If an invalid entry is supplied no action is taken. If the SGD is changed when the connection is enabled (`weblink.ip.conn[1|2].enable`), it will not take effect until the connection is disabled and then re-enabled. It is therefore recommended that this setting only be changed when `weblink.ip.conn[1|2].enable` is set to "off".

`^JUF`, `^JUS`, `^JUN`, `^JUA`, and `device.restore_defaults` do not have any affect on this setting.

Supported Devices

- iMZ 220™, iMZ 320™
- QLn220™, QLn320™, QLn420™
- ZT210™, ZT220™, ZT230™

Type `setvar`

Commands	Details
<code>setvar</code>	<p>This command removes a single server/username/password triplet from the list of authentication entries.</p> <p><i>Format:</i></p> <ul style="list-style-type: none"> • <code>! U1 setvar "weblink.ip.conn1.authentication.remove" "servername"</code> • <code>! U1 setvar "weblink.ip.conn2.authentication.remove" "servername"</code> <p><i>Values:</i> servername has a maximum length of string is 2048 characters.</p> <p><i>Default:</i> NA</p>



Example • In this example, a username and a password is supplied

```
! U1 setvar "weblink.ip.conn1.authentication.remove" "my.server.lan"
```

weblink.ip.conn[1|2].location

Description This command assigns the URL of the server for this connection. The URL must follow the URL rules for the HTTP[S] protocol outlined in RFC2396 (<http://www.ietf.org/rfc/rfc2396.txt>).

The setting will not take effect until the printer is reset. Changing this setting will set `weblink.printer_reset_required` to "yes".

`^JUF`, `^JUS`, `^JUN`, `^JUA`, and `device.restore_defaults` do not have any affect on this setting.

Supported Devices

- iMz™ series
- QLn™ series
- ZT200™ series
- ZD500R™ series

Type `setvar`, `getvar`

Commands	Details
<code>setvar</code>	<p>This command sets the server URL for the specified connection.</p> <p><i>Format:</i></p> <ul style="list-style-type: none"> • <code>! U1 setvar "weblink.ip.conn1.location" "value"</code> • <code>! U1 setvar "weblink.ip.conn2.location" "value"</code> <p><i>Values:</i> any HTTPS URL up to 2048 characters</p> <p><i>Default:</i> ""</p>
<code>getvar</code>	<p>This command returns the server URL currently assigned to the connection.</p> <p><i>Format:</i></p> <ul style="list-style-type: none"> • <code>! U1 getvar "weblink.ip.conn1.location"</code> • <code>! U1 getvar "weblink.ip.conn2.location"</code>



Example •

```
! U1 setvar "weblink.ip.conn2.location"
"https://my.linkos.server.com:8080/link/os"
```

weblink.ip.conn[1|2].maximum_simultaneous_connections

Description This command indicates the maximum number of simultaneous connections that can be initiated by the printer.

Via the main connection (the original connection initiated by the printer to the remote server), the remote server can request that additional connections from the printer be initiated (e.g. a connection that supports only JSON SGDs, one that behaves similar to the RAW TCP port).

The server is free to request as many as it thinks it needs, but the printer will prevent more than N number of connections, where N is the value of this command.

`^JUF`, `^JUS`, `^JUN`, `^JUA`, and `device.restore_defaults` do not have any affect on this setting.

Supported Devices

- iMZ 220™, iMZ 320™
- QLn220™, QLn320™, QLn420™
- ZT210™, ZT220™, ZT230™

Type setvar, getvar

Commands	Details
setvar	<p>This command sets the maximum number of connections.</p> <p><i>Format:</i></p> <ul style="list-style-type: none"> • ! U1 setvar "weblink.ip.conn1.maximum_simultaneous_connections" "value" • ! U1 setvar "weblink.ip.conn2.maximum_simultaneous_connections" "value" <p><i>Values:</i> Any integer from 1-100</p> <p><i>Default:</i> "10"</p>
getvar	<p>This command retrieves the maximum set number of connections.</p> <p><i>Format:</i></p> <ul style="list-style-type: none"> • ! U1 getvar "weblink.ip.conn1.maximum_simultaneous_connections" • ! U1 getvar "weblink.ip.conn2.maximum_simultaneous_connections"



Example • This example sets the conn1 maximum connections to 3.

```
! U1 setvar "weblink.ip.conn1.maximum_simultaneous_connections" "3"
```

weblink.ip.conn[1|2].num_connections

Description This command reports the number of established connections on conn1 and conn2. Once the connection is established, this number will be incremented. When a channel is closed or the connection times out, the number is decremented..

Supported Devices

- iMz™ series
- QLn™ series
- ZT200™ series
- ZD500R™ series

Type `getvar`

Commands	Details
<code>getvar</code>	<p>This command retrieves the number of active connections on conn1 and conn2.</p> <p><i>Format:</i></p> <ul style="list-style-type: none"> • <code>! U1 getvar "weblink.ip.conn1.num_connections"</code> • <code>! U1 getvar "weblink.ip.conn2.num_connections"</code>



Note •

- For printer support, see [SGD Command Support on page 1267](#).
- For details on SGD command structure, see [Command Structure on page 635](#).

weblink.ip.conn[1|2].proxy

Description This command assigns the URL of the proxy for the connection.

The proxy server protocol, port, domain, username, and password are all encoded into the URL via the format outlined in RFC2396 (<http://www.ietf.org/rfc/rfc2396.txt>).

The username and password must avoid the invalid characters listed in RFC2396 (e.g. '!', '@', '/', etc). If an invalid character must be used it needs to be escaped using '%' as described in RFC2396.

^JUF, ^JUS, ^JUN, ^JUA, and `device.restore_defaults` do not have any affect on this setting.

Supported Devices

- iMZ 220™, iMZ 320™
- QLn220™, QLn320™, QLn420™
- ZT210™, ZT220™, ZT230™

Type `setvar`, `getvar`, `do`

Commands	Details
<code>setvar</code>	<p>This command assigns the URL of the connection proxy.</p> <p><i>Format:</i></p> <ul style="list-style-type: none"> • ! U1 <code>setvar "weblink.ip.conn1.proxy" "url"</code> • ! U1 <code>setvar "weblink.ip.conn2.proxy" "url"</code> <p><i>Values:</i></p> <ul style="list-style-type: none"> • Any valid URL up to 2048 characters • Expected URL format: [http https]://[user:pass@]domain[:port]/[path] • The URL will need to be built according to the server/proxy environment the printer is running within. <p><i>Default:</i> ""</p> <ul style="list-style-type: none"> • The user:pass, port, and path are all optional. • The default scheme must be either HTTPS or HTTP. The default is HTTP. • The default port is 1080. • The default is to omit the username and password.
<code>getvar</code>	<p>This command retrieves the URL of the connection proxy.</p> <p><i>Format:</i></p> <ul style="list-style-type: none"> • ! U1 <code>getvar "weblink.ip.conn1.proxy"</code> • ! U1 <code>getvar "weblink.ip.conn2.proxy"</code>

Commands	Details
do	<p>This command assigns the URL of the connection proxy.</p> <p><i>Format:</i></p> <ul style="list-style-type: none"> • ! U1 do "weblink.ip.conn1.proxy" "url" • ! U1 do "weblink.ip.conn2.proxy" "url" <p><i>Values:</i></p> <ul style="list-style-type: none"> • Any valid URL up to 2048 characters • Expected URL format: [scheme://][user:pass@]domain[:port]/[path] • The URL will need to be built according to the server/proxy environment the printer is running within. <p><i>Default:</i> ""</p> <ul style="list-style-type: none"> • The scheme, user:pass, port, and path are all optional. • The default scheme is http. • The default port is 1080. • The default is to omit the username and password.



Example • Examples of how to connect to various proxy servers:

```
http://username:password@mydomain.com:3128/
http://mydomain.com/
```

weblink.ip.conn[1|2].retry_interval

Description This command sets the number of seconds between attempts to connect to the server URL provided in `weblink.ip.conn1.location`. If an attempt is unsuccessful or the connection is lost, the printer will wait '`retry_interval`' seconds before attempting to connect again.

`^JUF`, `^JUS`, `^JUN`, `^JUA`, and `device.restore_defaults` do not have any affect on this setting.

Supported Devices

- iMZ 220™, iMZ 320™
- QLn220™, QLn320™, QLn420™
- ZT210™, ZT220™, ZT230™

Type setvar, getvar, do

Commands	Details
setvar	<p>This command sets the number of seconds to wait before attempting to reconnect to the server.</p> <p><i>Format:</i></p> <ul style="list-style-type: none"> • ! U1 setvar "weblink.ip.conn1.retry_interval" "value" • ! U1 setvar "weblink.ip.conn2.retry_interval" "value" <p><i>Values:</i> 1 - 600</p> <p><i>Default:</i> "10"</p>
getvar	<p>This command returns the number of seconds to wait between connection attempts.</p> <p><i>Format:</i></p> <ul style="list-style-type: none"> • ! U1 getvar "weblink.ip.conn1.retry_interval" • ! U1 getvar "weblink.ip.conn2.retry_interval"
do	<p>This command sets the number of seconds to wait before attempting to reconnect to the server.</p> <p><i>Format:</i></p> <ul style="list-style-type: none"> • ! U1 do "weblink.ip.conn1.retry_interval" "value" • ! U1 do "weblink.ip.conn2.retry_interval" "value" <p><i>Values:</i> 1 - 600</p> <p><i>Default:</i> "10"</p>

weblink.ip.conn[1|2].test.location

Description This command holds the URL for testing a connection to the internet. This is meant to assist users in debugging their printer's connection to remote servers when there are issues with the main weblink connection (conn1 or conn2).

The URL must follow the URL rules for the HTTP[S] protocol outlined in RFC2396 (<http://www.ietf.org/rfc/rfc2396.txt>).

^JUF, ^JUS, ^JUN, ^JUA, and `device.restore_defaults` do not have any affect on this setting.

Supported Devices

- iMZ 220™, iMZ 320™
- QLn220™, QLn320™, QLn420™
- ZT210™, ZT220™, ZT230™

Type setvar, getvar, do

Commands	Details
setvar	<p>This command sets the URL to hold for testing a connection.</p> <p><i>Format:</i></p> <ul style="list-style-type: none"> • ! U1 setvar "weblink.ip.conn1.test.location" "url" • ! U1 setvar "weblink.ip.conn2.test.location" "url" <p><i>Values:</i> Any HTTPS URL up to 2048 characters</p> <p><i>Default:</i> "http://www.zebra.com/apps/linktest"</p>
getvar	<p>This command retrieves the printer's test connection URL.</p> <p><i>Format:</i></p> <ul style="list-style-type: none"> • ! U1 getvar "weblink.ip.conn1.test.location" • ! U1 getvar "weblink.ip.conn2.test.location"
do	<p>This command sets the URL to hold for testing a connection.</p> <p><i>Format:</i></p> <ul style="list-style-type: none"> • ! U1 do "weblink.ip.conn1.test.location" "url" • ! U1 do "weblink.ip.conn2.test.location" "url" <p><i>Values:</i> Any HTTPS URL up to 2048 characters</p> <p><i>Default:</i> "http://www.zebra.com/apps/linktest"</p>



Example • The test connection can assist the user in several ways/scenarios:

1. If the `test.test_on` value is set to `"failure"`, any time the main weblink (`conn[1|2].location`) connection fails to connect then the `test.location` URL will be used. In this situation, an attempt will be made to contact the remote URL in `test.location`, using authentication and proxy configuration that is specified by the main connection.
2. If the `test.test_on` value is set to `"interval"` an attempt will be made to contact the remote URL in `test.location` every `test.retry_interval` seconds, using authentication and proxy configuration that is specified by the main connection.
3. If the `test.test_on` value is set to `"both"`, then scenario 1 and 2 will both occur. This is useful for users who will use an HTTP connection to move through their firewall - and thereafter frequently refresh the connection to indicate to their firewall that there is still activity for the purpose of keeping the connection alive.

weblink.ip.conn[1|2].test.retry_interval

Description This command determines how often, in seconds, a connection to the test.location URL should be attempted. This setting is only applicable when the test.test_on SGD is set to "interval" or "both".

^JUF, ^JUS, ^JUN, ^JUA, and device.restore_defaults do not have any affect on this setting.

Supported Devices

- iMZ 220™, iMZ 320™
- QLn220™, QLn320™, QLn420™
- ZT210™, ZT220™, ZT230™

Type setevvar, getvar, do

Commands	Details
setvar	<p>This command sets the interval for how often a connection to the test.location URL should be attempted.</p> <p><i>Format:</i></p> <ul style="list-style-type: none"> • ! U1 setvar "weblink.ip.conn1.test.retry_interval" "value" • ! U1 setvar "weblink.ip.conn2.test.retry_interval" "value" <p><i>Values:</i> 0-1800 (in seconds, providing 0 second - 30 minute interval)</p> <p><i>Default:</i> "900"</p>
getvar	<p>This command retrieves the retry interval.</p> <p><i>Format:</i></p> <ul style="list-style-type: none"> • ! U1 getvar "weblink.ip.conn1.test.retry_interval" • ! U1 getvar "weblink.ip.conn2.test.retry_interval"
do	<p>This command sets the interval for how often a connection to the test.location URL should be attempted.</p> <p><i>Format:</i></p> <ul style="list-style-type: none"> • ! U1 do "weblink.ip.conn1.test.retry_interval" "value" • ! U1 do "weblink.ip.conn2.test.retry_interval" "value" <p><i>Values:</i> 0-1800</p> <p><i>Default:</i> "900"</p>

weblink.ip.conn[1|2].test.test_on

Description This command determines when the test connection should be attempted. This assists in debugging the printer's connection to remote servers when there are issues with the main weblink connection (conn1 or conn2).

`^JUF`, `^JUS`, `^JUN`, `^JUA`, and `device.restore_defaults` do not have any affect on this setting.

Supported Devices

- iMZ 220™, iMZ 320™
- QLn220™, QLn320™, QLn420™
- ZT210™, ZT220™, ZT230™

Type setvar, getvar, do

Commands	Details
setvar	<p>This command indicate when the test connection should be attempted.</p> <p><i>Format:</i></p> <ul style="list-style-type: none"> • ! U1 setvar "weblink.ip.conn1.test.test_on" "value" • ! U1 setvar "weblink.ip.conn2.test.test_on" "value" <p><i>Values:</i> off, failure, interval, both</p> <p><i>Default:</i> "failure"</p>
getvar	<p>This command retrieves the test connection setting.</p> <p><i>Format:</i></p> <ul style="list-style-type: none"> • ! U1 getvar "weblink.ip.conn1.test.test_on" • ! U1 getvar "weblink.ip.conn2.test.test_on"
do	<p>This command sets when the test connection should be attempted.</p> <p><i>Format:</i></p> <ul style="list-style-type: none"> • ! U1 do "weblink.ip.conn1.test.test_on" "value" • ! U1 do "weblink.ip.conn2.test.test_on" "value" <p><i>Values:</i> off, failure, interval, both</p> <p><i>Default:</i> "failure"</p>



Example • The test connection can assist the user in several ways/scenarios:

1. If the `test.test_on` value is set to `"failure"`, any time the main weblink (`conn[1|2].location`) connection fails to connect then the `test.location` URL will be used. An attempt will be made to contact the remote URL in `test.location`, using authentication and proxy configuration that is specified by the main connection.
2. If the `test.test_on` value is set to `"interval"` an attempt will be made to contact the remote URL in `test.location` every `test.retry_interval` seconds, using authentication and proxy configuration that is specified by the main connection.
3. If the `test.test_on` value is set to `"both"`, then scenario 1 and 2 will both occur. This is useful for users who will use an HTTP connection to move through their firewall - and thereafter frequently refresh the connection to indicate to their firewall that there is still activity for the purpose of keeping the connection alive.

weblink.logging.clear

Description This command clears the weblink log. Setting this value to anything will clear it, including an empty string.

`^JUF`, `^JUS`, `^JUN`, `^JUA`, and `device.restore_defaults` do not have any affect on this setting.

Supported Devices

- iMZ 220™, iMZ 320™
- QLn220™, QLn320™, QLn420™
- ZT210™, ZT220™, ZT230™

Type setvar, do

Commands	Details
setvar	This command clears the weblink log entires. <i>Format:</i> <code>! U1 setvar "weblink.logging.clear" "value"</code> <i>Values:</i> Any string value, including an empty string. <i>Default:</i> NA
do	This command clears the weblink log entires. <i>Format:</i> <code>! U1 do "weblink.logging.clear" "value"</code> <i>Values:</i> Any string value, including an empty string. <i>Default:</i> NA



Example • This example clears the weblink log entries with an empty string value.

```
! U1 setvar "weblink.logging.clear" ""
```

weblink.logging.entries

Description This command returns the N number of entries in the weblink log, where N has a maximum value that is set by `weblink.logging.max_entries`.

The weblink log is a collection of events related to connecting to a remote Link-OS™ server. The log entries range anywhere from general status to errors that prevented a successful connection. The log contains entries from all connections and are labeled so that it is clear which log entries are for which connection. Each log entry also contains a timestamp for when it was logged by the system. The newest events will appear at the bottom of the list.

`^JUF`, `^JUS`, `^JUN`, `^JUA`, and `device.restore_defaults` do not have any affect on this setting.

Supported Devices

- iMZ 220™, iMZ 320™
- QLn220™, QLn320™, QLn420™
- ZT210™, ZT220™, ZT230™

Type `getvar`

Commands	Details
<code>getvar</code>	<p>This command returns a lists of entries in the weblink log.</p> <p><i>Format:</i> ! U1 <code>getvar "weblink.logging.entries"</code></p> <p><i>Values:</i> NA</p> <p><i>Default:</i> ""</p>



Example • This example shows the result from `weblink.logging.entries`:

```
[01-04-2013 08:40:45.655] [conn1.1] HTTP/1.1 404 Not Found
[01-04-2013 08:40:45.659] [conn1.1] Received HTTP code 404 from proxy
after CONNECT
[01-04-2013 08:40:45.660] [conn1.1] Closing connection
[01-04-2013 08:40:45.662] [conn1.1] Failed to connect (SP = 0, CU = 0, UW
= 0, AC = 0, PC = 0)
```

weblink.logging.max_entries

Description This command specifies the maximum number of individual log entries that will be stored in the `weblink.logging.entries` command.



Important • Changes to this command are immediate and may result in some log entries being lost. If there are N log entries currently in the log, the user sets the max_entries to M, where M is less than N, the oldest (N-M) log entries will be removed.

`^JUF`, `^JUS`, `^JUN`, `^JUA`, and `device.restore_defaults` do not have any affect on this setting.

Supported Devices

- iMZ 220™, iMZ 320™
- QLn220™, QLn320™, QLn420™
- ZT210™, ZT220™, ZT230™

Type `setvar`, `getvar`, `do`

Commands	Details
<code>setvar</code>	This command sets the maximum number of log entries that will be stored. <i>Format:</i> ! U1 setvar "weblink.logging.max_entries" "value" <i>Values:</i> 0 - 10000 Note • Setting the value to 0 disables logging. <i>Default:</i> "0"
<code>getvar</code>	This command returns the setting for the maximum number of log entries that will be stored. <i>Format:</i> ! U1 getvar "weblink.logging.max_entries"
<code>do</code>	This command sets the maximum number of log entries that will be stored. <i>Format:</i> ! U1 do "weblink.logging.max_entries" "value" <i>Values:</i> 0 - 10000 Note • Setting the value to 0 disables logging. <i>Default:</i> "0"



Example 1 • In this example, `weblink.logging.max_entries` is set to 3:

```
[01-04-2013 08:40:45.659] [conn1.1] Received HTTP code 404 from proxy  
after CONNECT
```

```
[01-04-2013 08:40:45.660] [conn1.1] Closing connection
```

```
[01-04-2013 08:40:45.662] [conn1.1] Failed to connect (SP = 0, CU = 0, UW  
= 0, AC = 0, PC = 0)
```

Example 2 • In this example, `weblink.logging.max_entries` is set to 2:

`weblink.logging.entries` becomes:

```
[01-04-2013 08:40:45.660] [conn1.1] Closing connection
```

```
[01-04-2013 08:40:45.662] [conn1.1] Failed to connect (SP = 0, CU = 0, UW  
= 0, AC = 0, PC = 0)
```

weblink.printer_reset_required

Description This command retrieves a "yes" or "no" value indicating whether any of the weblink settings have been modified.

^JUF, ^JUS, ^JUN, ^JUA, and `device.restore_defaults` do not have any effect on this setting.

Supported Devices

- iMZ 220™, iMZ 320™
- QLn220™, QLn320™, QLn420™
- ZT210™, ZT220™, ZT230™

Type `getvar`

Commands	Details
<code>getvar</code>	<p>This command retrieves whether any of the weblink settings are modified.</p> <p><i>Format:</i> ! U1 <code>getvar "weblink.printer_reset_required"</code></p> <p><i>Values:</i> "yes" or "no"</p> <p><i>Default:</i> "no"</p>

weblink.restore_defaults

Description This command defaults, and saves, the weblink branch settings. Any value, including an empty string, will default the weblink branch settings.



Note • The entire weblink branch of settings will be defaulted and the settings are saved; however, the weblink connections will not use the new settings until the printer is restarted (e.g. the `weblink.printer_reset_required` SGD will be "yes" after a default).

`^JUF`, `^JUS`, `^JUN`, `^JUA`, and `device.restore_defaults` do not have any affect on this setting.

Supported Devices

- iMZ 220™, iMZ 320™
- QLn220™, QLn320™, QLn420™
- ZT210™, ZT220™, ZT230™

Type `setvar`, `do`

Commands	Details
<code>setvar</code>	This command defaults the weblink branch settings. <i>Format:</i> ! U1 setvar "weblink.restore_defaults" "value" <i>Values:</i> Any value, including an empty string, will default the branch <i>Default:</i> NA
<code>do</code>	This command defaults the weblink branch settings. <i>Format:</i> ! U1 do "weblink.restore_defaults" "value" <i>Values:</i> Any value, including an empty string, will default the branch <i>Default:</i> NA



Example • These all default the branch:

```
! U1 setvar "weblink.restore_defaults" ""
! U1 setvar "weblink.restore_defaults" "foo"
! U1 do "weblink.restore_defaults" ""
! U1 do "weblink.restore_defaults" "foo"
```

wlan.11n.20mhz_only

Description This command forces 20 MHz operation only in printers with 802.11n radios.

Supported Devices ZT200 Series

Type setvar;setvar

Commands	Details
setvar	This command forces 20 MHz operation only in printers with 802.11n radios. <i>Format:</i> ! U1 setvar "wlan.11n.20mhz_only" "value" <i>Values:</i> "on" "off" <i>Default:</i> "off"
getvar	This command returns the current setting for 20 MHz operation only. <i>Format:</i> ! U1 getvar "wlan.11n.20mhz_only"



Example •

```
U1 setvar "wlan.11n.20mhz_only" "on"
```



Note •

- For printer support, see [SGD Command Support on page 1267](#).
- For details on SGD command structure, see [Command Structure on page 635](#).

wlan.11n.aggregation

Description This command enable or disables Aggregation MAC Service Data Unit (A-MSDU) in 802.11n radio communications.

Supported Devices ZT200 Series

Type setvar;setvar

Commands	Details
setvar	This command enables or disables A-MSDU in 802.11n radio communications. <i>Format:</i> ! U1 setvar "wlan.11n.aggregation" "value" <i>Values:</i> "on" "off" <i>Default:</i> "off"
getvar	This command returns the current setting for A-MSDU. <i>Format:</i> ! U1 getvar "wlan.11n.aggregation"



Example •

```
U1 setvar "wlan.11n.aggregation" "on"
```



Note •

- For printer support, see [SGD Command Support on page 1267](#).
- For details on SGD command structure, see [Command Structure on page 635](#).

wlan.11n.greenfield

Description This command will enable or disable greenfield mode in 802.11n radio communications.

Supported Devices ZT200 Series

Type setvar;setvar

Commands	Details
setvar	This command enables/disables greenfield mode. <i>Format:</i> ! U1 setvar "wlan.11n.greenfield" "value" <i>Values:</i> "on" "off" <i>Default:</i> "off"
getvar	This command returns the current setting for greenfield mode. <i>Format:</i> ! U1 getvar "wlan.11n.greenfield"



Example •

```
U1 setvar "wlan.11n.greenfield" "on"
```



Note •

- For printer support, see [SGD Command Support](#) on page 1267.
- For details on SGD command structure, see [Command Structure](#) on page 635.

wlan.11n.rifs

Description This command enable/disables Reduced Interframe Space (RIFS) in 802.11n radio communications.

Supported Devices ZT200 Series

Type setvar;setvar

Commands	Details
setvar	This command enable/disables RIFS in 802.11n. <i>Format:</i> ! U1 setvar "wlan.11n.rifs" "value" <i>Values:</i> "on" "off" <i>Default:</i> "off"
getvar	This command returns the current setting for RIFS. <i>Format:</i> ! U1 getvar "wlan.11n.rifs"



Example •

```
U1 setvar "wlan.11n.rifs" "on"
```



Note •

- For printer support, see [SGD Command Support](#) on page 1267.
- For details on SGD command structure, see [Command Structure](#) on page 635.

wlan.11n.short_gi_40mhz

Description This command enables/disables short Guard Interval in 40 mhz mode.

Supported Devices ZT200 Series

Type setvar;setvar

Commands	Details
setvar	This command enables/disables short Guard Interval in 40 mhz mode. <i>Format:</i> ! U1 setvar "wlan.11n.short_gi_40mhz" "value" <i>Values:</i> "on" "off" <i>Default:</i> "off"
getvar	This command returns the current setting for short Guard Interval 40mhz operation. <i>Format:</i> ! U1 getvar "wlan.11n.short_gi_40mhz"



Example •

```
U1 setvar "wlan.11n.short_gi_40mhz" "on"
```



Note •

- For printer support, see [SGD Command Support](#) on page 1267.
- For details on SGD command structure, see [Command Structure](#) on page 635.

wlan.11n.short_gi_20mhz

Description This command enables/disables short Guard Interval (GI) in 20 mhz mode.

Supported Devices ZT200 Series

Type setvar;setvar

Commands	Details
setvar	This command enables/disables short Guard Interval in 20 mhz mode. <i>Format:</i> ! U1 setvar "wlan.11n.short_gi_20mhz" "value" <i>Values:</i> "on" "off" <i>Default:</i> "off"
getvar	This command returns the current setting for short Guard Interval 20mhz operation. <i>Format:</i> ! U1 getvar "wlan.11n.short_gi_20mhz"



Example •

```
U1 setvar "wlan.11n.short_gi_20mhz" "on"
```



Note •

- For printer support, see [SGD Command Support](#) on page 1267.
- For details on SGD command structure, see [Command Structure](#) on page 635.

wlan.8021x.validate_peap_server_certificate

Description This command determines if the printer will validate the PEAP server certificate.

Type setvar;getvar

Commands	Details
setvar	Description <i>Format:</i> ! U1 setvar "wlan.8021x.validate_peap_server_certificate" "value" <i>Values:</i> "on" "off" <i>Default:</i> "on"
getvar	This command returns the current setting. <i>Format:</i> ! U1 getvar "wlan.8021x.validate_peap_server_certificate"



Example •

```
! U1 setvar "wlan.8021x.validate_peap_server_certificate"
```



Important • When using certificate files, the time on the printer must be set correctly for the websocket connection to succeed, as the time is used in the certificate validation.



Note •

- For printer support, see [SGD Command Support on page 1267](#).
- For details on SGD command structure, see [Command Structure on page 635](#).

wlan.active_channels

Description This command returns list of current active channels defined by [wlan.allowed_band](#) on page 1100 and [wlan.user_channel_list](#) on page 1180.

Supported Devices ZT200 Series

Type getvar

Commands	Details
getvar	<p>This command returns the list of current active channels.</p> <p><i>Format:</i> ! U1 getvar "wlan.active_channels"</p> <p><i>Result:</i> One or more of the following channels: 1, 2, 3, 4, 5, 6, 7, 8, 9, 10, 11, 36, 40, 44, 48, 52, 56, 60, 64, 100, 104, 108, 112, 116, 132, 136, 140, 149, 153, 157, 161, 165, all</p>



Note •

- For printer support, see [SGD Command Support](#) on page 1267.
- For details on SGD command structure, see [Command Structure](#) on page 635.

wlan.allowed_band

Description This command provides a method to restrict the 802.11n radio to either the 2.4 GHz or 5 GHz band.

Use this option when it is beneficial to have the radio use only one frequency band. Setting the 802.11n radio to one band will reduce roaming and radio association times since the radio will not scan as many channels.

Related Commands:

- [wlan.active_channels](#) on page 1099
- [wlan.user_channel_list](#) on page 1180

Supported Devices ZT200 Series

Type setvar;getvar

Commands	Details
setvar	<p>This command restricts the 802.11n radio to either the 2.4 GHz or 5 GHz band.</p> <p><i>Format:</i> ! U1 setvar "wlan.allowed_band" "value"</p> <p><i>Values:</i> "2.4, 5, all"</p> <p><i>Default:</i> "all"</p> <p>Note • If both bands are desired, use "all"</p>
getvar	<p>This command returns the current setting for allowed bands.</p> <p><i>Format:</i> ! U1 getvar "wlan.allowed_band"</p>



Example • This example sets the allowed band to only the 2.4 GHz band.

```
U1 setvar "wlan.allowed_band" "2.4"
```



Note •

- For printer support, see [SGD Command Support](#) on page 1267.
- For details on SGD command structure, see [Command Structure](#) on page 635.

wlan.adhocautomode

Description This printer setting refers to enabling or disabling the adhoc auto mode.

Type setvar;getvar

Commands	Details
setvar	This command instructs the printer to set the adhoc auto mode. <i>Format:</i> ! U1 setvar "wlan.adhocautomode" "value" <i>Values:</i> "on" = adhoc auto mode enabled "off" = adhoc auto mode disabled <i>Default:</i> "off"
getvar	This command instructs the printer to respond with the adhoc auto mode status. <i>Format:</i> ! U1 getvar "wlan.adhocautomode"



Example • This `setvar` example shows the value set to "on".

```
! U1 setvar "wlan.adhocautomode" "on"
```

When the `setvar` value is set to "on", the `getvar` result is "on".



Note •

- For printer support, see [SGD Command Support on page 1267](#).
- For details on SGD command structure, see [Command Structure on page 635](#).

wlan.adhocchannel

Description This printer setting refers to specifying the wireless channel for adhoc channel.

Type setvar;getvar

Commands	Details
setvar	This command instructs the printer to set the wireless channel for adhoc channel mode. <i>Format:</i> ! U1 setvar "wlan.adhocchannel" "value" <i>Values:</i> Decimal value between 1 and 16 inclusive <i>Default:</i> "1"
getvar	This command instructs the printer to respond with the wireless channel for adhoc channel mode. <i>Format:</i> ! U1 getvar "wlan.adhocchannel"



Example • This `setvar` example shows the value set to "1".

```
! U1 setvar "wlan.adhocchannel" "1"
```

When the `setvar` value is set to "1", the `getvar` result is "1".



Note •

- For printer support, see [SGD Command Support on page 1267](#).
- For details on SGD command structure, see [Command Structure on page 635](#).

wlan.associated

Description This command refers to if the printer is or is not associated with an access point (AP).

Type `getvar`

Commands	Details
<code>getvar</code>	This command instructs the printer to respond with yes or no, which identifies if it is associated with the AP. <i>Format: ! U1 getvar "wlan.associated"</i>



Example • In this example, the `getvar` result is "yes".

```
! U1 getvar "wlan.associated"
```



Note •

- For printer support, see [SGD Command Support on page 1267](#).
- For details on SGD command structure, see [Command Structure on page 635](#).

wlan.auth_type

Description This parameter selects the authentication service to be used between the printer and the Access Point. Open System and Shared Key are the two types of authentication services.

Type setvar;getvar

Commands	Details
setvar	This command instructs the printer to set the authentication type to the specified value. <i>Format:</i> ! U1 setvar "wlan.auth_type" "value" <i>Values:</i> "open" "shared" <i>Default:</i> "open"
getvar	This command instructs the printer to retrieve the current authentication type. <i>Format:</i> ! U1 getvar "wlan.auth_type"



Example 1 • This example instructs the printer to set the authentication type to Shared Key.

```
! U1 setvar "wlan.auth_type" "shared"
```

The authentication type will be set to Shared Key after power cycle.



Note •

- For printer support, see [SGD Command Support on page 1267](#).
- For details on SGD command structure, see [Command Structure on page 635](#).

wlan.bssid

Description This command returns the MAC address of the access point (AP) with which the printer is associated.

Type `getvar`

Commands	Details
<code>getvar</code>	This command retrieves the MAC address of the access point (AP). <i>Format: ! U1 getvar "wlan.bssid"</i>



Example • In this example, the `getvar` result is the MAC address of the access point.

```
! U1 getvar "wlan.bssid"
```



Note •

- For printer support, see [SGD Command Support on page 1267](#).
- For details on SGD command structure, see [Command Structure on page 635](#).

wlan.channel

Description This command retrieves the current WI-FI channel the printer is using.

Type `getvar`

Commands	Details
<code>getvar</code>	This command retrieves the current WI-FI channel the printer is using. <i>Format:</i> <code>! U1 getvar "wlan.channel"</code>



Example • In this example, the `getvar` retrieves the current WI-FI channel the printer is using.

```
! U1 getvar "wlan.channel"
```



Note •

- For printer support, see [SGD Command Support on page 1267](#).
- For details on SGD command structure, see [Command Structure on page 635](#).

wlan.channel_mask

Description This command specifies the wireless channel masks for enabling and disabling various channels. This controls which b/g radio channels can be used by the radio for network connections.

The value for this command is a bit field where a 0 disables a channel and a 1 enables the channel. Starting from the right, bit 0 is for channel 1, bit 1 for channel 2, etc. This can be used to limit the channels scanned for networks, which may slightly improve connection and roaming speed. It also used to ensure compliance with the regulatory domains of your location.

Commonly Used Channel Mask Settings

Region	Channels	Channel Mask
United States, Canada, Latin America	1 - 11	0x7FF
Europe, Middle East, Africa, other	1 - 13	0x1FFF
Japan	1 - 14	0x3FFF



Note • This command is not supported by all radios. Ensure the channel masks are set in accordance with the regulatory domains of your country.

Type setvar;getvar

Commands	Details
setvar	This command instructs the printer to set the wireless channel mask value. <i>Format:</i> ! U1 setvar "wlan.channel_mask" "value" <i>Values:</i> "0x0000" to "0xFFFF" (4 hexadecimal digits preceded by "0x") <i>Default:</i> "0x7FF"
getvar	This command instructs the printer to respond with the wireless channel mask value. <i>Format:</i> ! U1 getvar "wlan.channel_mask"



Example 1 • This setvar example shows the value set to "0x7FF" for common North American channels.

```
! U1 setvar "wlan.channel_mask" "0x7FF"
```



Example 2 • This setvar example sets the channel mask to use only channels 1,6,11.

```
! U1 setvar "wlan.channel_mask" "0x421"
```

Result: Only channels 1, 6, and 11 will be used by the radio.



Note •

- For printer support, see [SGD Command Support on page 1267](#).
- For details on SGD command structure, see [Command Structure on page 635](#).

wlan.country_code

Description This command defines the regulatory country for which the radio is currently configured.

Supported Devices

- QLn™ series

Type setvar;getvar

Commands	Details
setvar	This command sets the country code for which the radio is to be configured. ! U1 setvar "wlan.country_code" "value" <i>Values:</i> The country code choices available will vary depending on the region for which your printer is configured.
getvar	This command retrieves the country code for which the radio is currently configured. ! U1 getvar "wlan.country_code"



Example • In this example, the `setvar` sets the country code to USA/Canada.

```
! U1 setvar "wlan.country_code" "usa/canada"
```



Note •

- For printer support, see [SGD Command Support on page 1267](#).
- For details on SGD command structure, see [Command Structure on page 635](#).

wlan.current_tx_rate

Description This command retrieves the transmission rate of the wireless print server.

Type `getvar`

Commands	Details
<code>getvar</code>	This command instructs the printer to retrieve the current transmit rate of the wireless print server. <i>Format:</i> <code>! U1 getvar "wlan.current_tx_rate"</code>



Example • In this example, the `getvar` retrieves the transmission rate of the wireless print server.

```
! U1 getvar "wlan.current_tx_rate"
```



Note •

- For printer support, see [SGD Command Support on page 1267](#).
- For details on SGD command structure, see [Command Structure on page 635](#).

wlan.encryption_index

Description This parameter refers to the WEP (Wired Equivalent Privacy) encryption key index. It determines which one of the four encryption keys is to be used by the client (printer).

Type setvar;setvar

Commands	Details
setvar	This command instructs the printer to set the encryption key index the specified value. <i>Format:</i> ! U1 setvar "wlan.encryption_index" "value" <i>Values:</i> "1" "2" "3" "4" <i>Default:</i> "1"
getvar	This command instructs the printer to retrieve the current encryption key setting. <i>Format:</i> ! U1 getvar "wlan.encryption_index"



Example • In this example, the `setvar` command instructs the printer to set the encryption key index to 1.

```
! U1 setvar "encryption_index" "1"
```



Note •

- For printer support, see [SGD Command Support on page 1267](#).
- For details on SGD command structure, see [Command Structure on page 635](#).

wlan.encryption_key[1|2|3|4]1

Description These parameters refer to the first, second, third, and fourth indexed WEP encryption keys. The WEP encryption keys are hexadecimal strings that are either 10 or 26 characters long depending on the encryption method (40-bit or 128 bit). The keys should match the wireless network WEP encryption keys.

Type setvar;setvar

Commands	Details
setvar	This command instructs the printer to set the encryption key value. <i>Format:</i> ! U1 setvar "wlan.encryption_key[1 2 3 4]" "value" <i>Values:</i> 10 hexadecimal characters for 40-bit encryption and 26 hexadecimal characters for 128-bit encryption. <i>Default:</i> All zeroes (10 or 26, depending on encryption setting)
getvar	This command instructs the printer respond with the encryption key value. <i>Format:</i> ! U1 getvar "wlan.encryption_key1"

➔ **Example 1** • In these examples, the `getvar` results assume that the printer is using 40-bit encryption with the default settings.

```
! U1 getvar "wlan.encryption_key1"
! U1 getvar "wlan.encryption_key2"
! U1 getvar "wlan.encryption_key3"
! U1 getvar "wlan.encryption_key4"
```

Results for each key: "000000000"

➔ **Example 2** • In these examples, the `setvar` command instructs the printer to set the encryption key value. This example assumes that the printer is using 40-bit encryption.

```
! U1 setvar "wlan.encryption_key1" "A1B2C3D4F5"
! U1 setvar "wlan.encryption_key2" "G1H2J3K4L5"
! U1 setvar "wlan.encryption_key3" "M1N2P3Q4R5"
! U1 setvar "wlan.encryption_key4" "S1T2V3W4X5"
```



Note •

- For printer support, see [SGD Command Support on page 1267](#).
- For details on SGD command structure, see [Command Structure on page 635](#).

wlan.encryption_mode

Description This parameter refers to WEP (Wired Equivalent Privacy) encryption. This parameter enables and disables the printer’s WEP encryption. When using WEP encryption make sure that the encryption key matches the wireless network WEP encryption key.

Type setvar;getvar

Commands	Details
setvar	<p>This command instructs the printer to turn the LEAP mode "on" or "off".</p> <p><i>Format:</i> ! U1 setvar "wlan.encryption_mode" "value"</p> <p><i>Values:</i></p> <p style="padding-left: 20px;">"off"</p> <p style="padding-left: 20px;">"40-bit"</p> <p style="padding-left: 20px;">"128-bit"</p> <p><i>Default:</i> "off"</p>
getvar	<p>This command returns the type of encryption that is currently being used by the printer.</p> <p><i>Format:</i> ! U1 getvar "wlan.encryption_mode"</p>

➔ **Example 1** • This example instructs the printer to set encryption to 40-bit.
! U1 setvar "wlan.encryption_mode" "40-bit"

➔ **Example 2** • This example instructs the printer to turn encryption off.
! U1 setvar "wlan.encryption_mode" "off"



Note •

- For printer support, see [SGD Command Support on page 1267](#).
- For details on SGD command structure, see [Command Structure on page 635](#).

wlan.essid

Description This printer setting refers to the printer’s stored ESSID. Setting the ESSID to "" will set the printer in a "broadcast" mode.

Type setvar;getvar

Commands	Details
setvar	This command instructs the printer to change the ESSID. <i>Format:</i> ! U1 setvar "wlan.essid" "value" <i>Values:</i> 32 character alphanumeric string <i>Default:</i> "125"
getvar	This command instructs the printer to respond with the stored ESSID value. <i>Format:</i> ! U1 getvar "wlan.essid"



Example • This `setvar` example shows the value set to "125".

```
! U1 setvar "wlan.essid" "125"
```

When the `setvar` value is set to "125", the `getvar` result is "125".



Note •

- For printer support, see [SGD Command Support on page 1267](#).
- For details on SGD command structure, see [Command Structure on page 635](#).

wlan.firmware_version

Description This command refers to the firmware version of the wireless radio card.

Type `getvar`

Commands	Details
<code>getvar</code>	This command instructs the printer to respond with the current version of the wireless radio card firmware. <i>Format:</i> <code>! U1 getvar "wlan.firmware_version"</code>



Example • In this example, the `getvar` result is the version of Symbol 4137 card (for example, "F3.91-69").

```
! U1 getvar "wlan.firmware_version"
```



Note •

- For printer support, see [SGD Command Support on page 1267](#).
- For details on SGD command structure, see [Command Structure on page 635](#).

wlan.ip.addr

Description This command allows you to get or set the wireless print servers's IP address.



Important • For a set IP address to take affect, the IP protocol must be set to permanent and the print server must be reset.

Type `setvar;getvar`

Commands	Details
<code>setvar</code>	<p>This command instructs the printer to change its current wireless print server IP address upon powering the printer on.</p> <p><i>Format:</i> <code>! U1 setvar "wlan.ip.addr" "value"</code></p> <p><i>Values:</i> any valid IP address</p> <p><i>Default:</i> <code>"0.0.0.0"</code></p> <p> Note • The <code>setvar</code> value of this command can be affected by the <code>wlan.ip.dhcp.enable</code> command.</p>
<code>getvar</code>	<p>This command instructs the printer to respond with its current wireless print server IP address.</p> <p><i>Format:</i> <code>! U1 getvar "wlan.ip.addr"</code></p>



Example • This `setvar` example shows the value set to `"10.14.4.235"`.

```
! U1 setvar "wlan.ip.addr" "10.14.4.235"
```

What the `setvar` value is set to is the `getvar` result. In this example, the `getvar` result is `"10.14.4.235"`.



Note •

- For printer support, see [SGD Command Support on page 1267](#).
- For details on SGD command structure, see [Command Structure on page 635](#).

wlan.ip.arp_interval

Description This print server setting allows you to specify the ARP (Address Resolution Protocol) interval or the ARP cache time out for the wireless print server.

Type setvar;setvar

Commands	Details
setvar	This command instructs the printer to respond with the ARP interval or the ARP cache time out value for the wireless print server. <i>Format:</i> ! U1 setvar "wlan.ip.arp_interval" "value" <i>Values:</i> 0 to 30 seconds <i>Default:</i> "0"
getvar	This command instructs the printer to respond with the ARP interval or the ARP cache time out value (in seconds) for the wireless print server. <i>Format:</i> ! U1 getvar "wlan.ip.arp_interval"



Example • This setvar example shows the value set to "0".

```
! U1 setvar "wlan.ip.arp_interval" "0"
```

What the setvar value is set to is the getvar result. In this example, the getvar result is "0".



Note •

- For printer support, see [SGD Command Support on page 1267](#).
- For details on SGD command structure, see [Command Structure on page 635](#).

wlan.ip.default_addr_enable

Description This command allows you to default the wireless print server’s IP address.



Important • For a set IP address to take affect, the IP protocol must be set to permanent and the print server must be reset.

Type `setvar;getvar`

Commands	Details
<code>setvar</code>	<p>This command tells the printer to use it’s default address, if no address is provided through DHCP or BOOTP. If you do not assign an IP address after 2 minutes, the 10/100 Internal PS defaults to IP address 192.168.254.254.</p> <p><i>Format:</i> <code>! U1 setvar "wlan.ip.default_addr_enable" "value"</code></p> <p><i>Values:</i></p> <ul style="list-style-type: none"> "on" = enabled "off" = disabled <p><i>Default:</i> "on"</p>
<code>getvar</code>	<p>This command instructs the printer to show the status of the setting of the wireless print server’s default IP address feature.</p> <p><i>Format:</i> <code>! U1 getvar "wlan.ip.default_addr_enable"</code></p>



Example • This `setvar` example shows the value set to "on".

```
! U1 setvar "wlan.ip.default_addr_enable" "on"
```

What the `setvar` value is set to is the `getvar` result. In this example, the `getvar` result is "on".



Note •

- For printer support, see [SGD Command Support on page 1267](#).
- For details on SGD command structure, see [Command Structure on page 635](#).

wlan.ip.dhcp.cache_ip

Description This command enables or disables the IP cache of the wireless print server.

Type setvar;getvar

Commands	Details
setvar	This command sets the status of the IP cache. <i>Format:</i> ! U1 setvar "ip.dhcp.cache_ip" "value" <i>Values:</i> "on" = enabled "off" = disabled <i>Default:</i> "off"
getvar	This command retrieves the status of the IP cache. <i>Format:</i> ! U1 getvar "wlan.ip.dhcp.cache_ip"



Example • This setvar example shows the value set to "off".

```
! U1 setvar "wlan.ip.dhcp.cache_ip" "off"
```

When the setvar value is set to "off", the getvar result is "off".



Note •

- For printer support, see [SGD Command Support on page 1267](#).
- For details on SGD command structure, see [Command Structure on page 635](#).

wlan.ip.dhcp.cid_all

Description This printer setting defines the entire client identifier (DHCP option 61) if DHCP is enabled on the wireless print server and "wlan.ip.dhcp.cid_type" is set to "0", or "2". The MAC address is used if the type is set to "1".

Type setvar;getvar

Commands	Details
setvar	<p>This command instructs the printer to change the client identifier prefix and suffix of the wireless print server. The prefix gets cleared and the suffix contains the entire client identifier.</p> <p><i>Format:</i> ! U1 setvar "wlan.ip.dhcp.cid_all" "value"</p> <p><i>Values:</i> A maximum length of 60 characters if the CID type is ASCII, or 120 characters if the CID type is hexadecimal.</p> <p><i>Default Value:</i> ""</p>
getvar	<p>This command instructs the printer to respond with the client identifier prefix and suffix of the wireless print server.</p> <p><i>Format:</i> ! U1 getvar "wlan.ip.dhcp.cid_all"</p>



Example • This `setvar` example shows the value set to "printer".

```
! U1 setvar "wlan.ip.dhcp.cid_all" "printer"
```

What the `setvar` value is set to is the `getvar` result. In this example, the `getvar` result is "printer".



Note •

- For printer support, see [SGD Command Support on page 1267](#).
- For details on SGD command structure, see [Command Structure on page 635](#).

wlan.ip.dhcp.cid_enable

Description This command determines if DHCP (option 61) is turned on or off of the wireless print server.

Type setvar;setvar

Commands	Details
setvar	<p>This command instructs the printer to set the status of the client identifier of the wireless print server.</p> <p><i>Format:</i> ! U1 setvar "wlan.ip.dhcp.cid_enable" "value"</p> <p><i>Values:</i></p> <ul style="list-style-type: none">"off" = client identifier is turned off"on" = client identifier is turned on <p><i>Default:</i> "off"</p>
getvar	<p>This command instructs the printer to respond with the status of the client identifier of the wireless print server.</p> <p><i>Format:</i> ! U1 getvar "wlan.ip.dhcp.cid_enable"</p>



Example • This `setvar` example shows the value set to "off".

```
! U1 setvar "wlan.ip.dhcp.cid_enable" "off"
```

What the `setvar` value is set to is the `getvar` result. In this example, the `getvar` result is "off".



Note •

- For printer support, see [SGD Command Support on page 1267](#).
- For details on SGD command structure, see [Command Structure on page 635](#).

wlan.ip.dhcp.cid_prefix

Description This printer setting defines the prefix to be prepended to the DHCP client identifier (option 61) when DHCP is enabled on the wireless print server and "wlan.ip.dhcp.cid_type" is set to "0" or "2".

Type setvar;getvar

Commands	Details
setvar	This command instructs the printer to change the CID prefix of the wireless print server. <i>Format:</i> ! U1 setvar "wlan.ip.dhcp.cid_prefix" "value" <i>Values:</i> Any text string up to 10 characters if the CID type is ASCII, or 20 characters if the CID type is hexadecimal. <i>Default Value:</i> ""
getvar	This command instructs the printer to respond with the client identifier prefix of the wireless print server. <i>Format:</i> ! U1 getvar "wlan.ip.dhcp.cid_prefix"



Example • This `setvar` example shows the value set to "PRT001".

```
! U1 setvar "wlan.ip.dhcp.cid_prefix" "PRT001"
```

What the `setvar` value is set to is the `getvar` result. In this example, the `getvar` result is "PRT001".



Note •

- For printer support, see [SGD Command Support on page 1267](#).
- For details on SGD command structure, see [Command Structure on page 635](#).

wlan.ip.dhcp.cid_suffix

Description This printer setting defines the unique suffix to be used as the client identifier (DHCP option 61) if DHCP is enabled on the wireless print server and "wlan.ip.dhcp.cid_type" is set to "0" or "2".

Type setvar;getvar

Commands	Details
setvar	<p>This command instructs the printer to change the client identifier suffix value on the wireless print server.</p> <p><i>Format:</i> ! U1 setvar "wlan.ip.dhcp.cid_suffix" "value"</p> <p><i>Values:</i> The maximum length of a value allowed is 60 ASCII characters when the CID type is ASCII, or 120 hexadecimal values when the CID type is hexadecimal.</p> <p><i>Default:</i> ""</p>
getvar	<p>This command instructs the printer to respond with the client identifier suffix on the wireless print server.</p> <p><i>Format:</i> ! U1 getvar "wlan.ip.dhcp.cid_suffix"</p>



Example • This `setvar` example shows the value set to "printer".

```
! U1 setvar "wlan.ip.dhcp.cid_suffix" "printer"
```

What the `setvar` value is set to is the `getvar` result. In this example, the `getvar` result is "printer".



Note •

- For printer support, see [SGD Command Support on page 1267](#).
- For details on SGD command structure, see [Command Structure on page 635](#).

wlan.ip.dhcp.cid_type

Description This printer setting defines the type of client identifier (DHCP option 61) that will be sent if DHCP is enabled on the wireless print server. A value of "1" means the type of "Ethernet" and the printer's MAC address will be used. A value of "0" or "2" means the client identifier sent will be "wlan.ip.dhcp.cid_prefix" concatenated with "wlan.ip.dhcp.cid_suffix".

Type setvar;getvar

Commands	Details
setvar	<p>This command instructs the printer to enable "synthetic" client identifier for the wireless print server.</p> <p><i>Format:</i> ! U1 setvar "wlan.ip.dhcp.cid_type" "value"</p> <p><i>Values:</i></p> <ul style="list-style-type: none"> "0" = ASCII string "1" = wireless radio card's MAC address "2" = HEX value <p><i>Default Value:</i> "1"</p>
getvar	<p>This command instructs the printer to respond with the client identifier type for the wireless print server.</p> <p><i>Format:</i> ! U1 getvar "wlan.ip.dhcp.cid_type"</p>



Example • This `setvar` example shows the value set to "1".

```
! U1 setvar "wlan.ip.dhcp.cid_type" "1"
```

What the `setvar` value is set to is the `getvar` result. In this example, the `getvar` result is "1".



Note •

- For printer support, see [SGD Command Support on page 1267](#).
- For details on SGD command structure, see [Command Structure on page 635](#).

wlan.ip.dhcp.lease.last_attempt

Description This command retrieves the last time a DHCP request was sent from the wireless print server.

Type `getvar`

Commands	Details
<code>getvar</code>	This command retrieves the last time a DHCP request was sent from the wireless print server. <i>Format:</i> <code>! U1 getvar "wlan.ip.dhcp.lease.last_attempt"</code>



Example • In this example, the `getvar` retrieves the last time a DHCP request was sent from the wireless print server.

```
! U1 getvar "wlan.ip.dhcp.lease.last_attempt"
```



Note •

- For printer support, see [SGD Command Support on page 1267](#).
- For details on SGD command structure, see [Command Structure on page 635](#).

wlan.ip.dhcp.lease.length

Description This command retrieves the original length (in seconds) of the DHCP lease on the wireless print server.

Type `getvar`

Commands	Details
<code>getvar</code>	This command retrieves the original length (in seconds) of the DHCP lease on the wireless print server. <i>Format:</i> <code>! U1 getvar "wlan.ip.dhcp.lease.length"</code>



Example • This command retrieves the original length of the DHCP lease on the wireless print server.

```
! U1 getvar "wlan.ip.dhcp.lease.length"
```



Note •

- For printer support, see [SGD Command Support on page 1267](#).
- For details on SGD command structure, see [Command Structure on page 635](#).

wlan.ip.dhcp.lease.server

Description This command retrieves the address of the print server that provided the DHCP lease on the wireless print server.

Type `getvar`

Commands	Details
<code>getvar</code>	This command retrieves the address of the print server that provided the DHCP lease on the wireless print server. <i>Format:</i> <code>! U1 getvar "wlan.ip.dhcp.lease.server"</code>



Example • In this example, the `getvar` retrieves the server that provided the DHCP lease on the wireless print server.

```
! U1 getvar "wlan.ip.dhcp.lease.server"
```



Note •

- For printer support, see [SGD Command Support on page 1267](#).
- For details on SGD command structure, see [Command Structure on page 635](#).

wlan.ip.dhcp.lease.time_left

Description This command retrieves the time (in seconds) left in the current DHCP lease on the wireless print server.

Type `getvar`

Commands	Details
<code>getvar</code>	This command retrieves the time (in seconds) left in the current DHCP lease on the wireless print server. <i>Format:</i> <code>! U1 getvar "wlan.ip.dhcp.lease.time_left"</code>



Example • In this example, the `getvar` retrieves the time left in the current DHCP lease on the wireless print server.

```
! U1 getvar "wlan.ip.dhcp.lease.time_left"
```



Note •

- For printer support, see [SGD Command Support on page 1267](#).
- For details on SGD command structure, see [Command Structure on page 635](#).

wlan.ip.dhcp.option12

Description This command specifies if the DHCP option 12 (host name) is on or off in the discovery packet that is sent from the wireless print server.

Type setvar;getvar

Commands	Details
setvar	<p>This command instructs the printer to set the DHCP option 12 (host name) is on or off in the discovery packet that is sent from the wireless print server.</p> <p><i>Format:</i> ! U1 setvar "wlan.ip.dhcp.option12" "value"</p> <p><i>Values:</i></p> <ul style="list-style-type: none">"on" = turns on option 12"off" = turns off option 12 <p><i>Default Value:</i> "on"</p>
getvar	<p>This command retrieves the status of the DHCP option 12 (host name) is on or off in the discovery packet that is sent from the wireless print server.</p> <p><i>Format:</i> ! U1 getvar "wlan.ip.dhcp.option12"</p>



Example • This setvar example shows the value set to "on".

```
! U1 setvar "wlan.ip.dhcp.option12" "on"
```

When the setvar value is set to "on", the getvar result is "on".



Note •

- For printer support, see [SGD Command Support on page 1267](#).
- For details on SGD command structure, see [Command Structure on page 635](#).

wlan.ip.dhcp.option12_format

Description This command specifies the format of the option 12 value to be used in the discovery packet of the wireless print server.

Type setvar;getvar

Commands	Details
setvar	This command instructs the printer to set the format of option 12 value to be used in the discovery packet of the wireless print server. <i>Format:</i> ! U1 setvar "wlan.ip.dhcp.option12_format" "value" <i>Values:</i> string <i>Default Value:</i> ""
getvar	This command retrieves the format of option 12 value to be used in the discovery packet of the wireless print server. <i>Format:</i> ! U1 getvar "wlan.ip.dhcp.option12_format"



Example • This `setvar` example shows configuring the `wlan.ip.dhcp.option12_format` to the value contained in the `device.friendly_name`.

It is necessary to surround the SGD entry to be used as source for the data with the `<` and `>` characters.

```
! U1 setvar "wlan.ip.dhcp.option12_format" "<device.friendly_name>"
```

To further explain, if the above command was issued and the value currently stored in the `device.friendly_name` parameter was "ShipPrinter", then the response to following command would be "ShipPrinter":

```
! U1 getvar "wlan.ip.dhcp.option12_value"
```



Note •

- For printer support, see [SGD Command Support on page 1267](#).
- For details on SGD command structure, see [Command Structure on page 635](#).

wlan.ip.dhcp.option12_value

Description This command retrieves the actual value which will be used in the discovery packet of the wireless print server.

Type `getvar`

Commands	Details
<code>getvar</code>	This command retrieves the actual value which will be used in the discovery packet of the wireless print server. <i>Format: ! U1 getvar "wlan.ip.dhcp.option12_value"</i>



Example • This `setvar` example shows configuring the `wlan.ip.dhcp.option12_format` to the value contained in the `device.friendly_name`.

It is necessary to surround the SGD entry to be used as source for the data with the `<` and `>` characters.

```
! U1 setvar "wlan.ip.dhcp.option12_format" "<device.friendly_name>"
```

To further explain, if the above command was issued and the value currently stored in the `device.friendly_name` parameter was "ShipPrinter", then the response to following command would be "ShipPrinter":

```
! U1 getvar "wlan.ip.dhcp.option12_value"
```



Note •

- For printer support, see [SGD Command Support on page 1267](#).
- For details on SGD command structure, see [Command Structure on page 635](#).

wlan.ip.dhcp.request_timeout

Description This command sets the maximum time (in seconds) to wait for a response to a DHCP discovery request on the wireless print server.

Type setvar;getvar

Commands	Details
setvar	<p>This command instructs the printer to set the maximum time (in seconds) to wait for a response to a DHCP discovery request on the wireless print server.</p> <p><i>Format:</i> ! U1 setvar "wlan.ip.dhcp.request_timeout" "value"</p> <p><i>Values:</i> "2" through "30"</p> <p><i>Default:</i> "2"</p>
getvar	<p>This command retrieves the maximum time (in seconds) to wait for a response to a DHCP discovery request on the wireless print server.</p> <p><i>Format:</i> ! U1 getvar "wlan.ip.dhcp.request_timeout"</p>



Example • This `setvar` example shows the value set to "2".

```
! U1 setvar "wlan.ip.dhcp.request_timeout" "2"
```

When the `setvar` value is set to "2", the `getvar` result is "2".



Note •

- For printer support, see [SGD Command Support on page 1267](#).
- For details on SGD command structure, see [Command Structure on page 635](#).

wlan.ip.dhcp.requests_per_session

Description This command retrieves the maximum amount of DHCP discover requests for a single DHCP session on the wireless print server.

Type setvar;setvar

Commands	Details
setvar	This command instructs the printer to set the maximum amount of DHCP discover requests for a single DHCP session on the wireless print server. <i>Format:</i> ! U1 setvar "wlan.ip.dhcp.requests_per_session" "value" <i>Values:</i> "1" through "10" <i>Default:</i> "2"
getvar	This command retrieves the currently set maximum amount of DHCP discover requests for a single DHCP session on the wireless print server. <i>Format:</i> ! U1 getvar "wlan.ip.dhcp.requests_per_session"



Example • This `setvar` example shows the value set to "2".

```
! U1 setvar "wlan.ip.dhcp.requests_per_session" "2"
```

When the `setvar` value is set to "2", the `getvar` result is "2".



Note •

- For printer support, see [SGD Command Support on page 1267](#).
- For details on SGD command structure, see [Command Structure on page 635](#).

wlan.ip.dhcp.session_interval

Description This command retrieves how long it will take for a DHCP session to time out before a new DHCP session begins on the wireless print server.

Type setvar;getvar

Commands	Details
setvar	This command instructs the printer to set the DHCP session time out. <i>Format:</i> ! U1 setvar "wlan.ip.dhcp.session_interval" "value" <i>Values:</i> "0" through "60" <i>Default:</i> "10"
getvar	This command retrieves the current DHCP session time out. <i>Format:</i> ! U1 getvar "wlan.ip.dhcp.session_interval"



Example • This `setvar` example shows the value set to "10".

```
! U1 setvar "wlan.ip.dhcp.session_interval" "10"
```

When the `setvar` value is set to "10", the `getvar` result is "10".



Note •

- For printer support, see [SGD Command Support](#) on page 1267.
- For details on SGD command structure, see [Command Structure](#) on page 635.

wlan.ip.dns.servers

Description This command retrieves a space delimited list of the domain name servers from a wlan print server.

Type `getvar`

Commands	Details
<code>getvar</code>	This command retrieves a list of space delimited DNS wlan print servers. <i>Format: ! U1 getvar "wlan.ip.dns.servers"</i>



Note •

- For printer support, see [SGD Command Support on page 1267](#).
- For details on SGD command structure, see [Command Structure on page 635](#).

wlan.ip.gateway

Description This command instructs the printer to change the wireless print server's gateway address.



Note • This setting refers to the gateway address. A set value is ignored if the IP protocol is not set to permanent.

Type setvar;getvar

Commands	Details
setvar	This command instructs the printer to change the wireless printer server's gateway address. <i>Format:</i> ! U1 setvar "wlan.ip.gateway" "value" <i>Values:</i> Any valid gateway address <i>Default:</i> "0.0.0.0"
getvar	This command instructs the printer to respond with the wireless printer server's gateway address. <i>Format:</i> ! U1 getvar "wlan.ip.gateway"



Example • This `setvar` example shows the value set to "10.3.5.1".

```
! U1 setvar "wlan.ip.gateway" "10.3.5.1"
```

When the `setvar` value is set to "10.3.5.1", the `getvar` result is "10.3.5.1".



Note •

- For printer support, see [SGD Command Support](#) on page 1267.
- For details on SGD command structure, see [Command Structure](#) on page 635.

wlan.ip.netmask

Description This setting refers to the wireless print server's subnet mask address. This value is ignored if the IP protocol is not set to permanent.

Type setvar;setvar

Commands	Details
setvar	This command instructs the printer to change the wireless print servers's subnet mask. <i>Format:</i> ! U1 setvar "wlan.ip.netmask" "value" <i>Values:</i> Any valid subnet mask. <i>Default:</i> "255.255.255.0"
getvar	This command instructs the printer to respond with wireless print server's subnet mask. <i>Format:</i> ! U1 getvar "wlan.ip.netmask"



Example • This `setvar` example shows the value set to "255.255.255.0".

```
! U1 setvar "wlan.ip.netmask" "255.255.255.0"
```

When the `setvar` value is set to "255.255.255.0", the `getvar` result is "255.255.255.0".



Note •

- For printer support, see [SGD Command Support on page 1267](#).
- For details on SGD command structure, see [Command Structure on page 635](#).

wlan.ip.port

Description This printer setting refers to the wireless print server’s port number that the TCP print service is listening on. Normal TCP communications from the host should be directed to this port.

Type setvar;getvar

Commands	Details
setvar	This command instructs the printer to set the wireless print server’s TCP/UDP port number. <i>Format:</i> ! U1 setvar "wlan.ip.port" "value" <i>Values:</i> 1 - 65535 (excluding any ports currently used by other services, such as 21, 23, 80, and 515). <i>Default:</i> "9100"
getvar	This command instructs the printer to respond with the wireless printer server’s TCP/UDP port number. <i>Format:</i> ! U1 getvar "wlan.ip.port"



Example • This `setvar` example shows the value set to "9100".

```
! U1 setvar "wlan.ip.port" "9100"
```

When the `setvar` value is set to "9100", the `getvar` result is "9100".



Note •

- For printer support, see [SGD Command Support on page 1267](#).
- For details on SGD command structure, see [Command Structure on page 635](#).

wlan.ip.port_alternate

Description This command sets the port number of the alternate wlan port.



Note • Print servers supporting this command will monitor both the primary port and the alternate port for connections at the same time.

Supported Devices ZT200 Series

Type setvar;setvar

Commands	Details
setvar	This command sets the alternate wlan port for the print server. <i>Format:</i> ! U1 setvar "wlan.ip.port_alternate" "value" <i>Values:</i> Any valid TCP port address. <i>Default:</i> 9100
getvar	This command returns the current alternate wlan port setting. <i>Format:</i> ! U1 getvar "wlan.ip.port_alternate" <i>Values:</i> The current port setting.



Example 1 • This setvar example shows the value set to "6101".

```
U1 setvar "wlan.ip.port_alternate" "6101"
```



Example 2 • This setvar example sets the channel mask to use only channels 1,6,11.

```
! U1 setvar "wlan.channel_mask" "0x421"
```

Result: Only channels 1, 6, and 11 will be used by the radio.



Note •

- For printer support, see [SGD Command Support on page 1267](#).
- For details on SGD command structure, see [Command Structure on page 635](#).

wlan.ip.port_json_config

Description This command determines the TCP port number to listen on for JSON configuration packets.

Supported Devices

- iMZ 220™, iMZ 320™
- QLn220™, QLn320™, QLn420™
- ZT210™, ZT220™, ZT230™

Type setvar; getvar

Commands	Details
setvar	<p>This command determines the TCP port number on which to listen for JSON configuration packets.</p> <p><i>Format:</i> ! U1 setvar "wlan.ip.port_json_config" "value"</p> <p><i>Values:</i> Any valid port number except ports already in use or the standard network ports.</p> <ul style="list-style-type: none"> • 0 = disable the port • 1-65535 = port number to listen on. <p><i>Default:</i> "9200"</p>
getvar	<p>This command retrieves the TCP port number which is listening for JSON configuration packets.</p> <p><i>Format:</i> ! U1 getvar "wlan.ip.port_json_config"</p>



Example • In this example, the `getvar` command causes the printer to get the TCP port number which is listening for JSON configuration packets.

```
! U1 getvar "wlan.ip.port_json_config"
```



Note

- For printer support, see [SGD Command Support on page 1267](#).
- For details on SGD command structure, see [Command Structure on page 635](#).

wlan.ip.protocol

Description This command configures the IP addressing method used by the wireless print server.

Type setvar;getvar

Commands	Details
setvar	<p>This command instructs the printer to configure the IP addressing method used by the wireless print server.</p> <p><i>Format:</i> ! U1 setvar "wlan.ip.protocol" "value"</p> <p><i>Values:</i></p> <ul style="list-style-type: none"> "bootp" = uses the standard bootp addressing method to obtain an IP address and configuration "dhcp" = uses the standard dhcp addressing method to obtain an IP address and configuration for a server specified period of time "rarp" = uses the standard rarp addressing method to obtain an IP address "glean only" = uses the IP address from a PING packet that is sent to its hardware address (unicast address) "permanent" = uses static values assigned through other commands "all" = tries all of the dynamic addressing methods, not permanent, to obtain an IP address <p><i>Default:</i> "all"</p>
getvar	<p>This command returns the value of the currently selected IP protocol used by the wireless print server.</p> <p><i>Format:</i> ! U1 getvar "wlan.ip.protocol"</p>



Example • In this example, the `setvar` result is the current programming language that the printer is using.

```
! U1 setvar "wlan.ip.protocol" "bootp"
```

What the `setvar` value is set to is the `getvar` result. In this example, the `getvar` result is "bootp".



Note •

- For printer support, see [SGD Command Support on page 1267](#).
- For details on SGD command structure, see [Command Structure on page 635](#).

wlan.ip.timeout.enable

Description This network setting refers to enabling the connection timeout on the wireless print server. For this to take effect, the print server must be reset.

Type setvar;setvar

Commands	Details
setvar	<p>This command instructs the printer to enable or disable the timeout checking on the wireless print server.</p> <p><i>Format:</i> ! U1 setvar "wlan.ip.timeout.enable" "value"</p> <p><i>Values:</i></p> <ul style="list-style-type: none"> "off" = turns off the connection checking "on" = turns on the connection checking <p><i>Default:</i> "on"</p>
getvar	<p>This command instructs the printer to return whether the timeout checking is enabled on the wireless print server.</p> <p><i>Format:</i> ! U1 getvar "wlan.ip.timeout.enable"</p>



Example • This setvar example shows the value set to "on".

```
! U1 setvar "wlan.ip.timeout.enable" "on"
```

When the setvar value is set to "on", the getvar result is "on".



Note •

- For printer support, see [SGD Command Support on page 1267](#).
- For details on SGD command structure, see [Command Structure on page 635](#).

wlan.ip.timeout.value

Description This network setting refers to the number of seconds before the connection times out for the wireless print server. For this to take effect, the print server must be reset.

Type setvar;setvar

Commands	Details
setvar	This command instructs the printer to set the the time value of the wireless print server, in seconds, before the connection times out. <i>Format:</i> ! U1 setvar "wlan.ip.timeout.value" "value" <i>Values:</i> "1" through "3600" <i>Default:</i> "300"
getvar	This command instructs the printer to respond with the time, in seconds, before the connection times out. <i>Format:</i> ! U1 getvar "wlan.ip.timeout.value"



Example • This `setvar` example shows the value set to "300".

```
! U1 setvar "wlan.ip.timeout.value" "300"
```

When the `setvar` value is set to "300", the `getvar` result is "300".



Note •

- For printer support, see [SGD Command Support on page 1267](#).
- For details on SGD command structure, see [Command Structure on page 635](#).

wlan.keep_alive.enable

Description This setting controls the printers ability to send a LSAP (link service access point) packet to the access point on an user controllable interval. This feature is included to accommodate access points that require a regular confirmation that wireless clients are still active.

Type setvar;getvar

Commands	Details
setvar	<p>This command instructs the printer to send a LSAP (link service access point) packet to the access point on an user controllable interval.</p> <p><i>Format:</i> ! U1 setvar "wlan.keep_alive.enable" "value"</p> <p><i>Values:</i></p> <ul style="list-style-type: none"> "on" = turns on keep_alive "off" = turns off keep_alive <p><i>Default:</i> "on"</p>
getvar	<p>This command instructs the printer to respond with the wlan.keep_alive.enable setting.</p> <p><i>Format:</i> ! U1 getvar "wlan.keep_alive.enable"</p>



Example • This setvar example shows the value set to "on".

```
! U1 setvar "wlan.keep_alive.enable" "on"
```

When the setvar value is set to "on", the getvar result is "on".



Note •

- For printer support, see [SGD Command Support on page 1267](#).
- For details on SGD command structure, see [Command Structure on page 635](#).

wlan.keep_alive.timeout

Description This printer setting manages the interval at which the LSAP (link service access point) packet is sent.

Type setvar;setvar

Commands	Details
setvar	This command instructs the printer to configure the frequency at which the printer sends the wlan.keep_alive packet. <i>Format:</i> ! U1 setvar "wlan.keep_alive.timeout" "value" <i>Values:</i> 5 to 300 seconds <i>Default:</i> "15"
getvar	This command instructs the printer to respond with the wlan.keep_alive.timeout interval value. <i>Format:</i> ! U1 getvar "wlan.keep_alive.timeout"



Example • This setvar example shows the value set to "15".

```
! U1 setvar "wlan.keep_alive.timeout" "15"
```

When the setvar value is set to "15", the getvar result is "15".



Note •

- For printer support, see [SGD Command Support on page 1267](#).
- For details on SGD command structure, see [Command Structure on page 635](#).

wlan.kerberos.kdc

Description This printer setting refers to the Kerberos Key Distribution Center (KDC). The KDC is a trusted server which maintains a database with account information for all security principals (users) for a particular site or administrative domain (realm).

Type setvar;getvar

Commands	Details
setvar	This command instructs the printer to change the Kerberos KDC. <i>Format:</i> ! U1 setvar "wlan.kerberos.kdc" "value" <i>Values:</i> 0-32 ASCII characters <i>Default:</i> "krbtgt"
getvar	This command instructs the printer to respond with the current Kerberos KDC. <i>Format:</i> ! U1 getvar "wlan.kerberos.kdc"



Example • This `setvar` example shows the value set to "krbtgt".

```
! U1 setvar "wlan.kerberos.kdc" "krbtgt"
```

When the `setvar` value is set to "krbtgt", the `getvar` result is "krbtgt".



Note •

- For printer support, see [SGD Command Support on page 1267](#).
- For details on SGD command structure, see [Command Structure on page 635](#).

wlan.kerberos.mode

Description This printer setting refers to the Kerberos network authentication protocol. Kerberos provides secure mutual authentication for a wireless client through a Symbol Access Point, based on user information stored on a Kerberos KDC (Key Distribution Center) server.

Type setvar;getvar

Commands	Details
setvar	This command instructs the printer to turn Kerberos mode "on" or "off". <i>Format:</i> ! U1 setvar "wlan.kerberos.mode" "values" <i>Values:</i> "off" = disables Kerberos mode "on" = enables Kerberos mode <i>Default:</i> "off"
getvar	This command instructs the printer to respond with the current Kerberos mode. <i>Format:</i> ! U1 getvar "wlan.kerberos.mode"



Example • This setvar example shows the value set to "on".

```
! U1 setvar "wlan.kerberos.mode" "on"
```

When the setvar value is set to "on", the getvar result is "on".



Note •

- For printer support, see [SGD Command Support on page 1267](#).
- For details on SGD command structure, see [Command Structure on page 635](#).

wlan.kerberos.password

Description This printer setting refers to the Kerberos password. The password must correspond to a user profile established on the Kerberos KDC server in use.

Type setvar;getvar

Commands	Details
setvar	This command instructs the printer to set the Kerberos password. <i>Format:</i> ! U1 setvar "wlan.kerberos.password" "value" <i>Values:</i> 0-32 alphanumeric characters <i>Default:</i> "password"
getvar	This command instructs the printer to respond with the current Kerberos password. <i>Format:</i> ! U1 getvar "wlan.kerberos.password" For protection a single "*" prints.



Example • This setvar example shows the value set to "password".

```
! U1 setvar "wlan.kerberos.password" "password"
```

When the setvar value is set to "password", the getvar result is "*".



Note •

- For printer support, see [SGD Command Support on page 1267](#).
- For details on SGD command structure, see [Command Structure on page 635](#).

wlan.kerberos.realm

Description This printer setting refers to the Kerberos realm, an administrative domain with its own Kerberos server (KDC).



Important • If you are using a Windows 2000 Server the realm must be all upper-case. For details, see [Example 2](#) below.

Type setvar;getvar

Commands	Details
setvar	This command instructs the printer to change the Kerberos realm. <i>Format:</i> ! U1 setvar "wlan.kerberos.realm" "value" <i>Values:</i> 0-64 alphanumeric characters <i>Default:</i> "kerberos"
getvar	This command instructs the printer to respond with the current Kerberos realm. <i>Format:</i> ! U1 getvar "wlan.kerberos.realm"



Example 1 • This `setvar` example shows the value set to "zebra".

```
! U1 setvar "wlan.kerberos.realm" "zebra"
```

When the `setvar` value is set to "zebra", the `getvar` result is "zebra".



Example 2 • This `setvar` example shows the value set to "ZEBRA" on a Windows 2000 server.

```
! U1 setvar "wlan.kerberos.realm" "ZEBRA"
```

When the `setvar` value is set to "ZEBRA", the `getvar` result is "ZEBRA".



Note •

- For printer support, see [SGD Command Support on page 1267](#).
- For details on SGD command structure, see [Command Structure on page 635](#).

wlan.kerberos.username

Description This printer setting refers to the Kerberos user name. The user name must correspond to a user profile established on the Kerberos KDC server in use.

Type setvar;getvar

Commands	Details
setvar	This command instructs the printer to change the Kerberos user name. <i>Format:</i> ! U1 setvar "wlan.kerberos.username" "value" <i>Values:</i> 0-32 alphanumeric characters <i>Default:</i> "user"
getvar	This command instructs the printer to respond with the current Kerberos user name. <i>Format:</i> ! U1 getvar "wlan.kerberos.username"



Example • This `setvar` example shows the value set to "user".

```
! U1 setvar "wlan.kerberos.username" "user"
```

When the `setvar` value is set to "user", the `getvar` result is "user".



Note •

- For printer support, see [SGD Command Support on page 1267](#).
- For details on SGD command structure, see [Command Structure on page 635](#).

wlan.leap_mode

Description This printer setting refers to Cisco LEAP (Lightweight Extensible Authentication Protocol). LEAP provides secure mutual authentication for a wireless client through a Cisco Aironet Access Point, based on user information stored on a backend RADIUS (Remote Authentication in Dial-Up User Service) /AAA (Authentication, Authorization, and Accounting) server.



Note •

1. This command is only supported on printers using firmware Vxx.18.xx or earlier.
2. This command is not supported on units with a Frequency Hopping Spread Spectrum (FHSS) radio.

Type setvar;setvar

Commands	Details
setvar	This command instructs the printer to turn the LEAP mode "on" or "off". <i>Format:</i> ! U1 setvar "wlan.leap_mode" "values" <i>Values:</i> "off" = disables LEAP mode "on" = enables LEAP mode <i>Default:</i> "off"
getvar	This command instructs the printer to respond with the LEAP mode. <i>Format:</i> ! U1 getvar "wlan.leap_mode"



Example • This `setvar` example shows the value set to "on".

```
! U1 setvar "wlan.leap_mode" "on"
```

When the `setvar` value is set to "on", the `getvar` result is "on".



Note •

- For printer support, see [SGD Command Support on page 1267](#).
- For details on SGD command structure, see [Command Structure on page 635](#).

wlan.leap_password

Description This printer setting refers to the LEAP password. The password must correspond to a user profile established on the RADIUS/AAA server in use.



Note • This parameter is not supported on units with a Frequency Hopping Spread Spectrum (FHSS) radio.

Type `setvar;getvar`



Note •

- For printer support, see [SGD Command Support on page 1267](#).
- For details on SGD command structure, see [Command Structure on page 635](#).

wlan.leap_username

Description This printer setting refers to the LEAP user name. The user name must correspond to a user profile established on the RADIUS/AAA server in use.



Note • This parameter is not supported on units with a Frequency Hopping Spread Spectrum (FHSS) radio.

Type setvar;getvar

Commands	Details
setvar	This command instructs the printer to change the LEAP user name. <i>Format:</i> ! U1 setvar "wlan.leap_username" "values" <i>Values:</i> 0-32 alphanumeric ASCII characters. <i>Default:</i> "user"
getvar	This command instructs the printer to respond with the LEAP user name. <i>Format:</i> ! U1 getvar "wlan.leap_username"



Example • This `setvar` example shows the value set to "user".

```
! U1 setvar "wlan.leap_username" "user"
```

When the `setvar` value is set to "user", the `getvar` result is "user".



Note •

- For printer support, see [SGD Command Support on page 1267](#).
- For details on SGD command structure, see [Command Structure on page 635](#).

wlan.mac_addr

Description This command retrieves the MAC address of the wireless print server.

Type `getvar`

Commands	Details
<code>getvar</code>	This command instructs the printer to respond with the MAC address of the wireless print server. <i>Format:</i> <code>! U1 getvar "wlan.mac_addr"</code>



Example • In this example, the `getvar` result is the MAC address for the wireless print server.

```
! U1 getvar "wlan.mac_addr"
```



Note •

- For printer support, see [SGD Command Support on page 1267](#).
- For details on SGD command structure, see [Command Structure on page 635](#).

wlan.mac_raw

Description This command specifies the RAW MAC address of the wireless print server. The raw mac address is the mac address without the colons (":").

Type `getvar`

Commands	Details
<code>getvar</code>	This command retrieves the RAW MAC address of the wireless print server. <i>Format:</i> <code>! U1 getvar "wlan.mac_raw"</code>



Example • In this example, the `getvar` retrieves the RAW MAC address of the wireless print server.

```
! U1 getvar "wlan.mac_raw"
```



Note •

- For printer support, see [SGD Command Support on page 1267](#).
- For details on SGD command structure, see [Command Structure on page 635](#).

wlan.operating_mode

Description This printer setting refers to the network operating mode. Infrastructure mode means that the printer will try to associate with an access point. Ad hoc mode means that the printer will try to associate with a device other than an access point and join a standalone network.

To use "ad hoc" mode configure the printer as follows:

- Set the ESSID to the new network's ESSID.
- Turn off the DHCP and assign an IP Address to the printer.
- Set the subnet mask on the printer to the new network's subnet mask.
- Change the operating mode on the printer to "ad hoc".

Type setvar;getvar

Commands	Details
setvar	This command instructs the printer to set the network operating mode. <i>Format:</i> ! U1 setvar "wlan.operating_mode" "value" <i>Values:</i> "adhoc" = printer will try to associate with a network device "infrastructure" = printer will try to associate with an access point <i>Default:</i> "infrastructure"
getvar	This command instructs the printer to respond with the network-mode value. <i>Format:</i> ! U1 getvar "wlan.operating_mode"



Example • This setvar example shows the value set to "infrastructure".

```
! U1 setvar "wlan.operating_mode" "infrastructure"
```

When the setvar value is set to "infrastructure", the getvar result is "infrastructure".



Note •

- For printer support, see [SGD Command Support on page 1267](#).
- For details on SGD command structure, see [Command Structure on page 635](#).

wlan.password

Description This printer setting refers to the generic password that is used by the wireless securities that need a password.



Important • Kerberos has its own password field

Type setvar;getvar

Commands	Details
setvar	This command instructs the printer to set a generic password for the wireless securities that need a password. <i>Format:</i> ! U1 setvar "wlan.password" "value" <i>Values:</i> A maximum of 32 alphanumeric characters. <i>Default:</i> "password"
getvar	This command instructs the printer to respond with a generic password for wireless securities. <i>Format:</i> ! U1 getvar "wlan.password" For protection a single "*" prints.



Example • This setvar example shows the value set to "password".

```
! U1 setvar "wlan.password" "password"
```

When the setvar value is set to "password", the getvar result is "*".



Note •

- For printer support, see [SGD Command Support on page 1267](#).
- For details on SGD command structure, see [Command Structure on page 635](#).

wlan.permitted_channels

Description This command returns the list of permitted channels.

Related Commands:

- [wlan.active_channels](#) on page 1099
- [wlan.allowed_band](#) on page 1100

Supported Devices ZT200 Series

Type getvar

Commands	Details
getvar	<p>This command returns the list of permitted channels within the defined country or region.</p> <p><i>Format:</i> ! U1 getvar "wlan.permitted_channels"</p> <p><i>Result:</i> One or more of the following channels: 1, 2, 3, 4, 5, 6, 7, 8, 9, 10, 11, 36, 40, 44, 48, 52, 56, 60, 64, 100, 104, 108, 112, 116, 132, 136, 140</p>



Note •

- For printer support, see [SGD Command Support](#) on page 1267.
- For details on SGD command structure, see [Command Structure](#) on page 635.

wlan.preamble

Description This printer setting selects the radio preamble length to be used.

Type setvar;getvar

Commands	Details
setvar	This command instructs the printer to set the preamble length. <i>Format:</i> ! U1 setvar "wlan.preamble" "value" <i>Values:</i> "long" = enables long preamble "short" = enables short preamble <i>Default:</i> "long"
getvar	This command instructs the printer to respond with the current preamble length. <i>Format:</i> ! U1 getvar "wlan.preamble"



Example • This setvar example shows the value set to "long".

```
! U1 setvar "wlan.preamble" "long"
```

When the setvar value is set to "long", the getvar result is "long".



Note •

- For printer support, see [SGD Command Support on page 1267](#).
- For details on SGD command structure, see [Command Structure on page 635](#).

wlan.private_key_password

Description This printer setting allows the setting of the optional private key password.

Type setvar;getvar

Commands	Details
setvar	This command instructs the printer to set the private key password. <i>Format:</i> ! U1 setvar "wlan.private_key_password" "value" <i>Values:</i> A maximum of 32 alphanumeric characters <i>Default:</i> ""
getvar	This command instructs the printer to respond with the value of the private key password. <i>Format:</i> ! U1 getvar "wlan.private_key_password" For protection a single "*" prints.



Example • This `setvar` example shows the value set to "password".

```
! U1 setvar "wlan.private_key_password" "password"
```

When the `setvar` value is set to "password", the `getvar` result is "*".



Note •

- For printer support, see [SGD Command Support on page 1267](#).
- For details on SGD command structure, see [Command Structure on page 635](#).

wlan.region_code

Description This command defines the regulatory country for which the radio is currently configured.

Supported Devices

Type setvar;getvar

Commands	Details
setvar	This command sets the region code for which the radio is to be configured. ! U1 setvar "wlan.region_code" "value" <i>Values:</i> <ul style="list-style-type: none">• not available• usa/canada• japan• rest of world
getvar	This command retrieves the region code for which the radio is currently configured. ! U1 getvar "wlan.country_code"



Note •

- For printer support, see [SGD Command Support on page 1267](#).
- For details on SGD command structure, see [Command Structure on page 635](#).

wlan.roam.interchannel_delay

Description This command sets how long of a delay before scanning the next channel when roaming.

Type setvar;getvar

Commands	Details
setvar	<p>This command sets how long of a delay before scanning the next channel when roaming. The values are in milliseconds.</p> <p><i>Format:</i> ! U1 setvar "wlan.roam.interchannel_delay" "value"</p> <p><i>Values:</i> 0 to 30000</p> <p><i>Default:</i> "400"</p>
getvar	<p>This command retrieves the current set delay time before scanning the next channel when roaming.</p> <p><i>Format:</i> ! U1 getvar "wlan.roam.interchannel_delay"</p>



Example • This `setvar` example shows the value set to "400".

```
! U1 setvar "wlan.roam.interchannel_delay" "400"
```

The `getvar` result returns the current `setvar` value. In this example, the `getvar` result is "400".



Note •

- For printer support, see [SGD Command Support on page 1267](#).
- For details on SGD command structure, see [Command Structure on page 635](#).

wlan.roam.interval

Description This printer setting refers to specifying the wireless roam interval.

Type setvar;getvar

Commands	Details
setvar	This command instructs the printer to set the wireless roam interval. <i>Format:</i> ! U1 setvar "wlan.roam.interval" "value" <i>Values:</i> Decimal values between 5 and 255 inclusive <i>Default:</i> "20"
getvar	This command instructs the printer to respond with the specified roam interval. <i>Format:</i> ! U1 getvar "wlan.roam.interval"



Example • This `setvar` example shows the value set to "20".

```
! U1 setvar "wlan.roam.interval" "20"
```

When the `setvar` value is set to "20", the `getvar` result is "20".



Note •

- For printer support, see [SGD Command Support on page 1267](#).
- For details on SGD command structure, see [Command Structure on page 635](#).

wlan.roam.max_chan_scan_time

Description This command sets how long the radio waits on a channel looking for probe responses.

Type setvar;getvar

Commands	Details
setvar	<p>This command sets how long the radio waits on a channel looking for probe responses. The values are in milliseconds.</p> <p><i>Format:</i> ! U1 setvar "wlan.roam.max_chan_scan_time" "value"</p> <p><i>Values:</i> 10 to 500</p> <p><i>Default:</i> "100"</p>
getvar	<p>This command retrieves the current setting for how long the radio waits on a channel looking for probe responses.</p> <p><i>Format:</i> ! U1 getvar "wlan.roam.max_chan_scan_time"</p>



Example • This `setvar` example shows the value set to "100".

```
! U1 setvar "wlan.roam.max_chan_scan_time" "100"
```

The `getvar` result returns the current `setvar` value. In this example, the `getvar` result is "100".



Note •

- For printer support, see [SGD Command Support on page 1267](#).
- For details on SGD command structure, see [Command Structure on page 635](#).

wlan.roam.max_fail

Description This command determines the number of consecutive tx packet failures, at which point the radio should start its roaming algorithm.

Type setvar;getvar

Commands	Details
setvar	This command sets the max_fail threshold value. <i>Format:</i> ! U1 setvar "wlan.roam.max_fail" "value" <i>Values:</i> 2 to 75 inclusive <i>Default Value:</i> 10
getvar	This command returns the number for the max_fail threshold. <i>Format:</i> ! U1 getvar "wlan.roam.max_fail"



Example • In this example, the setvar sets the max_fail threshold value to 30 packets.

```
! U1 setvar "wlan.roam.max_fail" "30"
```



Note •

- For printer support, see [SGD Command Support on page 1267](#).
- For details on SGD command structure, see [Command Structure on page 635](#).

wlan.roam.rssi

Description This command allows you to specify the absolute value of the negative dBm for the RSSI threshold, which is the point at which the radio will start the roaming algorithm.

Type setvar;getvar

Commands	Details
setvar	This command sets the RSSI threshold value. <i>Format:</i> ! U1 setvar "wlan.roam.rssi" "value" <i>Values:</i> 60 to 125 <i>Default Value:</i> 74
getvar	This command retrieves the absolute value of the negative dBm for the RSSI threshold. <i>Format:</i> ! U1 getvar "wlan.roam.rssi"



Example • In this example, the `setvar` sets the RSSI threshold value to -80 dBm.

```
! U1 setvar "wlan.roam.rssi" "80"
```



Note •

- For printer support, see [SGD Command Support on page 1267](#).
- For details on SGD command structure, see [Command Structure on page 635](#).

wlan.roam.signal

Description This printer setting refers to specifying the wireless roam signal.

Type setvar;getvar

Commands	Details
setvar	This command instructs the printer to set the wireless roam signal. <i>Format:</i> ! U1 setvar "wlan.roam.signal" "value" <i>Values:</i> Decimal values between 1 and 75 inclusive. <i>Default:</i> "50"
getvar	This command instructs the printer to respond with the specified wireless roam signal. <i>Format:</i> ! U1 getvar "wlan.roam.signal"



Example • This `setvar` example shows the value set to "50".

```
! U1 setvar "wlan.roam.signal" "50"
```

When the `setvar` value is set to "50", the `getvar` result is "50".



Note •

- For printer support, see [SGD Command Support on page 1267](#).
- For details on SGD command structure, see [Command Structure on page 635](#).

wlan.security

Description This printer setting allows you to specify both the wireless encryption type and authentication type in one command.



Note • The supporting parameters that are required vary based on the security type that you select. See [Supporting SGD Commands for Different Security Types](#) on page 1168 for instructions for each security type.

When using certificate files, Zebra printers support:

- using Privacy Enhanced Mail (PEM) formatted certificate files.
- using the client certificate and private key as two files, each downloaded separately.
- using exportable PAC files for EAP-FAST.

These certificate files can only be sent using ZPL, not SGD. The ZPL command to use when sending these certificate files is the `~DY` command.

Configuring the printer for WPA also allows the printer to be used in WPA2 environments.



Important • When using certificate files, the time on the printer must be set correctly for the websocket connection to succeed, as the time is used in the certificate validation.

Type `setvar;getvar`

Commands	Details
<code>setvar</code>	<p>This command instructs the printer to set the wireless security value.</p> <p><i>Format:</i> <code>! U1 setvar "wlan.security" "value"</code></p> <p><i>Values:</i></p> <ul style="list-style-type: none"> "1" = No wireless security or "none" "2" = WEP 40-bit or "wep 40-bit" "3" = WEP 128-bit or "wep 128-bit" "4" = EAP-TLS or "eap-tls" "5" = EAP-TTLS or "eap-ttls" "6" = EAP-FAST or "eap-fast" "7" = PEAP or "peap" "8" = LEAP or "leap" "9" = WPA PSK or "wpa psk" (Key rotation for WPA2 PSK is supported in firmware versions V53.15.8Z , V60.15.8Z, and later.) "10" = WPA EAP-TLS or "wpa eap-tls" "11" = WPA EAP-TTLS or "wpa eap-ttls" "12" = WPA EAP-FAST or "wpa eap-fast" "13" = WPA PEAP or "wpa peap" "14" = WPA LEAP or "wpa leap" "15" = Kerberos or "kerberos" <p><i>Default:</i> "1"</p>

Commands	Details
getvar	This command instructs the printer to return the name and not the type. If an invalid security mode is entered the printer returns Invalid Mode. <i>Format: ! U1 getvar "wlan.security" "value"</i>



Example • This `setvar` example shows the value set to "1".

```
! U1 setvar "wlan.security" "1"
```

When the `setvar` value is set to "1", the `getvar` result is "none".



Note •

- For printer support, see [SGD Command Support on page 1267](#).
- For details on SGD command structure, see [Command Structure on page 635](#).

Supporting SGD Commands for Different Security Types

The supporting SGD commands required for `wlan.security` vary based on the security type that you select. You must send the additional commands for your printer to be able to work on your wireless network. Follow the example and format for your specific security type in this section, substituting your own wireless network data.

Security Type 1: No Wireless Security Active

Additional parameters that need to be set: none



Example • This example turns off all wireless securities controlled under this command, but it does not reset the printer's wireless settings to their defaults.

```
! U1 setvar "wlan.security" "1"
```

Security Type 2: WEP 40-Bit

Additional parameters that need to be set and the SGD commands to use:

- WEP encryption index (see [wlan.wep.index on page 1185](#))
- WEP authentication type (see [wlan.wep.auth_type on page 1184](#))
- WEP key type (see [wlan.wep.key_format on page 1191](#))
- the actual values of any WEP encryption keys to be used (see [wlan.wep.key1 on page 1186](#), [wlan.wep.key2 on page 1187](#), [wlan.wep.key3 on page 1188](#), or [wlan.wep.key4 on page 1189](#))

→ **Example** • This example configures the printer for WEP 40-bit encryption using index key 1, open authentication, and a hexadecimal WEP key with a value of “A1B2C3D4F5.”

```
! U1 setvar "wlan.security" "2"  
! U1 setvar "wlan.wep.index" "1"  
! U1 setvar "wlan.wep.auth_type" "open"  
! U1 setvar "wlan.wep.key_format" "hex"  
! U1 setvar "wlan.wep.key1" "A1B2C3D4F5"
```

Security Type 3: WEP 128-Bit

Additional parameters that need to be set and the SGD commands to use:

- WEP encryption index (see [wlan.wep.index](#) on page 1185)
- WEP authentication type (see [wlan.wep.auth_type](#) on page 1184)
- WEP key type (see [wlan.wep.key_format](#) on page 1191)
- the actual values of any WEP encryption keys to be used (see [wlan.wep.key1](#) on page 1186, [wlan.wep.key2](#) on page 1187, [wlan.wep.key3](#) on page 1188, or [wlan.wep.key4](#) on page 1189)

→ **Example** • This example configures the printer for WEP 128-bit encryption using index key 2, open authentication, and four hexadecimal WEP keys.

```
! U1 setvar "wlan.security" "3"  
! U1 setvar "wlan.wep.index" "2"  
! U1 setvar "wlan.wep.auth_type" "open"  
! U1 setvar "wlan.wep.key_format" "hex"  
! U1 setvar "wlan.wep.key1" "001122334455667788"  
! U1 setvar "wlan.wep.key2" "112233445566778899"  
! U1 setvar "wlan.wep.key3" "223344556677889900"  
! U1 setvar "wlan.wep.key4" "334455667788990011"
```

Security Type 4: EAP-TLS

Additional parameters that need to be set and the SGD commands to use:

- optional private key password (see [wlan.private_key_password](#) on page 1159)

→ **Example** • This example configures the printer for EAP-TLS authentication with an optional private key password with a value of “private.”

```
! U1 setvar "wlan.security" "4"  
! U1 setvar "wlan.private_key_password" "private"
```

Security Type 5: EAP-TTLS

Additional parameters that need to be set and the SGD commands to use:

- user ID (see [wlan.username](#) on page 1181)
- password (see [wlan.password](#) on page 1156)



Example • This example configures the printer for EAP-TTLS authentication, including a user ID with a value of “**user**” and a password with a value of “**password**.”

```
! U1 setvar "wlan.security" "5"  
! U1 setvar "wlan.username" "user"  
! U1 setvar "wlan.password" "password"
```

Security Type 6: EAP-FAST

Additional parameters that need to be set and the SGD commands to use:

- user ID (see [wlan.username](#) on page 1181)
- password (see [wlan.password](#) on page 1156)
- optional private key password (see [wlan.private_key_password](#) on page 1159)



Example • This example configures the printer for EAP-FAST authentication, including a user ID of “**user**,” a password of “**password**,” and an optional private key of “**private**.”

```
! U1 setvar "wlan.security" "6"  
! U1 setvar "wlan.username" "user"  
! U1 setvar "wlan.password" "password"  
! U1 setvar "wlan.private_key_password" "private"
```

Security Type 7: PEAP

Additional parameters that need to be set and the SGD commands to use:

- user ID (see [wlan.username](#) on page 1181)
- password (see [wlan.password](#) on page 1156)



Example • This example configures the printer for PEAP authentication, including a user ID with a value of “**user**” and a password with a value of “**password**.”

```
! U1 setvar "wlan.security" "7"  
! U1 setvar "wlan.username" "user"  
! U1 setvar "wlan.password" "password"
```

Security Type 8: LEAP

Additional parameters that need to be set and the SGD commands to use:

- user ID (see [wlan.username](#) on page 1181)
- password (see [wlan.password](#) on page 1156)



Example • This example configures the printer for LEAP authentication, including a user ID with a value of “`user`” and a password with a value of “`password`.”

```
! U1 setvar "wlan.security" "8"  
! U1 setvar "wlan.username" "user"  
! U1 setvar "wlan.password" "password"
```

Security Type 9: WPA PSK



Note • Configuring the printer for WPA also allows the printer to be used in WPA2 environments. Key rotation for WPA2 PSK is supported in firmware version 60.15.8Z and later and in firmware version 53.15.8Z and later.

Additional parameters that need to be set and the SGD commands to use:

- Pre-Shared Key (PSK) value (see [wlan.wpa.psk](#) on page 1190)



Example • This example configures the printer for WPA PSK authentication with a PSK value of all zeroes (64 hexadecimal digits).

```
! U1 setvar "wlan.security" "9"  
! U1 setvar "wlan.wpa.psk" "00000000..."
```

Security Type 10: WPA EAP-TLS



Note • Configuring the printer for WPA also allows the printer to be used in WPA2 environments.

Additional parameters that need to be set and the SGD commands to use:

- optional private key password (see [wlan.private_key_password](#) on page 1159)



Example • This example configures the printer for WPA EAP-TLS authentication with an optional private key password with a value of “`private`.”

```
! U1 setvar "wlan.security" "10"  
! U1 setvar "wlan.private_key_password" "private"
```

Security Type 11: WPA EAP-TTLS



Note • Configuring the printer for WPA also allows the printer to be used in WPA2 environments.

Additional parameters that need to be set and the SGD commands to use:

- user ID (see [wlan.username](#) on page 1181)
- password (see [wlan.password](#) on page 1156)



Example • This example configures the printer for WPA EAP-TTLS authentication, including a user ID with a value of “user” and a password with a value of “password.”

```
! U1 setvar "wlan.security" "11"  
! U1 setvar "wlan.username" "user"  
! U1 setvar "wlan.password" "password"
```

Security Type 12: WPA EAP-FAST



Note • Configuring the printer for WPA also allows the printer to be used in WPA2 environments.

Additional parameters that need to be set and the SGD commands to use:

- user ID (see [wlan.username](#) on page 1181)
- password (see [wlan.password](#) on page 1156)
- optional private key password (see [wlan.private_key_password](#) on page 1159)



Example • This example configures the printer for WPA EAP-FAST authentication, including a user ID of “user,” a password of “password,” and an optional private key of “private.”

```
! U1 setvar "wlan.security" "12"  
! U1 setvar "wlan.username" "user"  
! U1 setvar "wlan.password" "password"  
! U1 setvar "wlan.private_key_password" "private"
```

Security Type 13: WPA PEAP



Note • Configuring the printer for WPA also allows the printer to be used in WPA2 environments.

Additional parameters that need to be set and the SGD commands to use:

- user ID (see [wlan.username](#) on page 1181)

- password (see [wlan.password](#) on page 1156)



Example • This example configures the printer for WPA PEAP authentication, including a user ID with a value of “user” and a password with a value of “password.”

```
! U1 setvar "wlan.security" "13"  
! U1 setvar "wlan.username" "user"  
! U1 setvar "wlan.password" "password"
```

Security Type 14: WPA LEAP



Note • Configuring the printer for WPA also allows the printer to be used in WPA2 environments.

Additional parameters that need to be set and the SGD commands to use:

- user ID (see [wlan.username](#) on page 1181)
- password (see [wlan.password](#) on page 1156)



Example • This example configures the printer for WPA LEAP authentication, including a user ID with a value of “user” and a password with a value of “password.”

```
! U1 setvar "wlan.security" "14"  
! U1 setvar "wlan.username" "user"  
! U1 setvar "wlan.password" "password"
```

Security Type 15: Kerberos

Additional parameters that need to be set and the SGD commands to use:

- Kerberos user ID (see [wlan.kerberos.username](#) on page 1149)
- Kerberos password (see [wlan.kerberos.password](#) on page 1147)
- realm (see [wlan.kerberos.realm](#) on page 1148)
- Key Distribution Center (KDC) (see [wlan.kerberos.kdc](#) on page 1145)



Example • This example configures the printer for Kerberos encryption, including a Kerberos user ID with a value of “user,” a Kerberos password with a value of “password,” a realm of “zebra,” and a KDC of “krbtgt.”

```
! U1 setvar "wlan.security" "15"  
! U1 setvar "wlan.kerberos.username" "user"  
! U1 setvar "wlan.kerberos.password" "password"  
! U1 setvar "wlan.kerberos.realm" "zebra"  
! U1 setvar "wlan.kerberos.kdc" "krbtgt"
```

wlan.signal_noise

Description This command returns the signal noise on the wireless network. Values above 40% represent a very significant noise, and radio communication is not reliable.

Type `getvar`

Commands	Details
<code>getvar</code>	This command instructs the printer to return the current signal noise on the wireless network. <i>Format:</i> <code>! U1 getvar "wlan.signal_noise"</code>



Example • In this example, the `getvar` result is the current `signal_noise` value.

```
! U1 getvar "wlan.signal_noise"
```



Note •

- For printer support, see [SGD Command Support on page 1267](#).
- For details on SGD command structure, see [Command Structure on page 635](#).

wlan.signal_quality

Description This command instructs the printer to return the current signal quality of the wireless network. Values below 40% represent a very poor signal quality, and radio communication is not reliable.

Type `getvar`

Commands	Details
<code>getvar</code>	This command instructs the printer to return the current signal quality of the wireless network. <i>Format:</i> <code>! U1 getvar "wlan.signal_quality"</code>



Example • In this example, the `getvar` result is the current `signal_quality` value.

```
! U1 getvar "wlan.signal_quality"
```



Note •

- For printer support, see [SGD Command Support on page 1267](#).
- For details on SGD command structure, see [Command Structure on page 635](#).

wlan.signal_strength

Description This command returns the signal strength of the connection to the access point as a percentage value between zero (not connected) and 100 (strongest signal). Values below 40% represent a very poor signal and radio communication is not reliable.

Type `getvar`

Commands	Details
<code>getvar</code>	This command instructs the printer to respond with the current signal strength. <i>Format:</i> <code>! U1 getvar "wlan.signal_strength"</code>



Example • In this example, the `getvar` result is "93".

```
! U1 getvar "wlan.signal_strength"
```



Note •

- For printer support, see [SGD Command Support on page 1267](#).
- For details on SGD command structure, see [Command Structure on page 635](#).

wlan.station_name

Description This printer setting refers to the station name.

Type setvar;setvar

Commands	Details
setvar	This command instructs the printer to set the station name. <i>Format:</i> ! U1 setvar "wlan.station_name" "value" <i>Values:</i> A maximum of 32 alphanumeric characters <i>Default:</i> "ZEBRA"
getvar	This command instructs the printer to respond with the station name value. <i>Format:</i> ! U1 getvar "wlan.station_name"



Example • This `setvar` example shows the value set to "ZEBRA".

```
! U1 setvar "wlan.station_name" "ZEBRA"
```

When the `setvar` value is set to "ZEBRA", the `getvar` result is "ZEBRA".



Note •

- For printer support, see [SGD Command Support on page 1267](#).
- For details on SGD command structure, see [Command Structure on page 635](#).

wlan.tx_power

Description This printer setting refers to specifying the wireless transmit power.

Type setvar;getvar

Commands	Details
setvar	This command instructs the printer to set the wireless transmit power. <i>Format:</i> ! U1 setvar "wlan.tx_power" "value" <i>Values:</i> Decimal values of 1, 5, 20, 30, 50, 100 <i>Default:</i> "100"
getvar	This command instructs the printer to respond with the wireless transmit power. <i>Format:</i> ! U1 getvar "wlan.tx_power"



Example • This `setvar` example shows the value set to "100".

```
! U1 setvar "wlan.tx_power" "100"
```

When the `setvar` value is set to "100", the `getvar` result is "100".



Note •

- For printer support, see [SGD Command Support on page 1267](#).
- For details on SGD command structure, see [Command Structure on page 635](#).

wlan.tx_rate

Description This printer setting refers to specifying the wireless transmit rate.

Type setvar;getvar

Commands	Details
setvar	This command instructs the printer to set the wireless transmit rate. <i>Format:</i> ! U1 setvar "wlan.tx_rate" "value" <i>Values:</i> 1, 2, 5.5, 11, all <i>Default:</i> "all"
getvar	This command instructs the printer to respond with the wireless transmit rate. <i>Format:</i> ! U1 getvar "wlan.tx_rate"



Example • This `setvar` example shows the value set to "all".

```
! U1 setvar "wlan.tx_rate" "all"
```

When the `setvar` value is set to "all", the `getvar` result is "all".



Note •

- For printer support, see [SGD Command Support on page 1267](#).
- For details on SGD command structure, see [Command Structure on page 635](#).

wlan.user_channel_list

Description This command sets the list of available channels.

Related Commands:

- [wlan.active_channels](#) on page 1099
- [wlan.allowed_band](#) on page 1100
- [wlan.permitted_channels](#) on page 1157

Supported Devices ZT200 Series

Type setvar;getvar

Commands	Details
setvar	<p>This command sets the list of available channels.</p> <p><i>Format:</i> ! U1 setvar "wlan.user_channel_list" "value"</p> <p><i>Values:</i> One or more of the following: 1,2,3,4,5,6,7,8,9,10,11,36,40,44,48,52,56,60,64,100,104,108,112,116,132,136,140,149,153,157,161,165,all</p> <p><i>Default:</i> "all"</p>
getvar	<p>This command retrieves the currently set list of available channels.</p> <p><i>Format:</i> ! U1 getvar wlan.user_channel_list"</p>



Example • This example sets the available channel list to channels 1-9.

```
! U1 setvar "wlan.user_channel_list" "1,2,3,4,5,6,7,8,9"
```



Note •

- For printer support, see [SGD Command Support](#) on page 1267.
- For details on SGD command structure, see [Command Structure](#) on page 635.

wlan.username

Description This printer setting refers to the generic user name that is used by the wireless securities that need a user name.



Important • Kerberos has its own user name field.

Type `setvar;getvar`

Commands	Details
<code>setvar</code>	<p>This command instructs the printer to set a generic user name for wireless securities that need a user name.</p> <p><i>Format:</i> <code>! U1 setvar "wlan.username" "value"</code></p> <p><i>Values:</i> A maximum of 32 alphanumeric characters</p> <p><i>Default:</i> <code>"user"</code></p>
<code>getvar</code>	<p>This command instructs the printer to respond with a generic user name for the wireless securities that need a user name.</p> <p><i>Format:</i> <code>! U1 getvar "wlan.username"</code></p>



Example • This `setvar` example shows the value set to `"user"`.

```
! U1 setvar "wlan.username" "user"
```

When the `setvar` value is set to `"user"`, the `getvar` result is `"user"`.



Note •

- For printer support, see [SGD Command Support on page 1267](#).
- For details on SGD command structure, see [Command Structure on page 635](#).

wlan.waveagent.enable

Description This command enables/disables the internal agent for support of Veriwave's WaveDeploy system. WaveDeploy is a software product used for performing network site surveys.

Supported Devices ZT200 Series

Type setvar;getvar

Commands	Details
setvar	This command enables or disables internal agent support for waveagent. <i>Format:</i> ! U1 setvar "wlan.waveagent.enable" "value" <i>Values:</i> "off" "on" <i>Default:</i> "off"
getvar	This command instructs the printer to respond with the current waveagent support status. <i>Format:</i> ! U1 getvar "wlan.waveagent.enable"



Example •

```
! U1 setvar "wlan.waveagent.enable" "on"
```



Note •

- For printer support, see [SGD Command Support on page 1267](#).
- For details on SGD command structure, see [Command Structure on page 635](#).

wlan.waveagent.udp_port

Description This command specifies the UDP port number used by WaveAgent.

Supported Devices ZT200 Series

Type setvar;setvar

Commands	Details
setvar	This command specifies the port to be used by WaveAgent. <i>Format:</i> ! U1 setvar "wlan.waveagent.udp_port" "value" <i>Values:</i> "1" to "64000" <i>Default:</i> "18100"
getvar	This command instructs the printer to respond with the current port setting for WaveAgent. <i>Format:</i> ! U1 getvar "wlan.waveagent.udp_port"



Example • This `setvar` example shows the value set to "on".

```
! U1 setvar "wlan.waveagent.udp_port" "21000"
```



Note •

- For printer support, see [SGD Command Support on page 1267](#).
- For details on SGD command structure, see [Command Structure on page 635](#).

wlan.wep.auth_type

Description For the WEP security type, this printer setting selects the authentication type to be used between the printer and the access point. The authentication types are open system and shared key.

Type setvar;setvar

Commands	Details
setvar	This command instructs the printer to set the WEP authentication type. <i>Format:</i> ! U1 setvar "wlan.wep.auth_type" "value" <i>Values:</i> "open" = enables the open authentication type "shared" = enables the shared authentication type <i>Default:</i> "open"
getvar	This command instructs the printer to retrieve the current WEP authentication type. <i>Format:</i> ! U1 getvar "wlan.wep.auth_type"



Example • This setvar example shows the value set to "open".

```
! U1 setvar "wlan.wep.auth_type" "open"
```

When the setvar value is set to "open", the getvar result is "open".



Note •

- For printer support, see [SGD Command Support on page 1267](#).
- For details on SGD command structure, see [Command Structure on page 635](#).

wlan.wep.index

Description This printer setting refers to the WEP (Wired Equivalent Privacy) encryption key index. This printer setting determines which one of the four encryption keys is to be used by the client (printer).

Type setvar;setvar

Commands	Details
setvar	<p>This command instructs the printer to set the encryption key index.</p> <p><i>Format:</i> ! U1 setvar "wlan.wep.index" "value"</p> <p><i>Values:</i></p> <ul style="list-style-type: none"> "1" = enables encryption key 1 "2" = enables encryption key 2 "3" = enables encryption key 3 "4" = enables encryption key 4 <p><i>Default:</i> "1"</p>
getvar	<p>This command instructs the printer to respond with the encryption key index.</p> <p><i>Format:</i> ! U1 getvar "wlan.wep.index"</p>



Example • This `setvar` example shows the value set to "1".

```
! U1 setvar "wlan.wep.index" "1"
```

When the `setvar` value is set to "1", the `getvar` result is "1".



Note •

- For printer support, see [SGD Command Support on page 1267](#).
- For details on SGD command structure, see [Command Structure on page 635](#).

wlan.wep.key1

Description This printer setting refers to the first indexed WEP encryption key. The WEP encryption key is a hexadecimal or string value. This key should match the wireless network WEP encryption key 1.

Type setvar;setvar

Commands	Details
setvar	This command instructs the printer to set the encryption key. <i>Format:</i> ! U1 setvar "wlan.wep.key1" "value" <i>Values:</i> 10 hexadecimal characters for 40-bit encryption 26 hexadecimal characters for 128-bit encryption <i>Default:</i> All zeros
getvar	This command instructs the printer to respond with the encryption key. <i>Format:</i> ! U1 getvar "wlan.wep.key1" For protection a single "*" prints.



Example • This `setvar` example shows the value set to "A1B2C3D4F5".

```
! U1 setvar "wlan.wep.key1" "A1B2C3D4F5"
```

When the `setvar` value is set to "A1B2C3D4F5", the `getvar` result is "*".



Note •

- For printer support, see [SGD Command Support on page 1267](#).
- For details on SGD command structure, see [Command Structure on page 635](#).

wlan.wep.key2

Description This printer setting refers to the second indexed WEP encryption key. The WEP encryption key is a hexadecimal string value. This key should match the wireless network WEP encryption key 2.

Type setvar;getvar

Commands	Details
setvar	<p>This command instructs the printer to set the encryption key.</p> <p><i>Format:</i> ! U1 setvar "wlan.wep.key2" "value"</p> <p><i>Values:</i></p> <ul style="list-style-type: none"> 10 hexadecimal characters for 40-bit encryption 26 hexadecimal characters for 128-bit encryption <p><i>Default:</i> All zeros</p>
getvar	<p>This command instructs the printer respond with the encryption key.</p> <p><i>Format:</i> ! U1 getvar "wlan.wep.key2"</p> <p>For protection a single "*" prints.</p>



Example • This setvar example shows the value set to "A1B2C3D4F5".

```
! U1 setvar "wlan.wep.key2" "A1B2C3D4F5"
```

When the setvar value is set to "A1B2C3D4F5", the getvar result is "*".



Note •

- For printer support, see [SGD Command Support on page 1267](#).
- For details on SGD command structure, see [Command Structure on page 635](#).

wlan.wep.key3

Description This printer setting refers to the third indexed WEP encryption key. The WEP encryption key is a hexadecimal string value. This key should match the wireless network WEP encryption key 3.

Type setvar;setvar

Commands	Details
setvar	This command instructs the printer to set the encryption key. <i>Format:</i> ! U1 setvar "wlan.wep.key3" "value" <i>Values:</i> 10 hexadecimal characters for 40-bit encryption 26 hexadecimal characters for 128-bit encryption <i>Default:</i> All zeros
getvar	This command instructs the printer to respond with the encryption key. <i>Format:</i> ! U1 getvar "wlan.wep.key3" For protection a single "*" prints.



Example • This `setvar` example shows the value set to "A1B2C3D4F5".

```
! U1 setvar "wlan.wep.key3" "A1B2C3D4F5"
```

When the `setvar` value is set to "A1B2C3D4F5", the `getvar` result is "*".



Note •

- For printer support, see [SGD Command Support on page 1267](#).
- For details on SGD command structure, see [Command Structure on page 635](#).

wlan.wep.key4

Description This printer setting refers to the fourth indexed WEP encryption key. The WEP encryption key is a hexadecimal string value. This key should match the wireless network WEP encryption key 4.

Type setvar;setvar

Commands	Details
setvar	<p>This command instructs the printer to set the encryption key.</p> <p><i>Format:</i> ! U1 setvar "wlan.wep.key4" "value"</p> <p><i>Values:</i></p> <ul style="list-style-type: none"> 10 hexadecimal characters for 40-bit encryption 26 hexadecimal characters for 128-bit encryption <p><i>Default:</i> All zeros</p>
getvar	<p>This command instructs the printer respond with the encryption key.</p> <p><i>Format:</i> ! U1 getvar "wlan.wep.key4"</p> <p>For protection a single "*" prints.</p>



Example • This `setvar` example shows the value set to "A1B2C3D4F5".

```
! U1 setvar "wlan.wep.key4" "A1B2C3D4F5"
```

When the `setvar` value is set to "A1B2C3D4F5", the `getvar` result is "*".



Note •

- For printer support, see [SGD Command Support on page 1267](#).
- For details on SGD command structure, see [Command Structure on page 635](#).

wlan.wpa.psk

Description This printer setting specifies the pre-shared key (PSK) value to use when the WPA authentication is set to PSK.

Type setvar;setvar

Commands	Details
setvar	This command instructs the printer to set the pre-shared key. <i>Format:</i> ! U1 setvar "wlan.wpa.psk" "value" <i>Values:</i> 64 hexadecimal digits <i>Default:</i> 64 zeros (00000000...)
getvar	This command instructs the printer to respond with the pre-shared key. <i>Format:</i> ! U1 getvar "wlan.wpa.psk" For protection a single "*" prints.



Example • This `setvar` example shows the value set to "00000000...".

```
! U1 setvar "wlan.wpa.psk" "00000000..."
```

When the `setvar` value is set to "00000000...", the `getvar` result is "*".



Note •

- For printer support, see [SGD Command Support on page 1267](#).
- For details on SGD command structure, see [Command Structure on page 635](#).

wlan.wep.key_format

Description This printer setting specifies the format for the WEP key.



Important • This printer setting should proceed any of the `wep.key` settings if you select a non-default value.

Type `setvar;getvar`

Commands	Details
<code>setvar</code>	<p>This command instructs the printer to set the WEP key format.</p> <p><i>Format:</i> <code>! U1 setvar "wlan.wep.key_format" "value"</code></p> <p><i>Values:</i></p> <ul style="list-style-type: none"> <code>"ascii"</code> = WEP key is set by ASCII string <code>"hex"</code> = WEP key is a Hex string <p><i>Default:</i> <code>"hex"</code></p>
<code>getvar</code>	<p>This command instructs the printer to respond with the WEP key format.</p> <p><i>Format:</i> <code>! U1 getvar "wep.key_format"</code></p>



Example • This `setvar` example shows the value set to `"ascii"`.

```
! U1 setvar "wlan.wep.key_format" "ascii"
```

When the `setvar` value is set to `"ascii"`, the `getvar` result is `"ascii"`.



Note •

- For printer support, see [SGD Command Support on page 1267](#).
- For details on SGD command structure, see [Command Structure on page 635](#).

Zebra Code Pages

This section provides you with a visual of the different Zebra Code pages.

Zebra Code Page 850 — Latin Character Set

This is the Zebra Code Page 850:



Note • For hex 5C, a cent sign prints for all printer resident fonts. A backslash prints for downloaded fonts.

CHR	HEX	DEC	CHR	HEX	DEC	CHR	HEX	DEC	CHR	HEX	DEC	CHR	HEX	DEC	CHR	HEX	DEC	CHR	HEX	DEC
	20	32	0	30	48	@	40	64	P	50	80	'	60	96	p	70	112	Ç	80	128
!	21	33	1	31	49	A	41	65	Q	51	81	a	61	97	q	71	113	ü	81	129
"	22	34	2	32	50	B	42	66	R	52	82	b	62	98	r	72	114	é	82	130
#	23	35	3	33	51	C	43	67	S	53	83	c	63	99	s	73	115	â	83	131
\$	24	36	4	34	52	D	44	68	T	54	84	d	64	100	t	74	116	ä	84	132
%	25	37	5	35	53	E	45	69	U	55	85	e	65	101	u	75	117	à	85	133
&	26	38	6	36	54	F	46	70	V	56	86	f	66	102	v	76	118	å	86	134
'	27	39	7	37	55	G	47	71	W	57	87	g	67	103	w	77	119	ç	87	135
(28	40	8	38	56	H	48	72	X	58	88	h	68	104	x	78	120	ê	88	136
)	29	41	9	39	57	I	49	73	Y	59	89	i	69	105	y	79	121	ë	89	137
*	2a	42	:	3a	58	J	4a	74	Z	5a	90	j	6a	106	z	7a	122	è	8a	138
+	2b	43	;	3b	59	K	4b	75	[5b	91	k	6b	107	{	7b	123	ï	8b	139
,	2c	44	<	3c	60	L	4c	76	¢	5c	92	l	6c	108		7c	124	î	8c	140
-	2d	45	=	3d	61	M	4d	77]	5d	93	m	6d	109	}	7d	125	ì	8d	141
.	2e	46	>	3e	62	N	4e	78	^	5e	94	n	6e	110	~	7e	126	Ä	8e	142
/	2f	47	?	3f	63	O	4f	79	_	5f	95	o	6f	111	◊	7f	127	Å	8f	143

CHR	HEX	DEC	CHR	HEX	DEC	CHR	HEX	DEC	CHR	HEX	DEC	CHR	HEX	DEC	CHR	HEX	DEC	CHR	HEX	DEC
É	90	144	á	a0	160	⋮	b0	176	└	c0	192	ð	d0	208	Ó	e0	224	-	f0	240
æ	91	145	í	a1	161	⊞	b1	177	┘	c1	193	Ð	d1	209	β	e1	225	±	f1	241
Æ	92	146	ó	a2	162	⊞	b2	178	┘	c2	194	È	d2	210	Ò	e2	226	=	f2	242
ô	93	147	ú	a3	163		b3	179	┘	c3	195	Ë	d3	211	Ó	e3	227	¾	f3	243
ö	94	148	ñ	a4	164	┘	b4	180	—	c4	196	È	d4	212	õ	e4	228	¶	f4	244
ò	95	149	Ñ	a5	165	Á	b5	181	+	c5	197	ı	d5	213	Õ	e5	229	§	f5	245
û	96	150	ª	a6	166	À	b6	182	ã	c6	198	í	d6	214	μ	e6	230	÷	f6	246
ù	97	151	º	a7	167	À	b7	183	Ä	c7	199	ï	d7	215	þ	e7	231	¸	f7	247
ÿ	98	152	¿	a8	168	©	b8	184	└	c8	200	İ	d8	216	þ	e8	232	°	f8	248
Ö	99	153	®	a9	169	≡	b9	185	┘	c9	201	┘	d9	217	Ú	e9	233	”	f9	249
Ü	9a	154	¬	aa	170		ba	186	┘	ca	202	┘	da	218	Û	ea	234	•	fa	250
ø	9b	155	½	ab	171	┘	bb	187	┘	cb	203	■	db	219	Ù	eb	235	¹	fb	251
£	9c	156	¼	ac	172	┘	bc	188	┘	cc	204	■	dc	220	ý	ec	236	³	fc	252
Ø	9d	157	ı	ad	173	©	bd	189	=	cd	205		dd	221	Ý	ed	237	²	fd	253
×	9e	158	«	ae	174	¥	be	190	≡	ce	206	ı	de	222	˘	ee	238	■	fe	254
f	9f	159	»	af	175	┘	bf	191	œ	cf	207	■	df	223	˙	ef	239		ff	255

Zebra Code Page 1250 (Scalable/Downloaded TTF) — Central and Eastern European Latin Character Set

This is the Zebra Code Page 1250 that supports scalable/downloaded TTF fonts:



Note • Font 0 (zero) was used to display this chart.

CHR	HEX	DEC	CHR	HEX	DEC	CHR	HEX	DEC	CHR	HEX	DEC	CHR	HEX	DEC	CHR	HEX	DEC	CHR	HEX	DEC			
	20	32	0	30	48	@	40	64	P	50	80	'	60	96	p	70	112	€	80	128			
!	21	33	1	31	49	A	41	65	Q	51	81	a	61	97	q	71	113		81	129			
"	22	34	2	32	50	B	42	66	R	52	82	b	62	98	r	72	114	,	82	130			
#	23	35	3	33	51	C	43	67	S	53	83	c	63	99	s	73	115		83	131			
\$	24	36	4	34	52	D	44	68	T	54	84	d	64	100	t	74	116	„	84	132			
%	25	37	5	35	53	E	45	69	U	55	85	e	65	101	u	75	117	...	85	133			
&	26	38	6	36	54	F	46	70	V	56	86	f	66	102	v	76	118	†	86	134			
'	27	39	7	37	55	G	47	71	W	57	87	g	67	103	w	77	119	‡	87	135			
(28	40	8	38	56	H	48	72	X	58	88	h	68	104	x	78	120		88	136			
)	29	41	9	39	57	I	49	73	Y	59	89	i	69	105	y	79	121	‰	89	137			
*	2a	42	:	3a	58	J	4a	74	Z	5a	90	j	6a	106	z	7a	122	Š	8a	138			
+	2b	43	;	3b	59	K	4b	75	[5b	91	k	6b	107	{	7b	123	◀	8b	139			
,	2c	44	<	3c	60	L	4c	76	\	5c	92	l	6c	108		7c	124	Š	8c	140			
-	2d	45	=	3d	61	M	4d	77]	5d	93	m	6d	109	}	7d	125	Ť	8d	141			
.	2e	46	>	3e	62	N	4e	78	^	5e	94	n	6e	110	~	7e	126	Ž	8e	142			
/	2f	47	?	3f	63	O	4f	79	_	5f	95	o	6f	111		7f	127	Ž	8f	143			

CHR	HEX	DEC	CHR	HEX	DEC	CHR	HEX	DEC	CHR	HEX	DEC	CHR	HEX	DEC	CHR	HEX	DEC	CHR	HEX	DEC
	90	144		a0	160	°	b0	176	Ř	c0	192	Đ	d0	208	í	e0	224	đ	f0	240
‘	91	145	ˇ	a1	161	±	b1	177	Á	c1	193	Ň	d1	209	á	e1	225	ň	f1	241
’	92	146	ˇ	a2	162	˘	b2	178	Ā	c2	194	Ŋ	d2	210	â	e2	226	ñ	f2	242
“	93	147	Ł	a3	163	†	b3	179	Ǻ	c3	195	Ó	d3	211	ǻ	e3	227	ó	f3	243
”	94	148	Ǫ	a4	164	˙	b4	180	ǻ	c4	196	Ö	d4	212	ǻ	e4	228	ô	f4	244
•	95	149	Ą	a5	165	μ	b5	181	Ĺ	c5	197	Ő	d5	213	í	e5	229	ő	f5	245
—	96	150	ı	a6	166	¶	b6	182	Č	c6	198	Ö	d6	214	ć	e6	230	ö	f6	246
—	97	151	§	a7	167	˙	b7	183	Ç	c7	199	×	d7	215	ç	e7	231	÷	f7	247
	98	152	”	a8	168	˘	b8	184	Č	c8	200	Ř	d8	216	č	e8	232	ř	f8	248
™	99	153	©	a9	169	ą	b9	185	É	c9	201	Ů	d9	217	é	e9	233	ů	f9	249
š	9a	154	§	aa	170	ş	ba	186	Ę	ca	202	Ú	da	218	ę	ea	234	ú	fa	250
›	9b	155	«	ab	171	»	bb	187	Ě	cb	203	Ů	db	219	ě	eb	235	ů	fb	251
ś	9c	156	¬	ac	172	Ł	bc	188	Ě	cc	204	Ů	dc	220	ě	ec	236	ü	fc	252
ť	9d	157	-	ad	173	”	bd	189	Í	cd	205	Ý	dd	221	í	ed	237	ý	fd	253
ž	9e	158	®	ae	174	ı	be	190	Ī	ce	206	Ť	de	222	î	ee	238	ț	fe	254
ž	9f	159	Ž	af	175	ž	bf	191	Ď	cf	207	ß	df	223	d'	ef	239	˙	ff	255

Zebra Code Page 1252— Latin Character Set

This is the Zebra Code Page 1252:

CHR	HEX	DEC	CHR	HEX	DEC	CHR	HEX	DEC	CHR	HEX	DEC	CHR	HEX	DEC	CHR	HEX	DEC			
	20	32	0	30	48	@	40	64	P	50	80	`	60	96	p	70	112	€	80	128
!	21	33	1	31	49	A	41	65	Q	51	81	a	61	97	q	71	113		81	129
"	22	34	2	32	50	B	42	66	R	52	82	b	62	98	r	72	114	,	82	130
#	23	35	3	33	51	C	43	67	S	53	83	c	63	99	s	73	115	f	83	131
\$	24	36	4	34	52	D	44	68	T	54	84	d	64	100	t	74	116	„	84	132
%	25	37	5	35	53	E	45	69	U	55	85	e	65	101	u	75	117	...	85	133
&	26	38	6	36	54	F	46	70	V	56	86	f	66	102	v	76	118	†	86	134
'	27	39	7	37	55	G	47	71	W	57	87	g	67	103	w	77	119	‡	87	135
(28	40	8	38	56	H	48	72	X	58	88	h	68	104	x	78	120	^	88	136
)	29	41	9	39	57	I	49	73	Y	59	89	i	69	105	y	79	121	‰	89	137
*	2a	42	:	3a	58	J	4a	74	Z	5a	90	j	6a	106	z	7a	122	Š	8a	138
+	2b	43	;	3b	59	K	4b	75	[5b	91	k	6b	107	{	7b	123	<	8b	139
,	2c	44	<	3c	60	L	4c	76	\	5c	92	l	6c	108		7c	124	Œ	8c	140
-	2d	45	=	3d	61	M	4d	77]	5d	93	m	6d	109	}	7d	125		8d	141
.	2e	46	>	3e	62	N	4e	78	^	5e	94	n	6e	110	~	7e	126	Ž	8e	142
/	2f	47	?	3f	63	O	4f	79	_	5f	95	o	6f	111		7f	127		8f	143

CHR	HEX	DEC	CHR	HEX	DEC	CHR	HEX	DEC	CHR	HEX	DEC	CHR	HEX	DEC	CHR	HEX	DEC	CHR	HEX	DEC
	90	144		a0	160	°	b0	176	À	c0	192	Ð	d0	208	à	e0	224	ö	f0	240
‘	91	145	í	a1	161	±	b1	177	Á	c1	193	Ñ	d1	209	á	e1	225	ñ	f1	241
’	92	146	¢	a2	162	²	b2	178	Â	c2	194	Ò	d2	210	â	e2	226	ò	f2	242
“	93	147	£	a3	163	³	b3	179	Ã	c3	195	Ó	d3	211	ã	e3	227	ó	f3	243
”	94	148	¤	a4	164	´	b4	180	Ä	c4	196	Ô	d4	212	ä	e4	228	ô	f4	244
•	95	149	¥	a5	165	µ	b5	181	Å	c5	197	Õ	d5	213	å	e5	229	õ	f5	245
—	96	150		a6	166	¶	b6	182	Æ	c6	198	Ö	d6	214	æ	e6	230	ö	f6	246
—	97	151	§	a7	167	·	b7	183	Ç	c7	199	×	d7	215	ç	e7	231	÷	f7	247
~	98	152	¨	a8	168	¸	b8	184	È	c8	200	Ø	d8	216	è	e8	232	ø	f8	248
™	99	153	©	a9	169	¹	b9	185	É	c9	201	Ù	d9	217	é	e9	233	ù	f9	249
š	9a	154	à	aa	170	º	ba	186	Ê	ca	202	Ú	da	218	ê	ea	234	ú	fa	250
›	9b	155	«	ab	171	»	bb	187	Ë	cb	203	Û	db	219	ë	eb	235	û	fb	251
œ	9c	156	¬	ac	172	¼	bc	188	Ì	cc	204	Ü	dc	220	ì	ec	236	ü	fc	252
	9d	157	-	ad	173	½	bd	189	Í	cd	205	Ý	dd	221	í	ed	237	ý	fd	253
ž	9e	158	®	ae	174	¾	be	190	Î	ce	206	Þ	de	222	î	ee	238	þ	fe	254
ÿ	9f	159	¯	af	175	¿	bf	191	Ï	cf	207	ß	df	223	ï	ef	239	ÿ	ff	255

Zebra Code Page 1253 — Modern Greek Character Set

This is the Zebra Code Page 1253:

CHR	HEX	DEC	CHR	HEX	DEC	CHR	HEX	DEC	CHR	HEX	DEC	CHR	HEX	DEC	CHR	HEX	DEC	CHR	HEX	DEC			
	0	0		1	1		20	32	0	30	48	@	40	64	P	50	80	'	60	96	p	70	112
	2	2		3	3	!	21	33	1	31	49	A	41	65	Q	51	81	a	61	97	q	71	113
	4	4		5	5	"	22	34	2	32	50	B	42	66	R	52	82	b	62	98	r	72	114
	6	6		7	7	#	23	35	3	33	51	C	43	67	S	53	83	c	63	99	s	73	115
	8	8		9	9	\$	24	36	4	34	52	D	44	68	T	54	84	d	64	100	t	74	116
	a	10		b	11	%	25	37	5	35	53	E	45	69	U	55	85	e	65	101	u	75	117
	c	12		d	13	&	26	38	6	36	54	F	46	70	V	56	86	f	66	102	v	76	118
	e	14		f	15	'	27	39	7	37	55	G	47	71	W	57	87	g	67	103	w	77	119
	10	16		11	17	(28	40	8	38	56	H	48	72	X	58	88	h	68	104	x	78	120
	12	18		13	19)	29	41	9	39	57	I	49	73	Y	59	89	i	69	105	y	79	121
	14	20		15	21	*	2a	42	:	3a	58	J	4a	74	Z	5a	90	j	6a	106	z	7a	122
	16	22		17	23	+	2b	43	;	3b	59	K	4b	75	[5b	91	k	6b	107	{	7b	123
	18	24		19	25	,	2c	44	<	3c	60	L	4c	76	\	5c	92	l	6c	108		7c	124
	1a	26		1b	27	-	2d	45	=	3d	61	M	4d	77]	5d	93	m	6d	109	}	7d	125
	1c	28		1d	29	.	2e	46	>	3e	62	N	4e	78	^	5e	94	n	6e	110	~	7e	126
	1e	30		1f	31	/	2f	47	?	3f	63	O	4f	79	_	5f	95	o	6f	111		7f	127

CHRHEXDEC	CHRHEXDEC	CHRHEXDEC	CHRHEXDEC	CHRHEXDEC	CHRHEXDEC	CHRHEXDEC	CHRHEXDEC
€ 80 128	90 144	̂ 160	° b0 176	Τ c0 192	Π d0 208	Û e0 224	π f0 240
81 129	' 91 145	" ̂ 161	± b1 177	Α c1 193	Ρ d1 209	α e1 225	ρ f1 241
, 82 130	92 146	Α ̂ 162	² b2 178	Β c2 194	d2 210	β e2 226	ς f2 242
f 83 131	" 93 147	£ a3 163	³ b3 179	Γ c3 195	Σ d3 211	γ e3 227	σ f3 243
84 132	" 94 148	α a4 164	b4 180	Δ c4 196	Τ d4 212	δ e4 228	τ f4 244
... 85 133	95 149	¥ a5 165	μ b5 181	Ε c5 197	Υ d5 213	ε e5 229	υ f5 245
† 86 134	- 96 150	a6 166	¶ b6 182	Ζ c6 198	Φ d6 214	ζ e6 230	φ f6 246
‡ 87 135	- 97 151	§ a7 167	b7 183	Η c7 199	Χ d7 215	η e7 231	χ f7 247
88 136	98 152	" ̂ 168	Έ b8 184	Θ c8 200	Ψ d8 216	θ e8 232	ψ f8 248
89 137	™ 99 153	© a9 169	Η b9 185	Ι c9 201	Ω d9 217	ι e9 233	ω f9 249
8a 138	9a 154	̂ 170	ΐ ba 186	Κ ca 202	Ι da 218	κ ea 234	ϊ fa 250
' 8b 139	' 9b 155	" ̂ 171	bb 187	Λ cb 203	Υ db 219	λ eb 235	ϋ fb 251
8c 140	9c 156	̂ 172	Ό bc 188	Μ cc 204	ά dc 220	μ ec 236	ό fc 252
8d 141	9d 157	̂ 173	½ bd 189	Ν cd 205	έ dd 221	ν ed 237	ύ fd 253
8e 142	9e 158	® ae 174	ΰ be 190	Ξ ce 206	ή de 222	ξ ee 238	ώ fe 254
8f 143	9f 159	- af 175	Ω bf 191	Ο cf 207	ι df 223	ο ef 239	ff 255

Zebra Code Page 1254 — Turkish Character Set

This is the Zebra Code Page 1254:

CHR	HEX	DEC	CHR	HEX	DEC	CHR	HEX	DEC	CHR	HEX	DEC	CHR	HEX	DEC	CHR	HEX	DEC	CHR	HEX	DEC			
0	0		1	1		20	32		0	30	48	@	40	64	P	50	80	'	60	96	p	70	112
2	2		3	3		!	21	33	1	31	49	A	41	65	Q	51	81	a	61	97	q	71	113
4	4		5	5		"	22	34	2	32	50	B	42	66	R	52	82	b	62	98	r	72	114
6	6		7	7		#	23	35	3	33	51	C	43	67	S	53	83	c	63	99	s	73	115
8	8		9	9		\$	24	36	4	34	52	D	44	68	T	54	84	d	64	100	t	74	116
a	10		b	11		%	25	37	5	35	53	E	45	69	U	55	85	e	65	101	u	75	117
c	12		d	13		&	26	38	6	36	54	F	46	70	V	56	86	f	66	102	v	76	118
e	14		f	15		'	27	39	7	37	55	G	47	71	W	57	87	g	67	103	w	77	119
10	16		11	17		(28	40	8	38	56	H	48	72	X	58	88	h	68	104	x	78	120
12	18		13	19)	29	41	9	39	57	I	49	73	Y	59	89	i	69	105	y	79	121
14	20		15	21		*	2a	42	:	3a	58	J	4a	74	Z	5a	90	j	6a	106	z	7a	122
16	22		17	23		+	2b	43	;	3b	59	K	4b	75	[5b	91	k	6b	107	{	7b	123
18	24		19	25		,	2c	44	<	3c	60	L	4c	76	\	5c	92	l	6c	108		7c	124
1a	26		1b	27		-	2d	45	=	3d	61	M	4d	77]	5d	93	m	6d	109	}	7d	125
1c	28		1d	29		.	2e	46	>	3e	62	N	4e	78	^	5e	94	n	6e	110	~	7e	126
1e	30		1f	31		/	2f	47	?	3f	63	O	4f	79	_	5f	95	o	6f	111		7f	127

CHRHEXDEC		CHRHEXDEC		CHRHEXDEC		CHRHEXDEC		CHRHEXDEC		CHRHEXDEC		CHRHEXDEC		CHRHEXDEC									
€	80	128		90	144		a0	160	°	b0	176	À	c0	192	Ĝ	d0	208	à	e0	224	ğ	f0	240
	81	129	'	91	145	ı	a1	161	±	b1	177	Á	c1	193	Ñ	d1	209	á	e1	225	ñ	f1	241
,	82	130	'	92	146	Ç	a2	162	²	b2	178	Â	c2	194	Ò	d2	210	â	e2	226	ó	f2	242
/	83	131	"	93	147	£	a3	163	³	b3	179	Ã	c3	195	Ó	d3	211	ã	e3	227	ô	f3	243
„	84	132	"	94	148	α	a4	164		b4	180	Ä	c4	196	Ö	d4	212	ä	e4	228	õ	f4	244
...	85	133	'	95	149	¥	a5	165	μ	b5	181	Å	c5	197	Ø	d5	213	å	e5	229	ö	f5	245
†	86	134	-	96	150		a6	166	¶	b6	182	Æ	c6	198	Ɔ	d6	214	æ	e6	230	ø	f6	246
‡	87	135	-	97	151	\$	a7	167	'	b7	183	Ç	c7	199	×	d7	215	ç	e7	231	÷	f7	247
^	88	136	~	98	152	"	a8	168	,	b8	184	È	c8	200	Ɔ	d8	216	è	e8	232	ø	f8	248
‰	89	137	™	99	153	©	a9	169	¹	b9	185	É	c9	201	Ù	d9	217	é	e9	233	ù	f9	249
Š	8a	138	š	9a	154	ª	aa	170	º	ba	186	Ê	ca	202	Ú	da	218	ê	ea	234	ú	fa	250
‘	8b	139	’	9b	155	«	ab	171	»	bb	187	Ë	cb	203	Û	db	219	ë	eb	235	û	fb	251
Œ	8c	140	œ	9c	156	¬	ac	172	¼	bc	188	Ì	cc	204	Ü	dc	220	ì	ec	236	ü	fc	252
	8d	141		9d	157	•	ad	173	½	bd	189	Í	cd	205	İ	dd	221	í	ed	237	ı	fd	253
	8e	142		9e	158	®	ae	174	¾	be	190	Î	ce	206	Ş	de	222	î	ee	238	ş	fe	254
	8f	143	ÿ	9f	159		af	175	¿	bf	191	Ï	cf	207	ß	df	223	ï	ef	239	ÿ	ff	255

Zebra Code Page 1255 — Hebrew Character Set

This is the Zebra Code Page 1255:

CHR	HEX	DEC	CHR	HEX	DEC	CHR	HEX	DEC	CHR	HEX	DEC	CHR	HEX	DEC	CHR	HEX	DEC	CHR	HEX	DEC			
0	0		1	1		20	32		0	30	48	@	40	64	P	50	80	'	60	96	p	70	112
2	2		3	3		!	21	33	1	31	49	A	41	65	Q	51	81	a	61	97	q	71	113
4	4		5	5		"	22	34	2	32	50	B	42	66	R	52	82	b	62	98	r	72	114
6	6		7	7		#	23	35	3	33	51	C	43	67	S	53	83	c	63	99	s	73	115
8	8		9	9		\$	24	36	4	34	52	D	44	68	T	54	84	d	64	100	t	74	116
a	10		b	11		%	25	37	5	35	53	E	45	69	U	55	85	e	65	101	u	75	117
c	12		d	13		&	26	38	6	36	54	F	46	70	V	56	86	f	66	102	v	76	118
e	14		f	15		'	27	39	7	37	55	G	47	71	W	57	87	g	67	103	w	77	119
10	16		11	17		(28	40	8	38	56	H	48	72	X	58	88	h	68	104	x	78	120
12	18		13	19)	29	41	9	39	57	I	49	73	Y	59	89	i	69	105	y	79	121
14	20		15	21		*	2a	42	:	3a	58	J	4a	74	Z	5a	90	j	6a	106	z	7a	122
16	22		17	23		+	2b	43	;	3b	59	K	4b	75	[5b	91	k	6b	107	{	7b	123
18	24		19	25		,	2c	44	<	3c	60	L	4c	76	\	5c	92	l	6c	108		7c	124
1a	26		1b	27		-	2d	45	=	3d	61	M	4d	77]	5d	93	m	6d	109	}	7d	125
1c	28		1d	29		.	2e	46	>	3e	62	N	4e	78	^	5e	94	n	6e	110	~	7e	126
1e	30		1f	31		/	2f	47	?	3f	63	O	4f	79	_	5f	95	o	6f	111		7f	127

CHR	HEX	DEC	CHR	HEX	DEC	CHR	HEX	DEC	CHR	HEX	DEC	CHR	HEX	DEC	CHR	HEX	DEC	CHR	HEX	DEC			
€	80	128		90	144		a0	160	°	b0	176	.	c0	192		d0	208	κ	e0	224	ן	f0	240
	81	129	'	91	145	ı	a1	161	±	b1	177	..	c1	193		d1	209	ך	e1	225	ו	f1	241
,	82	130	'	92	146	ץ	a2	162	²	b2	178	..	c2	194		d2	210	ל	e2	226	י	f2	242
f	83	131	"	93	147	£	a3	163	³	b3	179	..	c3	195	:	d3	211	ג	e3	227	ף	f3	243
„	84	132	"	94	148	ן	a4	164		b4	180	.	c4	196	ן	d4	212	ה	e4	228	צ	f4	244
...	85	133	'	95	149	¥	a5	165	μ	b5	181	..	c5	197	"	d5	213	ו	e5	229	ץ	f5	245
†	86	134	-	96	150		a6	166	¶	b6	182	..	c6	198	"	d6	214	י	e6	230	ץ	f6	246
‡	87	135	-	97	151	§	a7	167	'	b7	183	.	c7	199	'	d7	215	ן	e7	231	פ	f7	247
^	88	136	~	98	152	"	a8	168	.	b8	184	.	c8	200	"	d8	216	ו	e8	232	ך	f8	248
0/0	89	137	™	99	153	©	a9	169	ı	b9	185		c9	201		d9	217	'	e9	233	י	f9	249
	8a	138		9a	154	×	aa	170	÷	ba	186		ca	202		da	218	ך	ea	234	ן	fa	250
'	8b	139	'	9b	155	“	ab	171	”	bb	187	..	cb	203		db	219	ך	eb	235		fb	251
	8c	140		9c	156	⌒	ac	172	¼	bc	188	.	cc	204		dc	220	ך	ec	236		fc	252
	8d	141		9d	157	•	ad	173	½	bd	189	.	cd	205		dd	221	ו	ed	237		fd	253
	8e	142		9e	158	®	ae	174	¾	be	190	'	ce	206		de	222	ן	ee	238		fe	254
	8f	143		9f	159		af	175	ı	bf	191	'	cf	207		df	223	י	ef	239		ff	255

ASCII

This section shows the American Standard Code for Information Interchange (ASCII) code used by Zebra printers.

ASCII Code Chart

Shaded areas in [Table 31](#) indicate characters not recommended for command prefix, format prefix, or delimiter characters.

Table 31 • Zebra Used ASCII Code

HEX	Character	HEX	Character	HEX	Character	HEX	Character
00	NUL	20	Space	40	@	60	`
01	SOH	21	!	41	A	61	a
02	STX	22	“	42	B	62	b
03	ETX	23	#	43	C	63	c
04	EOT	24	\$	44	D	64	d
05	ENQ	25	%	45	E	65	e
06	ACK	26	&	46	F	66	f
07	BEL	27	‘	47	G	67	g
08	BS	28	(48	H	68	h
09	HT	29)	49	I	69	i
0A	LF	2A	*	4A	J	6A	j
0B	VT	2B	+	4B	K	6B	k
0C	FF	2C	,	4C	L	6C	l
0D	CR	2D	-	4D	M	6D	m
0E	SO	2E	.	4E	N	6E	n
0F	SI	2F	/	4F	O	6F	o
10	DLE	30	0	50	P	70	p
11	DC1	31	1	51	Q	71	q
12	DC2	32	2	52	R	72	r
13	DC3	33	3	53	S	73	s
14	DC4	34	4	54	T	74	t
15	NAK	35	5	55	U	75	u
16	SYN	36	6	56	V	76	v
17	ETB	37	7	57	W	77	w
18	CAN	38	8	58	X	78	x
19	EM	39	9	59	Y	79	y
1A	SUB	3A	:	5A	Z	7A	z
1B	ESC	3B	;	5B	[7B	{
1C	FS	3C	<	5C	\	7C	
1D	GS	3D	=	5D]	7D	}
1E	RS	3E	>	5E	^	7E	~
1F	US	3F	?	5F	_	7F	DEL

Fonts and Bar Codes

This section provides information about different fonts (type faces) and bar codes that can be used with the printer.

Contents

Standard Printer Fonts	1210
Proportional and Fixed Spacing	1212
Scalable Versus Bitmapped Fonts	1213
Font Matrices	1215
Bar Codes	1217

Standard Printer Fonts

Most Zebra printers come standard with 15 bitmapped fonts and one scalable font, see [Figure 4](#). Additional downloadable bitmapped and scalable fonts are also available. Character size and density (how dark it appears) depend on the density of the printhead and the media used.

Figure 4 • Examples of the Standard Printer Fonts

FONT A -- ABCDwxyz 12345
FONT B -- ABCDXYZ 12345 UPPER CASE ONLY
FONT D -- ABCDwxyz 12345
FONT E -- (OCR-B) ABCDwxyz 12345
FONT F -- ABCDwxyz 12345
FONT G -- **AByz 12**
FONT H -- (OCR-A) UPPER CASE ONLY
zero — **FONT O** -- (Scaleable) ABCDwxyz 12345
FONT GS -- © © ™ ® Accessed with the ^GS command.
FONT P -- ABCDwxyz 12345
FONT Q -- ABCDwxyz 12345
FONT R -- ABCDwxyz 12345
FONT S -- ABCDwxyz 12345
FONT T -- ABCDwxyz 12345
FONT U -- ABCDwxyz 12345
FONT V -- ABCDwxyz 12345

To use one of these fonts, you must either use the change alphanumeric default font command (^CF) or specify an alphanumeric field command (^A).

The standard Zebra character set is Code 850 for character values greater than 20 HEX. There are six HEX character values below 20 HEX that are also recognized. [Figure 5](#) shows how these character values are printed.



Note • Unidentified characters should default to a space.

Figure 5 • Recognized HEX Values below 20 HEX

A HEX	1a	will print a	0 (numeric)
A HEX	1b	will print a	$\frac{1}{3}$
A HEX	1c	will print a	$\frac{2}{3}$
A HEX	1d	will print a	U
A HEX	1e	will print a	ij
A HEX	1f	will print a	\

Proportional and Fixed Spacing

Proportional spacing is different than fixed spacing. In Table 32, the intercharacter gap (ICG), the space between characters, is constant for fonts A through H, which means that the spacing between all characters is the same. For example, the spacing between the letters MW is the same as between the letters IE.

Figure 6 is an example of fixed space fonts:

Figure 6 • Fixed Space Fonts Proportion

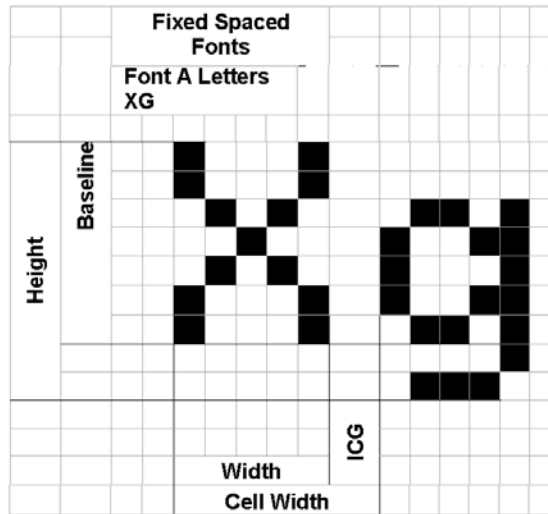

The baseline is the imaginary line on which the bottom (base) of all characters (except any descenders) rest. The area between the baseline and the bottom of the matrix is used for any character “descenders.” Baseline numbers define where the baseline is located in relationship to the top of the matrix. For example, the baseline for font “E” is 23 dots down from the top of the matrix.

Table 32 • Intercharacter Gap and Baseline Parameters

Font	H x W (in dots)	Type	Intercharacter Gap (in dots)	Baseline (in dots)
A	9 x 5	U-L-D	1	7
B	11 x 7	U	2	11
C,D	18 x 10	U-L-D	2	14
E	28 x 15	OCR-B	5	23
F	26 x 13	U-L-D	3	21
G	60 x 40	U-L-D	8	48
H	21 x 13	OCR-A	6	21
GS	24 x 24	SYMBOL	PROPORTIONAL	3 x HEIGHT/4
0	DEFAULT: 15 x 12		PROPORTIONAL	3 x HEIGHT/4

Scalable Versus Bitmapped Fonts

For scalable fonts, setting the height and width equally produces characters that appear the most balanced. Balanced characters are pleasing to the eye because actual height and width are approximately equal to each other. This is achieved through the use of a smooth-scaling algorithm in the printer.

For bitmapped fonts, this balancing is built into the font. In actuality, the height of a bitmap font is slightly larger than the width. Bitmap fonts are always at the maximum size of the character's cell.

Scalable Fonts

All dot parameters used in the commands to create scalable fonts are translated into a point size because scalable fonts are measured in point sizes, not dots. To determine how many dots to enter to obtain a particular point size, use the following formula. The actual point size will be an approximate value.

$$\text{Dots} = \frac{(\text{Point size}) \times (\text{Dots per inch of Printer})}{72}$$

- For printers using a 6 dot/mm printhead the “dots per inch of printer” value is 152.4
- For printers using a 8 dot/mm printhead the “dots per inch of printer” value is 203.2
- For printers using a 12 dot/mm printhead the “dots per inch of printer” value is 304.8
- For printers using a 24 dot/mm printhead the “dots per inch of printer” value is 609.6

The actual height and width of the character in dots will vary, depending on the font style and the particular character. Therefore, some characters will be smaller and some will be larger than the actual dot size requested. The baselines for all scalable fonts are calculated against the dot size of the cell. The baseline is 3/4 down from the top of the cell. For example, if the size of the cell is 80 dots, the baseline will be 60 dots (3/4) down from the top of the cell.

For more information concerning fonts and related commands, see [~DB on page 168](#) and [~DS on page 177](#).

Bitmapped Fonts

Internal bitmapped fonts can be magnified from 1 to 10 times their normal (default) size. The magnification factor is in whole numbers. Therefore, if the normal size of a bitmapped font is 9 dots high and 5 dots wide, a magnification factor of 3 would produce a character of 27 dots high and 15 dots wide. Height and width can be magnified independently.

Magnification Factor

The font commands contain parameters for entering the height and width of printed characters. The values are always entered in dots. When entering these values for bitmapped fonts, use the following formula:

$$\text{Base Height} \times \text{Magnification Factor} = \text{Height Parameter Value}$$

The same principle applies when calculating width.

Example:

Base height = 9 dots

Base width = 5 dots

To magnify a bitmapped character with the above specifics 3 times its size:

Height parameter = 27 [9 x 3]

Width parameter = 15 [5 x 3]

Changing Bitmapped Font Size

Alphanumeric field command (^A) parameters h and w control the magnification and, therefore, the ultimate size of the font. The parameter is specified in dots, but ZPL II actually uses an integer multiplier times the original height/width of the font. For example, if you specify

`^AD,54`

you get characters three times their normal size (54 dots high), but if you specify

`^AD,52`

you receive the same result, not characters 52 dots high.

Defining only the height or width of a bitmapped font forces the magnification to be proportional to the parameter defined. If neither is defined, the ^CF height and width are used. For example, if the height is twice the standard height, the width will be twice the standard width.



Example • If a ^CF command, with height and width parameters defined, is used to set the first font, any ^A commands (to select a different font) that follow must have the height and width parameter filled in.

If this is not done, the newly selected font will be magnified using values for the ^CF height and width parameters. This is an example of what happens:.

ZPL II CODE	GENERATED LABEL
<pre> ^XA^LL1800 ^FO50,50^CFD,26,10^FDZEBRA...^FS ^FO50,100^FD"Bar Code, Bar None"^FS ^FO50,200^AA^FDZEBRA...^FS ^FO50,250^FD"Bar Code, Bar None"^FS ^XZ </pre>	

Font Matrices

Type Key U = Uppercase, L = Lowercase, D = Descenders

Table 33 • 6 dot/mm Printhead

Font	Matrix	Type	Character Size			
	HxW (in dots)		HxW (in in.)	Char./in.	HxW (in mm)	Char. /mm
A	9 x 5	U-L-D	0.059 x 0.039	25.4	1.50 x 0.99	1.01
B	11 x 7	U	0.072 x 0.059	16.9	1.82 x 1.50	0.066
C, D	18 x 10	U-L-D	0.118 x 0.079	12.7	2.99 x 2.00	0.05
E	21 x 10	OCR-B	0.138 x 0.085	11.7	3.50 x 2.16	0.46
F	26 x 13	U-L-D	0.170 x 0.105	9.53	4.32 x 2.67	0.37
G	60 x 40	U-L-D	0.394 x 0.315	3.18	10.0 x 8.00	0.125
H	17 x 11	OCR-A	0.111 x 0.098	10.2	2.81 x 2.48	0.40
GS	24 x 24	SYMBOL	0.157 x 0.157	6.35	3.98 x 3.98	0.251
0	Default: 15 x 12					

Table 34 • 8 dot/mm (203 dpi) Printhead

Font	Matrix	Type	Character Size			
	HxW (in dots)		HxW (in in.)	Char./in.	HxW (in mm)	Char. /mm
A	9 X 5	U-L-D	0.044 x 0.030	33.3	1.12 x 0.76	1.31
B	11 X 7	U	0.054 x 0.044	22.7	1.37 x 1.12	0.89
C, D	18 X 10	U-L-D	0.089 x 0.059	16.9	2.26 x 1.12	0.66
E	28 x 15	OCR-B	0.138 x 0.098	10.2	3.50 x 2.49	0.40
F	26 x 13	U-L-D	0.128 x 0.079	12.7	3.25 x 2.00	0.50
G	60 x 40	U-L-D	0.295 x 0.197	4.2	7.49 x 5.00	0.167
H	21 x 13	OCR-A	0.103 x 0.093	10.8	2.61 x 2.36	0.423
GS	24 x 24	SYMBOL	0.118 x 0.118	8.5	2.99 x 2.99	0.334
P	20 x 18	U-L-D	0.098 x 0.089	N/A	2.50 x 2.25	N/A
Q	28 x 24	U-L-D	0.138 x 0.118	N/A	3.50 x 3.00	N/A
R	35 x 31	U-L-D	0.172 x 0.153	N/A	4.38 x 3.88	N/A
S	40 x 35	U-L-D	0.197 x 0.172	N/A	5.00 x 4.38	N/A
T	48 x 42	U-L-D	0.236 x 0.207	N/A	6.00 x 5.25	N/A
U	59 x 53	U-L-D	0.290 x 0.261	N/A	7.38 x 6.63	N/A
V	80 x 71	U-L-D	0.394 x 0.349	N/A	10.00 x 8.88	N/A
0	Default: 15 x 12	U-L-D	Scalable		Scalable	

Table 35 • 12 dot/mm (300 dpi) Printhead

Font	Matrix	Type	Character Size			
	HxW (in dots)		HxW (in in.)	Char./in.	HxW (in mm)	Char. /mm
A	9 X 5	U-L-D	0.030 x 0.020	50.8	0.75 x 0.50	2.02
B	11 X 7	U	0.036 x 0.030	33.8	0.91 x 0.75	1.32
C, D	18 X 10	U-L-D	0.059 x 0.040	25.4	1.50 x 1.00	1.00
E	42 x 20	OCR-B	0.138 x 0.085	23.4	1.75 x 1.08	0.92
F	26 x 13	U-L-D	0.085 x 0.053	19.06	2.16 x 1.34	0.74
G	60 x 40	U-L-D	0.197 x 0.158	6.36	5.00 x 4.00	0.25
H	34 x 22	OCR-A	0.111 x 0.098	10.20	2.81 x 2.48	0.40
GS	24 x 24	SYMBOL	0.079 x 0.079	12.70	1.99 x 1.99	0.52
P	20 x 18	U-L-D	0.067 x 0.060	N/A	1.69 x 1.52	N/A
Q	28 x 24	U-L-D	0.093 x 0.080	N/A	2.37 x 2.03	N/A
R	35 x 31	U-L-D	0.117 x 0.103	N/A	2.96 x 2.62	N/A
S	40 x 35	U-L-D	0.133 x 0.177	N/A	3.39 x 2.96	N/A
T	48 x 42	U-L-D	0.160 x 0.140	N/A	4.06 x 3.56	N/A
U	59 x 53	U-L-D	0.197 x 0.177	N/A	5.00 x 4.49	N/A
V	80 x 71	U-L-D	0.267 x 0.237	N/A	6.77 x 6.01	N/A
0	Default: 15 x 12	U-L-D	Scalable		Scalable	

Table 36 • 24 dot/mm (600 dpi) Printhead

Font	Matrix	Type	Character Size			
	HxW (in dots)		HxW (in in.)	Char./in.	HxW (in mm)	Char. /mm
A	9 X 5	U-L-D	0.015 x 0.010	100.00	0.38 x 0.25	4.00
B	11 X 7	U	0.018 x 0.015	66.66	0.46 x 0.38	2.60
C, D	18 X 10	U-L-D	0.030 x 0.020	50.00	0.77 x 0.51	2.0
E	42 x 20	OCR-B	0.137 x 0.087	11.54	3.47 x 2.20	0.45
F	26 x 13	U-L-D	0.043 x 0.027	37.5	1.10 x 0.68	1.50
G	60 x 40	U-L-D	0.100 x 0.080	12.50	2.54 x 2.04	0.50
H	34 x 22	OCR-A	0.100 x 0.093	10.71	2.54 x 2.37	0.42
GS	24 x 24	SYMBOL	0.040 x 0.040	25.00	1.02 x 1.02	1.00
P	20 x 18	U-L-D	0.067 x 0.060	N/A	1.69 x 1.52	N/A
Q	28 x 24	U-L-D	0.093 x 0.080	N/A	2.37 x 2.03	N/A
R	35 x 31	U-L-D	0.117 x 0.103	N/A	2.96 x 2.62	N/A
S	40 x 35	U-L-D	0.133 x 0.117	N/A	3.39 x 2.96	N/A
T	48 x 42	U-L-D	0.160 x 0.140	N/A	4.06 x 3.56	N/A
U	59 x 53	U-L-D	0.197 x 0.177	N/A	5.00 x 4.49	N/A
V	80 x 71	U-L-D	0.267 x 0.237	N/A	6.77 x 6.01	N/A
0	Default: 15 x 12	U-L-D	Scalable		Scalable	

Bar Codes

Every bar code contains data made up of a sequence of light spaces and dark bars that represent letters, numbers, or other graphic characters. The usable characters differ among the various kinds of bar codes. Each bar code section in the *ZPL Commands on page 47* provides a table of applicable characters. Start and stop characters and check digits are used by many, but not all, bar codes. These will be indicated in the specific bar code explanations.

Zebra printers can print the following kinds of bar codes:

<p>Bar code modulus “X” dimensions</p> <ul style="list-style-type: none"> • Picket fence (non-rotated) orientation: <ul style="list-style-type: none"> • 203 dpi = 0.0049 in. mil to 0.049 in. • 300 dpi = 0.0033 in. mil to 0.033 in. • Ladder (rotated) orientation: <ul style="list-style-type: none"> • 203 dpi = 0.0049 in. mil to 0.049 in. • 300 dpi = 0.0039 in. mil to 0.039 in. 	<p>Linear bar codes</p> <ul style="list-style-type: none"> • Codabar • Code 11 • Code 39 • Code 93 • Code 128 with subsets A/B C and UCC Case Codes • ISBT-128 • UPC-A • UPC-E • EAN-8 • EAN-13 • UPC and EAN 2 or 5 digit extensions • Planet Code • Plessey • Postnet • Standard 2 of 5 • Industrial 2 of 5 • Interleaved 2 of 5 • LOGMARS • MSI • GS1 DataBar Omnidirectional
<p>Two-dimensional bar codes</p> <ul style="list-style-type: none"> • Aztec • Code 49 • Maxi Code • TLC39 • PDF-417 • QR Code • Codablock • DataMatrix • Micro-PDF417 	
<p>Bar code ratios</p> <ul style="list-style-type: none"> • 2:1 • 7:3 • 5:2 • 3:1 	

Basic Format for Bar Codes

The basic format for bar codes is quiet zone, start character, data, check digit, stop character, and quiet zone. Not all bar codes require each of these elements.

Every bar code requires a quiet zone. A quiet zone (sometimes called a “clear area”) is an area adjacent to the machine-readable symbols that ensure proper reading (decoding) of the symbols. No printing is permissible within this area. Preprinted characters, borders, and background color are acceptable if they are invisible to the reading device; these are used in some applications but restrict the type of reading device that can be used. The size of the quiet zone depends on the size of bar widths (usually 10 times the width of the narrow bar).

Figure 7 • Quiet Zone in a Bar Code



Bar Code Field Instructions

To create a bar code, a bar code field command must be contained in the label format. [Table 37](#) shows the bar code field commands. The number in brackets denotes the print ratio. Each command produces a unique bar code.



Important • (*) for Fixed Printing Ratio means that the ratio between the width of the bars in the code is a fixed standard and cannot be changed.

As another reference to the bar code field commands ratio, see [Table 11 on page 147](#).

Table 37 • Bar Code Field Commands

ZPL Command	Command Description	Ratio
^B0	Aztec Bar Code Parameters	[Fixed]
^B1	Code 11 (USD-8)	[2.0 - 3.0]
^B2	Interleaved 2 of 5	[2.0 - 3.0]
^B3	Code 39 (USD-3 and 3 of 9)	[2.0 - 3.0]
^B4	Code 49 (*)	[Fixed]
^B5	Planet Code Bar Code	[Fixed]
^B7	PDF417 (*)	[Fixed]
^B8	EAN-8 (*)	[Fixed]
^B9	UPC-E	[Fixed]
^BA	Code 93 (USS-93)(*)	[Fixed]
^BB	CODABLOCK A, E, F (*)	[Fixed]
^BC	Code 128 (USD-6) (*)	[Fixed]
^BD	UPS MaxiCode (*)	[Fixed]
^BE	EAN-13	[Fixed]
^BF	Micro-PDF417	[Fixed]

Table 37 • Bar Code Field Commands (Continued)

ZPL Command	Command Description	Ratio
^BI	Industrial 2 of 5	[2.0 - 3.0]
^BJ	Standard 2 of 5	[2.0 - 3.0]
^BK	ANSI Codabar (USD-4 and 2 of 7)	[2.0 - 3.0]
^BL	LOGMARS	[2.0 - 3.0]
^BM	MSI	[2.0 - 3.0]
^BO	Aztec Bar Code Parameters	[Fixed]
^BP	Plessey	[2.0 - 3.0]
^BQ	QR Code (*)	[Fixed]
^BR	GS1 Databar (formerly RSS)	[Fixed]
^BS	UPC/EAN Extensions (*)	[Fixed]
^BU	UPC-A (*)	[Fixed]
^BX	Data Matrix (*)	[Fixed]
^BZ	PostNet (*), USPS Intelligent Mail, and Planet bar codes	[Fixed]

Additionally, each bar code field command can be issued with a definition parameter string. The parameter string defines field rotation, height, and interpretation line status for all bar codes. For some bar codes, the parameter string also sets a check digit, start character, and/or stop character. Use the definition parameter string to command the printer to print bar codes of appropriate heights and densities that conform to the specifications of the application.

The use of the parameter string is optional because all parameters have default values. If the default values for all of the bar code parameters suit the application, then only the bar code command needs to be entered.

Parameters in bar code field commands are “position specific.” If a value (other than the default value) is manually entered for one parameter the ZPL II delimiter character (a comma) must be used to mark the position of the preceding parameters in the string.

To change just the third parameter, enter two commas and then the value for the third parameter. The default values will be automatically used for the first and second parameters.

Bar Code Command Groups

Bar code commands are organized into four groups. Each group represents a type of bar code. Table 38 through Table 41 identify the groups and the bar codes they contain:

Table 38 • Numeric Only Bar Codes

ZPL Command	Command Description
^B0	Aztec Bar Code Parameters
^B1	Code 11
^B5	Planet Code Bar Code
^BI	Industrial 2 of 5
^BJ	Standard 2 of 5
^BK	ANSI Codabar (or NW-7)
^BM	MSI
^B0	Aztec Bar Code Parameters
^BP	Plessey
^BZ	PostNet (*), USPS Intelligent Mail, and Planet bar codes

Table 39 • Retail Labeling Bar Codes

ZPL Command	Command Description
^B0	Aztec Bar Code Parameters
^B8	EAN-8
^B9	UPC-E
^BE	EAN-13
^B0	Aztec Bar Code Parameters
^BS	UPC/EAN extensions
^BU	UPC-A

Table 40 • Alphanumeric Bar Codes

ZPL Command	Command Description
^B0	Aztec Bar Code Parameters
^B3	Code 39
^BA	Code 93
^BC	Code 128
^BL	LOGMARS
^B0	Aztec Bar Code Parameters

Table 41 • Two-Dimensional Bar Codes

ZPL Command	Command Description
^B0	Aztec Bar Code Parameters
^B4	Code 49
^B7	PDF417
^BB	CODABLOCK
^BD	UPS MaxiCode
^BF	MicroPDF417
^BQ	QR Code
^B0	Aztec Bar Code Parameters
^BR	GS1 Databar (formerly RSS)
^BT	TLC39
^BX	Data Matrix

Mod 10 and Mod 43 Check Digits

This section provides information about Mod 10 and Mod 43 check digits.

Contents

Mod 10 Check Digit	1224
Mod 43 Check Digit	1225

Mod 10 Check Digit

The calculations for determining the Mod 10 Check Digit character are as follows:

1. Start at the first position and add the value of every other position together.
 $0 + 2 + 4 + 6 + 8 + 0 = 20$
2. The result of Step 1 is multiplied by 3.
 $20 \times 3 = 60$
3. Start at the second position and add the value of every other position together.
 $1 + 3 + 5 + 7 + 9 = 25$
4. The results of steps 2 and 3 are added together.
 $60 + 25 = 85$
5. The check character (12th character) is the smallest number which, when added to the result in step 4, produces a multiple of 10.
 $85 + X = 90$ (next higher multiple of 10)
 $X = 5$ Check Character

This bar code illustrates the above example. The digit on the right (5) is the check digit.



Mod 43 Check Digit

The calculations for determining the Mod 43 check Digit character are as follows:

Each character in the Code 39 character set has a specific value, as follows:

0=0	B=11	M=22	X=33
1=1	C=12	N=23	Y=34
2=2	D=13	O=24	Z=35
3=3	E=14	P=25	- =36
4=4	F=15	Q=26	. = 37
5=5	G=16	R=27	Space=38
6=6	H=17	S=28	\$=39
7=7	I=18	T=29	/=40
8=8	J=19	U=30	+ =41
9=9	K=20	V=31	%=42
A=10	L=21	W=32	



Example • Data string 2345ABCDE/

1. Add the sum of all the character values in the data string. Using the chart above, the sum of the character values is as follows:

$$1 + 2 + 3 + 4 + 5 + 10 + 11 + 12 + 13 + 14 + 40 = 115$$

2. Divide the total by 43. Keep track of the remainder.

$$115/43 = 2 \text{ Remainder is } 29$$

3. The “check digit” is the character that corresponds to the value of the remainder.

$$\text{Remainder} = 29$$

29 is the value for the letter T.

T is the check digit.

Below is a bar code that illustrates the example. The character on the right, T, is the check digit.



12345ABCDE/T

^F0125,100^B3N,Y,150,Y,N^FD12345ABCDE/^FS

Error Detection Protocol

This section explains the Zebra protocol that has been supplanted in TCP/IP based applications because of the error detection compatibility inherent in the TCP/IP protocol.

Contents

Introduction	1228
What is a Protocol?	1228
How Protocols Work	1228
Request Packet Formats from the Host Computer	1229
Header Block Fields.	1229
Data Block Fields.	1230
Response From the Zebra Printer	1231
Zebra Packet Response	1231
Header Block Fields.	1231
Data Block Fields.	1232
Disguising Control Code Characters	1233
Error Detection Protocol Application	1234
Error Conditions and System Faults	1234
How the Zebra Printer Processes a Request Packet.	1235
How the Zebra Printer Responds to Host Status	1236

Introduction

There are many instances when it is vitally important that the information sent to the Zebra printer is received completely Error-Free. ZPL II supports an error detection protocol called Zebra Packet Response Protocol to meet this need.



Note • This protocol only works when using serial interface. It does not function when using parallel interface.

What is a Protocol?

A protocol is a precisely defined set of rules. In the case of data communications, a Protocol defines how data is transmitted, received, and acknowledged between two devices.

The sole purpose of the Packet Response Protocol is to ensure that the information sent from a Host computer to the Zebra printer is received accurately. Remember, the protocol cannot insure the accuracy of the data that is actually sent from the Host computer. The commands and data needed to make a label (ZPL II Format) are encapsulated within the information sent from the Host computer.

How Protocols Work

The basic unit of data transfer in the Packet Response Protocol is called a “Transaction.” A Transaction is a two-way communication procedure that consists of information being sent from the Host computer to the Zebra printer, and the printer sending back a response to the Host computer. This response is an indication that the Zebra printer has either accepted or rejected the information sent from the Host computer.

Information is sent in the form of “Packets.” Packets sent from the Host computer are called Request Packets.

When a Request Packet is received, the Zebra printer analyzes the information in the Packet. If the Request Packet is accepted, the Zebra printer will send a positive response back to the Host computer. The Host computer can then send the next Request Packet. If the information is rejected, the Zebra printer will send a negative response back to the Host computer. The Host computer then sends the same Request Packet again.

The Zebra Packet Response Protocol can be used in both single-printer applications, where there is only one Zebra printer connected to the Host computer, and multi-drop systems in which several Zebra printers are connected to the same Host computer.

Request Packet Formats from the Host Computer

The first part of each data transfer Transaction is the sending of a Request Packet by the Host computer. The Request Packet contains a fixed length “Header” block and a variable length “Data” block. Each Packet sent from the Host computer to the Zebra printer must always use the following format.

The Request Packet Header Block is comprised of five fixed-length fields. The Request Packet Data Block is comprised of four fixed-length fields and one variable-length field. These fields are defined as follows.

Header Block					Data Block				
SOH	DST. Z-ID	SRC. Z-ID	TYPE	SEQ. #	STX	FORMAT	EXT	CRC	EOT
1	3	3	1	1	1	≤1024	1	2	1

Header Block Fields

- **SOH** (start of header character)
The Zebra printer interprets this character as the beginning of a new Request Packet. The ASCII Control Code character SOH (01H) is used as the Start of Header Character.
- **DST. Z-ID** (destination Zebra-ID)
This is the three-digit ASCII I.D. number used to identify which Zebra printer is to receive the Request Packet. The Zebra printer compares this number to the Network ID number assigned to it during Printer Configuration. The Zebra printer will act on the Request Packet only if these numbers match.
- **SRC. Z-ID** (source Zebra-ID)
This is a three-digit ASCII number used to identify the Host computer. This number is determined by the user.
- **TYPE** (packet type)
This field is used to define the type of Request Packet being sent by the Host. Only two characters are valid in this field:
 - ‘P’ indicates a Print Request Packet
 - ‘I’ indicates an Initialize Request Packet

Most of the Packets sent by the Host to the Zebra printer will be of the ‘P’ variety, requesting a label to be printed.

The ‘I’ character tells the Zebra printer to initialize the packet sequence numbering. It is required in the first packet of a new printing session, after starting up the Host computer or the Zebra printer.
- **SEQ. #** (the sequence number of the request packet)
This block contains a single digit number used to denote the current Transaction Number. The Host computer must increment this number by “1” for each new Request/Response Transaction pair, i.e. 0, 1, 2,..., 9. The numbers repeat after every 10 Transactions.

Data Block Fields

- **STX** (Start of Text)
The Zebra printer interprets this character as the beginning of the variable-length Data Format portion of the Request Packet. The ASCII Control Code character STX (02H) is used as the Start of Text Character.
- **DATA FORMAT** (Label Information)
A variable-length portion of the Request Packet that contains the complete or partial ZPL II label format, or partial data string (such as a downloaded graphic).
This field can contain from 0 to 1024 characters. If the Format of a label is longer than 1024 characters, the Data Format fields from consecutive packets will be concatenated together in the printer's Receive Data Buffer as if they were sent as one long direct transmission.
Special consideration has been given to the possible requirement to include ASCII Control Characters (values less than 20H) in the Data Format portion of a Request Packet. Characters such as EOT (04H), STX (02H), SOH (01H), and ETX (03H), are part of the Error Detection Protocol and could interrupt normal communication procedures if received at the wrong time.
- **ETX** (End of Text)
The Zebra printer interprets this character as the end of the variable length Data Format portion of the Request Packet. The ASCII Control Code character ETX (03H) is used as the End of Text Character.
- **CRC** (Cyclic Redundancy Check)
The CRC is a 2 character field. A Cyclic Redundancy Check is a type of error checking used to maintain the validity and integrity of the information transmitted between the Host computer and the Zebra printer. This Protocol uses the 16-bit CCITT method of producing a CRC.
The CRC is a two-byte value derived from the contents of the packet between, but not including, the SOH character and the CRC code itself. The Zebra printer will calculate a CRC of the Request Packet received and compare the value with the CRC Value in this field. The CRC of the Request Packet must match the CRC calculated by the Zebra printer in order for the Request Packet to be valid.
- **EOT** (End of Transmission)
The Zebra printer interprets this character as the end of the Request Packet. The ASCII Control Code character EOT (04H) is used as the End of Transmission Character.

Response From the Zebra Printer

When the Zebra printer receives the EOT character, it will begin acting on the Request Packet received. The printer will compare certain characters and numeric values within the received Request Packet and send a response back to the Host computer.

Zebra Packet Response

The Packet Response protocol provides the highest degree of error checking and is well suited to the Host-Multiple Printer application. The Response Packet from the Zebra printer will always use the following format.

The Request Packet Header Block is comprised of five fixed-length fields. The Request Packet Data Block is comprised of four fixed-length fields and one variable-length field. These fields are defined as follows.

Header Block					Data Block				
SOH	DST. Z-ID	SRC. Z-ID	TYPE	SEQ. #	STX	FORMAT	EXT	CRC	EOT
1	3	3	1	1	1	≤1024	1	2	1

Header Block Fields

- **SOH** (Start of Header Character)
The Zebra printer sends this character as the beginning of a new Response Packet. The ASCII Control Code character SOH (01H) is used as the Start of Header Character.
- **DST. Z-ID** (Destination Zebra-ID)
This is the same three-digit ASCII number used to identify the Host Computer that was contained in the SRC. Z-ID field of the Request Packet that initiated this Response Packet. The Host compares this number to its known value to insure it is the proper destination.
- **SRC. Z-ID** (Source Zebra-ID)
This is the three character ASCII Network I.D. of the Zebra printer that is sending the Response Packet.
- **TYPE** (Packet Type)
This block is used to define the type of Response Packet being sent to the Host. Only three characters are valid in this field.
 - ‘A’ This is a Positive Acknowledgment to the Host computer. It indicates that the Request Packet was received without a CRC error. The Host computer may send the next Request Packet.
 - ‘N’ This is the Negative Acknowledgment to the Host computer. It indicates that an error was detected in the packet sent from the Host computer. The Host computer must retransmit the same Request Packet again.
 - ‘S’ This character indicates that the Response Packet contains the Zebra Printer Status requested by a ~HS (Host Status) command received from the Host.

- **SEQ. #** (Used to denote the current message sequence number)
This number is identical to the message sequence number in the Request Packet. It denotes the message sequence number to which the Response Packet is replying.

Data Block Fields

- **STX** (Start of Text)
The Zebra printer sends this character as the beginning of the variable length Data Format portion of the Response Packet. The ASCII Control Code character STX (02H) is used as the Start of Text Character.
- **DATA FORMAT** (Label Information)
The 'variable length' portion of the Response Packet. If the Packet Type field in the Response Header contains an 'A' or an 'N', no data will appear in this field. If the Packet Type field contains an 'S', this field will contain the Printer Status Message.
- **ETX** (End of Text)
The Zebra printer sends this character as the end of the variable length Data Format portion of the Request Packet. The ASCII Control Code character ETX (03H) is used as the End of Text Character.
- **CRC** (Cyclic Redundancy Check)
This is the CRC of the Response Packet as calculated by the Zebra printer. This Cyclic Redundancy Check maintains the validity and integrity of the information transmitted between the Zebra printer and the Host computer.
This CRC is a two Byte value derived from the contents of the packet between, but not including, the SOH character and the CRC code itself. The Host computer will calculate a CRC of the received Response Packet and compare it to the CRC value in this field. The CRC of the Response Packet must match the CRC calculated by the Host computer in order for the Response Packet to be valid.
- **EOT** (End of Transmission)
The Zebra printer sends this character as the end of the Response Packet. The ASCII Control Code character EOT (04H) is used as the End of Transmission Character.

Disguising Control Code Characters

There may be occasions when ASCII Control Codes (00H - 19H) must be included as part of the Data Format block of a Request Packet. To eliminate any problems, these characters must be disguised so that the communication protocol does not act on them.

This procedure must be used to disguise each Control Code.

- A SUB (1AH) character must precede each Control Code placed in the Data Format block.
- The value of 40H must be added to the Hex value of the Control Code.
- The ASCII Character corresponding to the total value produced in step 2 must be entered in the Data Format right after the SUB character.

The Zebra printer automatically converts the modified control character back to its correct value by discarding the SUB (1AH) character and subtracting 40H from the next character.



Example • To include a DLE (10H) character in the Data Format block:

1. Enter a SUB (1AH) character into the Data Format.
2. Add 40H to the DLE value of 10H for a resulting value of 50H.
3. Enter the ASCII character “P” (50H) in the Data Format after the SUB character.



Note • This technique is counted as two characters of the 1024 allowed in the Data Format block.

Rules for Transactions

- Every Transaction is independent of every other Transaction and can only be initiated by the Host computer.
- A valid Response Packet must be received by the Host computer to complete a Transaction before the next Request Packet is sent.
- If an error is encountered during a Transaction, the entire Transaction (i.e., Request Packet and Response Packet) must be repeated.
- The Zebra printer does not provide for system time-outs and has no responsibility for insuring that its Response Packets are received by the Host computer.
- The Host computer must provide time-outs for all of the Transactions and insure that communication continues.
- If any part of a Transaction is lost or received incorrectly, it is the responsibility of the Host computer to retry the whole Transaction.

Error Detection Protocol Application

The following are the basic requirements for setting up the Zebra printer to use the Error Detection Protocol.

Activating the Protocol Protocol is a front panel selection, or can be done with the ZPL command `^SC`.

Setting Up Communications Insure that the Host computer and the Zebra printer are characterized with the same communication parameters; i.e., Parity, Baud Rate, etc. The communications must be set up for 8 data bits.

Setting the Printer ID Number The Protocol uses the printer's Network ID number to insure communication with the proper unit. The Network ID is programmed into the printer by sending the printer a `^NI` (Network ID Number) command or done through the front panel.

If there is only one printer connected to the Host computer, the Network ID number should be set to all zeros (default).

If there is more than one printer, such as in a broadcast or multi-drop environment, each printer should be assigned its own unique ID number. Printers in this environment, with an ID of all zeros, will receive ALL label formats regardless of the actual printer ID number in the DST. Z-ID block of the Request Packet.

Error Conditions and System Faults

Restarting a Transmission If a break in communication occurs, the Host must restart the transmission of the current label format with an Initialization Request Packet. The Zebra printer will not respond to Request Packets sent out of sequence. However, the Zebra printer will respond to an Initialization Request Packet and restart its internal counting with the sequence number of the Request Packet.

CRC Error Conditions and Responses A CRC error condition can be detected when the printer receives a Request Packet or when the Host computer receives a Response Packet. The following list defines these errors and how the Host computer should respond to them.

Error	Response
The CRC calculated by the Zebra printer does not match the one received as part of the Request Packet.	The Zebra printer will return a Negative Acknowledgment Response Packet. The Host computer should retry the same Transaction with the same Sequence Number.
The CRC calculated by the Host computer does not match the one received as part of the Response Packet.	The Host computer should retry the same Transaction with the same Sequence Number.

Time-Out Error Conditions and Responses

There are certain conditions at the Zebra printer that might cause the Host computer to time-out while processing a Transaction. The following list illustrates these conditions and how the Host computer should respond to them.

Error	Response
A Request Packet from the Host computer is not received by the Zebra printer.	The Host computer times out and resends the Request Packet of the same Transaction with the same Sequence Number.
A Request Packet from the Host computer is partially received by the Zebra printer.	The Host computer times out and resends the Request Packet of the same Transaction with the same Sequence Number.
A Response Packet from the Zebra printer is not received by the Host computer.	The Host computer times out and resends the Request Packet of the same Transaction with the same Sequence Number.
A Response Packet from the Zebra printer is partially received by the Host computer.	The Host computer times out and resends the Request Packet of the same Transaction with the same Sequence Number.

How the Zebra Printer Processes a Request Packet

The following describes the steps taken at the Zebra printer to process a Request Packet.

1. The Zebra printer looks for a SOH (Start of Header) character. As soon as it finds one, it places the SOH and all the data after it into its Receive Data Buffer. This process continues until the printer receives an EOT (End of Transmission) character.



Note • If a second SOH is received before an EOT is detected, the contents of the Receive Buffer will be discarded. All of the data after the second SOH will be placed in the Receive Data Buffer.

2. After detecting the EOT, the printer checks for the following:

- * The DST. Z-ID matches the printer's Network I.D.



Note • If the Network ID at the printer is all zeros, the printer will accept all Request Packets regardless of the DST. Z-ID received. If a Request Packet is received with the DST. Z-ID all zeros, it is accepted by all printers regardless of their Network ID setting.

- *The Data Format begins with STX and ends with ETX.

- *The Sequence Number has not been used before.

If the check is satisfactory, proceed to Step 3 on the following page.

If any part of the check is unsatisfactory, the printer discards the data in its Receive Data Buffer and waits for another SOH. No response is sent to the computer.

Exceptions

It is possible that the printer will send a response to the host that the host does not receive. Therefore, the host will send the same request packet to the printer again. If this happens, the printer will not use the data if it already used it before. However, the printer will send a response back to the host.

The printer calculates the CRC and compares it with the one received in the Request Packet. If the CRC is valid, the printer sends a Positive Response Packet to the Host computer. It then transfers the 'Variable Length' data from the Receive Buffer to its memory for processing. If the CRC does not match, and the printer is set up to return a Negative Response Packet, the following will take place:

1. The printer assumes that the DST. Z-ID, SRC. Z-ID, and Sequence Number are correct and that the error was in the variable data.
2. The same DST. Z-ID, printers SRC. Z-ID, and Sequence Number will be returned back to the host in the Negative Response Packet.
3. If the assumption in (a) is incorrect, the Host computer can time-out and retransmit the original Request Packet.

How the Zebra Printer Responds to Host Status

If a `~HS` (Host Status) command is received by the Zebra printer, the printer will send back an acknowledgment for the receipt of the packet. It then sends an additional packet that includes the Host Status information in the Variable Length portion of the packet.

ZB64 Encoding and Compression

This section describes the Base 64 MIME (ZB64) encoding and compression. This is the same type of MIME encoding that is used in e-mail.

For more information on ZB64 Encoding and Compression, please contact your Reseller or Zebra Representative.

Contents

Introduction to B64 and Z64.	1238
B64 and Z64 Encoding.	1240

Introduction to B64 and Z64

The first encoding, known as B64, encodes the data using the MIME Base64 scheme. Base64 is used to encode e-mail attachments and is specifically designed to address communications path limitations, such as control characters and 7-bit data links. It encodes the data using only the printable ASCII characters:

A B C D E F G H I J K L M N O P Q R S T U V W X Y Z
a b c d e f g h i j k l m n o p q r s t u v w x y z
0 1 2 3 4 5 6 7 8 9 + / =

With the use of ZPL, this has the added benefit of avoiding the caret (^) and tilde (~) characters. Base64 encodes six bits to the byte, for an expansion of 33 percent over the unenclosed data. This is much better than the 100 percent expansion given by the existing ASCII hexadecimal encoding.

The second encoding, known as Z64, first compresses the data using the LZ77 algorithm to reduce its size. (This algorithm is used by the PKWARE® compression program PKZIP™ and is integral to the PNG graphics format.) The compressed data is then encoded using the MIME Base64 scheme as described above.

A CRC is calculated across the Base64-encoded data. If the CRC-check fails or the download is aborted, the object can be invalidated by the printer.

The robust encodings can be piggybacked on the existing download commands with full backward compatibility. This is done by prefacing the new encodings with a header that uniquely identifies them. The download routines in the printer firmware can key-off the header to determine whether the data is in the old ASCII hexadecimal encoding or one of the new encodings. This allows existing downloadable objects to be used in their present format, while new objects can be created using the same download commands with the new encodings for increased integrity and reduced download times.

For easy reference, B64 and Z64 are referred to as ZB64. In any reference to the ZB64 encoding, assume that both Base64-only (B64) and LZ77/Base64 (Z64) encodings are accepted.



Example • The following is an example of an existing download command using the new encoding:

```
~DTARIAL,59494,:Z64:H4sICMB8+DMAC0FSSUFML1RURgDsmnd8VEW7x5+ZOedsyibZNNJhlyWhbE  
JIwYSwJDGNkmwghJIgJYEEhQIPsggKAjEAiIiVaSoIJYNBAKIGgGxUBVUUCGU0JQSC0WFnPvE+SF  
18+9H+8f973X+3Jm93umzzNznvnNSSFGRJ6ARAVZvXK7XDaxLyTiR5B7ontuZPQ824I5RKIa6ew+ab  
a8+pU1rVDZiciv
```

[multiple lines deleted]

```
/O6DU5wZ7ie2+g4xzDPwCpwm3nqW2GAPcdc1xF4fIP66jHjncmKvKzh/ZUNCx19/QQx2HXHYB4m/Pk  
QcdCdx2G7OYt+mszkMh4iZxoiFvkh89BFipo87kWD/Bf/d0cycAAEA:a1b2
```

The parameters are identical to the existing ~DT command:

Table 42 • ~DT Command Parameters

Parameter	Details
o = font name	<p><i>Accepted Values:</i> any valid TrueType name, up to 8 characters</p> <p><i>Default Value:</i> if a name is not specified, UNKNOWN is used</p> <p>In this example, Arial is the specified font.</p>
s = font size	<p><i>Accepted Values:</i> the number of memory bytes required to hold the Zebra-downloadable format of the font</p> <p><i>Default Value:</i> if an incorrect value or no value is entered, the command is ignored</p> <p>In this example, 59494 is the size.</p> <p>To maintain compatibility with the existing ASCII hexadecimal encoding, this field must contain the size of the un-enclosed and uncompressed object — the number of bytes that are finally placed into the printer’s memory, not the number of bytes downloaded.</p>
data = data string	<p><i>Accepted Values:</i> a string of ASCII hexadecimal values (two hexadecimal digits/byte). The total number of two-digit values must match parameter s.</p> <p><i>Default Value:</i> if no data is entered, the command is ignored</p> <p>Everything following the size field is data. The new encoding imposes a header with a unique signature. The new encoding must start with the characters :B64: (data encoded in Base-64 only) or :Z64: (data compressed with LZ77, then encoded in Base-64) followed by the encoded data.</p> <p>After the data is presented, another colon (:) and four hexadecimal digits comprise the CRC. The Base64 standard allows new-line characters (carriage returns and line feeds) to be inserted into the encoded data for clarity. These characters are ignored by the printer.</p>

When downloading graphics, the colon is used in the current ASCII hexadecimal encoding indicate “repeat the previous dot row.” Since this shorthand is invalid for the first character of data (no previous dot row has been downloaded), it is safe for the printer to detect the leading colon character as the lead-in for the new encodings.

B64 and Z64 Encoding

These download encodings, B64 and Z64, are created as drop-in replacements for the existing ASCII hexadecimal encoding.

B64 encoding do the following:

- Encode the compressed data using the MIME Base64 algorithm.
- Calculate a CRC across the encoded data.
- Add a unique header to differentiate the new format from the existing ASCII hex encoding.

Z64 encoding do the following:

- Compress the data using the LZ77 algorithm.
- Encode the compressed data using the MIME Base64 algorithm.
- Calculate a CRC across the encoded data.
- Add a unique header to differentiate the new format from the existing ASCII hexadecimal encoding.

The data field have this format:

:id:encoded_data:crc

This table identifies the parameters for this format:

Table 43 • Format Parameters

Parameter	Details
:id	the identifying string B64 or Z64
:iencoded_data	data to download, compressed with LZ77 (if the id parameter is set to Z64) and encoded with Base64.
:crc	four hexadecimal digits representing the CRC calculated over the :encoded_data field.

The printer calculates a CRC across the received data bytes and compare this to the CRC in the header. A CRC mismatch is treated as an aborted download.

The B64 and Z64 encodings can be used in place of the ASCII hexadecimal encoding in any download command. The commands are:

- ~DB – Download Bitmap Font
- ~DE – Download Encoding
- ~DG – Download Graphic
- ~DL – Download Unicode Bitmap Font
- ~DS – Download Scalable Font
- ~DT – Download TrueType Font
- ~DU – Download Unbounded TrueType Font
- ^GF – Graphic Field (with compression type set to “ASCII hex”)

The `~DB` (Download Bitmap Font) command can use the new encodings in place of the ASCII hexadecimal encoding in data sub-fields. Each character is encoded individually. However, for small amounts of data, the identifying B64 or Z64 header and trailing CRC may negate any gains made by using the new format.

For backward compatibility, the `^HG` (Host Graphic) command uses the ASCII hexadecimal encoding. It does not use the new encodings.

Field Interactions

This section provides you with examples that show how commands interact with various justification parameters. The examples are in charts for these orientations:

- Normal
- Rotated
- Bottom-up
- Inverted

These charts are designed so that you can identify the location of the field origin and interactions between the rotation, formatting and justification commands.

Normal Orientation

Table 44 shows you the various normal orientation outputs:

Table 44 • Normal Orientation Examples

	^FPH	^FPV	^FPR
^FO Left Justified	┌ABCDE	┌ A B C D E	EDCBA┌
^FT Left Justified	┌┐ABCDE	┌┐ A B C D E	EDCBA┌
^FO Right Justified	ABCDE┐	A┐ B C D E	EDCBA
^FT Right Justified	ABCDE┐┌	A┐┌ B C D E	EDCBA

Rotated Orientation

Table 45 shows you the various rotated orientation outputs:

Table 45 • Rotated Orientation Examples

	^FPH	^FPV	^FPR
^FO Left Justified	┌ ABCDE	A B C D └ E	EDCBA ┌
^FT Left Justified	┌ ABCDE	┌ A B C D E	EDCBA ┌
^FO Right Justified	└ ABCDE	└ A B C D E	EDCBA └
^FT Right Justified	ABCDE └	A B └ C D E	EDCBA └

Bottom Up Orientation

Table 46 shows you the various bottom up orientation outputs:

Table 46 • Bottom Orientation Examples

	^FPH	^FPV	^FPR
^FO Left Justified	ABCDE	A B C D E	EDCBA
^FT Left Justified	ABCDE	A B C D E	EDCBA
^FO Right Justified	ABCDE	A B C D E	EDCBA
^FT Right Justified	ABCDE	A B C D E	EDCBA

Inverted Orientation

Table 47 shows you the various inverted orientation outputs:

Table 47 • Inverted Orientation Examples

	^FPH	^FPV	^FPR
^FO Left Justified	ABCDEF	A B C D E	EDCBA
^FT Left Justified	ABCDEF	A B C D E	EDCBA
^FO Right Justified	ABCDEF	A B C D E	EDCBA
^FT Right Justified	ABCDEF	A B C D E	EDCBA

Real Time Clock

This appendix contains the information needed to install, program, and operate the Real Time Clock (RTC) option.

Overview

This hardware option is available as either a factory-installed or field-installable option in specific printer products manufactured and sold by Zebra Technologies Corporation.

The Real Time Clock option is currently available for following printers, and requires that the firmware version shown is installed on that printer.

Supported Zebra Printer and Print Engine Models		Requires this Firmware Version or Later
105SL printers that meet any one of the following criteria: <ul style="list-style-type: none"> if the printer was manufactured after April 2006 if the RTC Date and the RTC Time fields are printed on the configuration label if the RTC Date and the RTC Time appear on the LCD display 		60.13.0.13Z
DA402 & T402 printers		32.8.4
LP2844-Z, TPL2844-Z, and TPL3844-Z printers		45.10.x
PAX Series print engines	170PAX2 print engines	29.9.x or 31.9.x
	110PAX3 print engines using Standard Font	34.10.x
	110PAX3 print engines using TT Font	49.10.x
	116PAX3 print engines using TT Font	35.10.x
	170PAX3 print engines using Standard Font	37.10.x
	170PAX3 print engines using TT Font	38.10.x
	110PAX4 and 170PAX4 print engines	60.13.0.12
S4M printers (field-installable kit)		50.13.x
S600 printers		27.10.3
Xi Series printers	90XiII, 140XiII, 170XiII & 220XiII printers	18.9.x
	90XiIII, 96XiIII, 140XiIII, 170XiIII, and 220XiIII printers	33.10.0
	90XiIIIPlus, 96XiIIIPlus, 140XiIIIPlus, 170XiIIIPlus, and 220XiIIIPlus printers	60.13.0.12
Z4Mplus and Z6Mplus printers		60.13.0.12
ZM400/ZM600/RZ400/RZ600 printers		53.15.xZ

Control Panel Programming

New parameters for the Real Time Clock have been added to the Control Panel Configuration. These parameters are located immediately following the **FORMAT CONVERT** prompt. Refer to the printer/print engine *User Guide* for complete configuration information.

- X.9.x firmware added the parameters to *XiII* printers and 170PAX/170PAX2 print engines.
- X.10.x firmware added the parameters to *XiIII* printers and PAX3 print engines.
- X.13.x firmware added the parameters to *XiIIIPlus* printers, PAX4 print engines.
- X.13.0.13Z firmware added the parameters to 105SL printers.

Real Time Clock Parameters

The parameters listed on the following pages are added to the Control Panel Configuration prompts only when both the Real Time Clock hardware option and the appropriate version of firmware are installed:

- X.9.x or later firmware installed in the *XiII* series printers or the 170PAX/170PAX2 series print engines.
- X.10.x or later firmware installed in the *XiIII* series printers or the PAX3 series print engines.
- X.13.0.13Z or later firmware installed in the 105SL printers
- X.13.x or later firmware installed in the *XiIIIPlus* series printers, the PAX4 series print engines, or the S4M printers.

The RTC ZPL II commands apply to all printers/print engines with the Real Time Clock hardware option and proper firmware.

Idle Display

Selects the printer/print engine Idle Display format and the method of displaying the time/date information. This parameter also affects the Configuration Label printout and the **RTC DATE** and **RTC TIME** formats.

Selections

- FW VERSION
- MM/DD/YY 24HR
- MM/DD/YY 12HR
- DD/MM/YY 24HR
- DD/MM/YY 12HR

If FW VERSION is selected, the format on the Configuration Label and on the RTC DATE and RTC TIME parameters is MM/DD/YY 24HR.

RTC Date

Allows entry of the RTC date in the format selected by the **IDLE DISPLAY** parameter.



Note • The RTC parameters are password-protected. Refer to your printer’s user guide for specific instructions on accessing and modifying printer parameters.

Printer Model	Action
<i>PAX</i> Series print engines, <i>Xi</i> Series printers, and 105 <i>SL</i> printers	<ol style="list-style-type: none"> 1. Use the LEFT oval key to select the position to be adjusted 2. Then, use the RIGHT oval key to select the correct value for that position.
<i>Z4Mplus</i> and <i>Z6Mplus</i> printers	<ol style="list-style-type: none"> 1. Press SELECT to select the parameter. 2. Use the MINUS (-) key to select the position to be adjusted 3. Then, use the PLUS (+) key to select the correct value for that position. 4. Press SELECT to accept any changes and deselect the parameter.
S4M printer	<ol style="list-style-type: none"> 1. Press ENTER. The printer displays the current RTC date. 2. Modify the values as follows: <ul style="list-style-type: none"> • Press the right arrow to move to the next digit position. • To increase the value, press the up arrow. • To decrease the value, press the down arrow. 3. Press ENTER to accept the value shown.



Note • Invalid dates, such as 2/29/1999, may be entered, but will not be saved.

RTC Time

Allows entry of the RTC time in the format selected by the **IDLE DISPLAY** parameter.



Note • The RTC parameters are password-protected. Refer to your printer's user guide for specific instructions on accessing and modifying printer parameters.

Printer Model	Action
<i>PAX</i> Series print engines, <i>Xi</i> Series printers, and <i>105SL</i> printers	<ol style="list-style-type: none"> 1. Use the LEFT oval key to select the position to be adjusted 2. Use the RIGHT oval key to select the correct value for that position.
<i>Z4Mplus</i> and <i>Z6Mplus</i> printers	<ol style="list-style-type: none"> 1. Press SELECT to select the parameter. 2. Use the MINUS (-) key to select the position to be adjusted. 3. Use the PLUS (+) key to select the correct value for that position. 4. Press SELECT to accept any changes and deselect the parameter.
S4M printer	<ol style="list-style-type: none"> 1. Press ENTER. The printer displays the current RTC date. 2. Modify the values as follows: <ul style="list-style-type: none"> • Press the right arrow to move to the next digit position. • To increase the value, press the up arrow. • To decrease the value, press the down arrow. 3. Press ENTER to accept the value shown.

RTC General Information

The Real Time Clock commands are only applicable if the Real Time Clock option is installed in the printer. For those printers with an LCD control panel display, additional control panel configuration parameters are also included.

The ZPL II Field Clock **^FC** command is used to specify the clock-indicator character for the primary, secondary, and third clocks. This command must be included within each label field command string whenever the date or time clock values are required within the field. No date or time clock information can be printed in a label field unless this command is included. The **^FC** command can now be combined with the **^SN** command in V60.13.0.10 and later.

A clock-indicator can be any printable character except the ZPL II Format Prefix, Control Prefix, or Delimiter characters. The default value for the primary clock-indicator is the percent sign **%**. The secondary and third clock-indicators have no defaults and must be specified in order for that clock to be used.

The Field Data **^FD** command has been expanded to recognize the clock-indicators and associated command characters, and to replace them during the printing process with the corresponding time or date parameter. For example, if the primary clock-indicator is the percent sign **%**, then during printing, the character sequence **%H** in the **^FD** statement would be replaced by the 2-digit current hour.



Note • If the Real Time Clock is not installed, or the **^FC** command has not preceded the **^FD** statement, no replacement would occur. In this case, the characters **%H** would print as text on the label.

The name of the day of the week, the name of the month, and the AM or PM designation can also be inserted in place of a specific clock-indicator/command character sequence. See [Table 48](#) for the list of command characters and their functions.

Table 48 • Command Characters

Command Character	Function
%a	is replaced by the abbreviated weekday name
%A	is replaced by the weekday name
%b	is replaced by the abbreviated month name
%B	is replaced by the month name
%d	is replaced by the day of the month number, 01 to 31
%H	is replaced by the hour of the day (military), 00 to 23
%I	is replaced by the hour of the day (civilian), 01 to 12
%j	is replaced by the day of the year, 001 to 366
%m	is replaced by the month number, 01 to 12
%M	is replaced by the minute, 00 to 59
%p	is replaced by the AM or PM designation
%S	is replaced by the seconds, 00 to 59
%U	is replaced by the week# of the year, 00 to 53, Sunday is 1st day*
%W	is replaced by the week# of the year, 00 to 53, Monday is 1st day**
%w	is replaced by the day# of the week, 00 (Sunday) to 06 (Saturday)
%y	is replaced by the 2 digits of the year, 00 to 99
%Y	is replaced by the full 4 digit year number—where% is the specified clock-indicator character

*. %U establishes Sunday as the first day of the year.

**.%W establishes Monday as the first day of the year.

The Set Offset **^SO** command permits the printing of specific times and dates relative to the primary clock. The secondary (or third) clock is enabled when secondary (or third) offsets are entered using this command. The secondary (or third) clock time and date are determined by adding the offsets to the current clock reading.

One **^SO** command is required to set the secondary offset; an additional **^SO** command is required for a third offset. The offsets remain until changed or until the printer is either powered down or reset.



Note • Only dates from January 1, 1998 to December 31, 2097 are supported. Setting the offsets to values that result in dates outside this range is not recommended and may have unexpected results.

The Set Mode/Language (see [^SL on page 343](#)) command is used to select the language the days of the week and the months are printed in. This command also sets the printing mode, which can be **S** for START TIME, **T** for TIME NOW, or a Numeric Value for the time accuracy. In START TIME mode, the time printed on the label is the time that is read from the Real Time Clock when the label formatting begins (when the **^XA** command is received by the printer). In TIME NOW mode, the time printed on the label is the time that is read from the Real Time Clock when the label is placed in the queue to be printed. In Numeric Value mode, a time accuracy tolerance can be specified.

First Day of the Week Affects Calendar Week

The **%U** and **%W** commands set the first day of the week. The week numbering starts at the beginning of the year with Week 01 representing the **first full week** of the year. Any day(s) before that established first day of the week are part of the Week 00. The following examples show how setting different days as the first day of the week affect the calendar week.



Important • The **%U** and **%W** commands determine the numbering for all weeks in the year.



Example • January, 2005 with Week 00

Set Sunday as the first day of the week using the **%U** command. In this example, notice that Saturday, January 1st is Week 00 and Sunday, January 2nd begins Week 01.

	Sun	Mon	Tue	Wed	Thu	Fri	Sat	
							1	← Week 00
First Day of the Week →	2	3	4	5	6	7	8	← Week 01
	9	10	11	12	13	14	15	
	16	17	18	19	20	21	22	
	23	24	25	26	27	28	29	
	30	31						

→ **Example • January, 2005 with Week 00**

Set Monday as the first day of the week using the %W command. In this example, notice that Saturday, January 1st **and** Sunday, January 2nd are Week 00 and Monday, January 3rd begins Week 01.

Mon	Tue	Wed	Thu	Fri	Sat	Sun
					1	2
3	4	5	6	7	8	9
10	11	12	13	14	15	16
17	18	19	20	21	22	23
24	25	26	27	28	29	30
31						

First Day of the Week → (points to Mon)

← Week 00 (points to Sat 1, Sun 2)

← Week 01 (points to Mon 3)

→ **Example • January, 2006 without Week 00**

Set Sunday as the first day of the week using the %U command. Since 2006 begins on a Sunday, there is no Week 00 in this example.

Sun	Mon	Tue	Wed	Thu	Fri	Sat
No Week 00						
1	2	3	4	5	6	7
8	9	10	11	12	13	14
15	16	17	18	19	20	21
22	23	24	25	26	27	28
29	30	31				

First Day of the Week → (points to Sun)

← Week 01 (points to Sun 1)

→ **Example • January, 2006 with Week 00**

Set Monday as the first day of the week using the %W command. In this example, Saturday, January 1st is Week 00 and Sunday, January 2nd begins Week 01.

Mon	Tue	Wed	Thu	Fri	Sat	Sun
						1
2	3	4	5	6	7	8
9	10	11	12	13	14	15
16	17	18	19	20	21	22
23	24	25	26	27	28	29
30	31					

Annotations: An arrow points to the 'Mon' header with the text "First Day of the Week". An arrow points to the 'Sun' cell containing '1' with the text "Week 00". An arrow points to the 'Sun' cell containing '8' with the text "Week 01".

Time and Date Precision

As of V60.13.0.1 firmware, the ^CO command is now ignored. While the S4M printer has a lower firmware version number (V50.x), its firmware was recently released and follows the rule to ignore the ^CO command.

The time and date placed in a label field is determined at the time the label bitmap is created by the printer (start time mode). If a batch of labels is formatted, the date and time will be the same for all labels in the batch. If the printer is paused during the printing process and remains in that state for a period of time, when printing resumes, the time and date will still be the same as when the batch was first started.

If more precise time and date stamps are required on versions prior to V60, follow the process below. For versions after V60, use the Numeric Value mode as shown in ^SL on page 343.

Cycle the printer/print engine power Off (O) and On (I) to clear the memory before performing the steps below.

1. Print a Memory Usage Label (^XA^WD*:*. *^XZ) and note the following value: Available RAM (in BYTES) (A) _____
2. Print a Configuration Label and note these values:
 - Printer "Print Width" (in DOTS) (B) _____
 - (NOT the Label Width)
 - Label Length (in DOTS) (C) _____
3. Determine the desired maximum number of queued labels with the same Time and Date value. (D) _____



Note • Increasing the number of queued labels will improve throughput performance, but Real Time Clock values will be less accurate. Two is usually a good compromise.

4. Substitute the values for B through D from the previous page into the following formula:
 The “label queue” memory required (in BYTES) (E) _____
 $(B \times C \times D)/8 =$
5. Substitute the values for A and E into the following formula:
 The ^CO command memory required (in KBYTES) (F) _____
 $(A-E)/1024-5=$



Note • If the value of (F) is less than zero, then no ^CO command is needed. If the value of (F) is greater than zero, use the integer portion in the ^CO command.



Example •

Available RAM (A) = 71478 BYTES
 Print Width (B) = 832 DOTS
 Label Length (C) = 1000 DOTS
 Max Labels Queued (D) = 2

Then —
 The label queue memory required (E) =
 $(B \times C \times D)/8 = 208000$ BYTES

And —
 The ^CO command memory required (F) =
 $(71478-208000)/1024-5=489.87$ KBYTES

Therefore, the correct ^CO command string to add to the label format would be:

^XA^COY,489^XZ

This command string will cause 489 KBYTES to be set aside as Font Memory and make it unavailable as label format memory. The memory remaining will only allow two labels to be formatted at one time, and the time and date will be more precise for those two labels.



Note • For the 170PAX2 print engine, you must disable the Reprint Function for the Time Now Mode to function properly.

ZPL II Samples

The ZPL II scripts shown on this page establish the initial settings for the date and time clock. The script below then references these settings to provide the output shown in [Figure 8 on page 1261](#).

Setting the date and time for the Real Time Clock only needs to be done once. The date and time are maintained by an on-board battery when the printer is reset or the printer is turned Off (O).

To set the date and time to April 23, 2005 at 2:30pm, the following command string should be sent to the printer:

```
^XA
  ^ST04,23,2005,02,30,0,P^FS
^XZ
```

To initialize the Real Time Clock and set up two offset values (offset #2 set to 3 months and 1 hour in the future, offset #3 set to 1 year in the past), the following command sequence should be sent to the printer:

```
^XA
  ^SL
  ^S02,3,0,0,1,0,0^FS
  ^S03,0,0,-1,0,0,0^FS
^XZ
```

The above ZPL II scripts initialize the RTC date and time and must be sent to a printer to provide proper date and time parameters for the ZPL II script below.

The following ZPL II script illustrates the various methods of printing the date and time initialized in the script above within separate fields on continuous media. [Figure 8 on page 1261](#) illustrates the printout of this script on a label.

For the below example, the **^FC** command delimiters are:

- % Primary clock indicator
- { Secondary clock indicator
- # Third clock indicator

```
^XA
  ^LL175
  ^F010,025^AD^FC%,{,#^FD1: Mil: %H:%M:%S Civ: %I:%M:%S %p^FS
  ^F010,050^AD^FC%,{,#^FD2: Mil: {H:{M:{S Civ: {I:{M:{S {p^FS
  ^F010,075^AD^FC%,{,#^FD3: Mil: #H:#M:#S Civ: #I:#M:#S #p^FS
  ^F010,100^AD^FC%,{,#^FD1: On %A, %B %d
  , %Y (%a, %m/%d/%y, %d %b %Y).^FS
  ^F010,125^AD^FC%,{,#^FD2: On {A, {B {d, {Y (
  {a, {m/{d/{y, {d {b {Y).^FS
  ^F010,150^AD^FC%,{,#^FD3: On #A, #B #d, #Y (
  #a, #m/#d/#y, #d #b #Y).^FS
^XZ
```

Figure 8 • Printed Result of the Above ZPL II Script

- 1: Mil: 14:30:00 Civ: 02:30:00 PM
- 2: Mil: 15:30:00 Civ: 03:30:00 PM
- 3: Mil: 14:30:00 Civ: 02:30:00 PM
- 1: On Wed, April 23, 2005 (Fri, 04/23/05, 23 Apr 2005)
- 2: On Saturday, July 23, 2005 (Sat, 07/23/05, 23 Jul 2005)
- 3: On Friday, April 23, 2004 (Fri, 04/23/04, 23 Apr 2004)

The following are examples of the time stamp using the **^SL1** and **^SL5** at 2 ips and 10 ips for the Enhanced Real Time Clock (V60.13.0.10 and later).



Note • They show the variation of time due to print speed and label complexity.

```

^XA
  ^SL1^FS
  ^F0187,184^A0N,101,121^FC%^FD%H:%M:%S^FS
  ^PQ10
^XZ
  
```

Figure 9 • Example of ^SL1, 2 ips and 10 ips

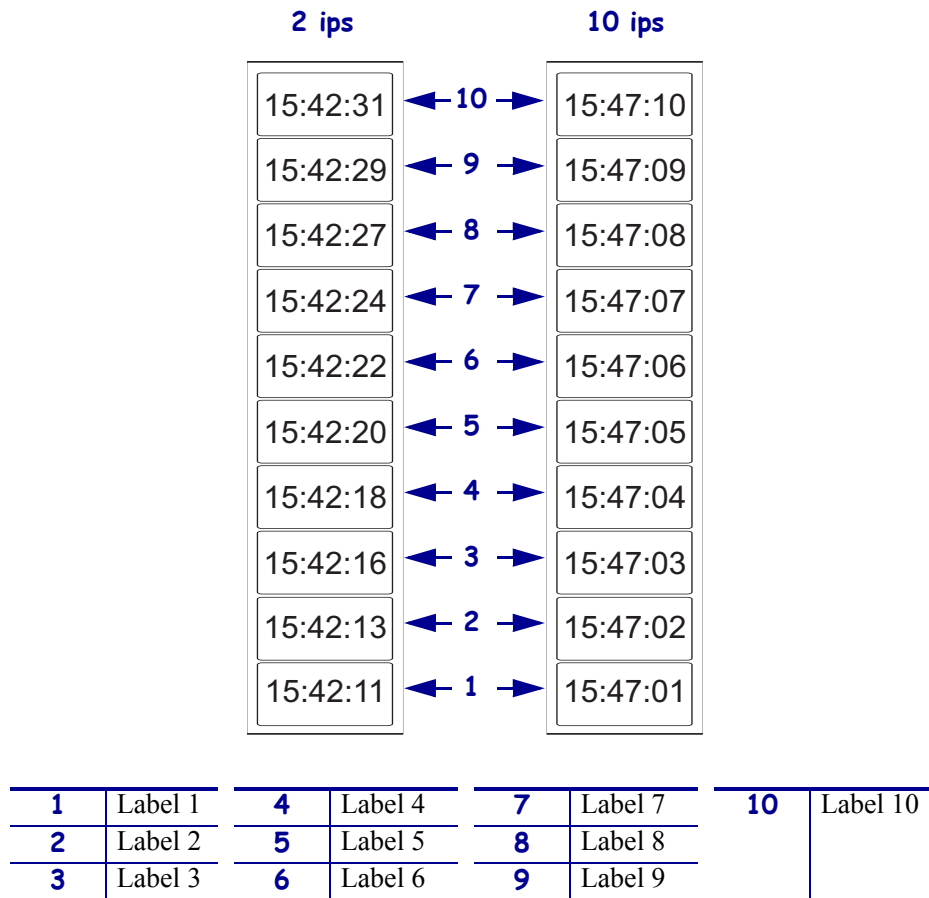

```

^XA
  ^SL5^FS
    ^F0187,184^A0N,101,121^FC%^FD%H:%M:%S^FS
  ^PQ10
^XZ
  
```

Figure 10 • Example of ^SL5, 2 ips and 10 ips

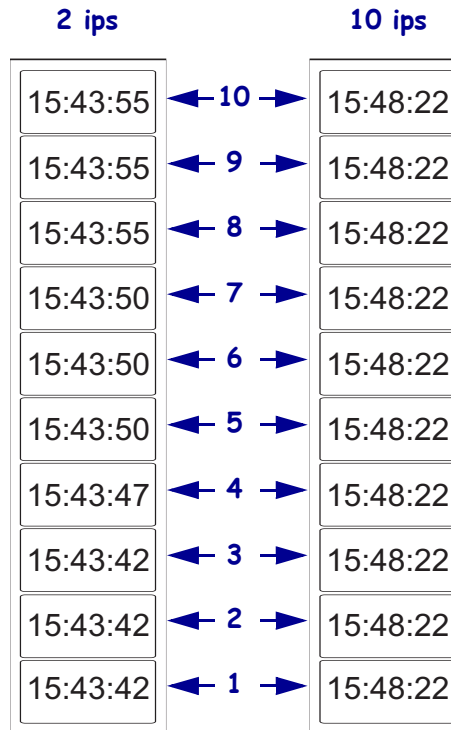

1	Label 1	6	Label 6
2	Label 2	7	Label 7
3	Label 3	8	Label 8
4	Label 4	9	Label 9
5	Label 5	10	Label 10

ZBI Character Set

This section provides you with the set of characters that are supported on the front panel of the following Zebra printers with ZBI 2.0: *XiIIIPlus*, 105SL, Z4M/Z6M, ZM400/ZM600, RZ400/RZ600, PAX4 and S4M when V60.16.0Z or V53.16.0Z, or later firmware are loaded. These characters can be used in ZBI programs to display content on the LCD.

Character Set

These are the supported characters for these Zebra printers:

- *XiIIIPlus*
- 105SL
- Z4M/Z6M
- PAX4
- S4M:

Char. code

xxxx0000	0	0	0	0	0	0	0	1	1	1	1	1	1
xxxx0001	0	0	0	1	1	1	1	0	0	1	1	1	1
xxxx0010	0	1	1	0	0	1	1	1	1	0	0	1	1
xxxx0011	0	0	1	0	1	0	1	0	1	0	1	0	1
xxxx0100	!	1	A	Q	a	q	。	ア	チ	△	ä	q	
xxxx0101	"	2	B	R	b	r	「	イ	ツ	×	β	θ	
xxxx0110	#	3	C	S	c	s	」	ウ	テ	モ	ε	ω	
xxxx0111	\$	4	D	T	d	t	、	エ	ト	†	μ	Ω	
xxxx1000	%	5	E	U	e	u	・	オ	ナ	1	ε	ü	
xxxx1001	&	6	F	V	f	v	ヲ	カ	ニ	ヨ	ρ	Σ	
xxxx1010	'	7	G	W	g	w	ア	キ	ヌ	ラ	q	π	
xxxx1011	(8	H	X	h	x	イ	ク	ネ	リ	」	又	
xxxx1100)	9	I	Y	i	y	ウ	ケ	ル	」	U		
xxxx1101	*	:	J	Z	j	z	エ	コ	ハ	レ	i	〒	
xxxx1110	+	:	K	[k	[オ	サ	ヒ	ロ	*	〒	
xxxx1111	,	<	L	¥	1	1	ハ	シ	フ	ワ	Φ	円	
xxxx1100	-	=	M]	m]	ユ	ズ	ハ	ン	モ	÷	
xxxx1110	.	>	N	^	n	^	ヨ	セ	ホ	ッ	ん		
xxxx1111	/	?	O	_	o	_	ツ	ッ	マ	°	ö	■	

These are the supported characters for these Zebra printers:

- ZM400/ZM600
- RZ400/RZ600
- Xi4
- RXi4

space 0020	" 0022	% 0025	& 0026	(0028) 0029	+ 002B	- 002D	. 002E	/ 002F
0 0030	1 0031	2 0032	3 0033	4 0034	6 0035	7 0037	8 0038	9 0039	: 003A
> 003E	? 003F	A 0041	B 0042	C 0043	D 0044	E 0045	F 0046	G 0047	H 0048
I 0049	J 004A	K 004B	L 004C	M 004D	N 004E	O 004F	P 0050	Q 0051	R 0052
S 0053	T 0054	U 0055	V 0056	W 0057	X 0058	Y 0059	Z 005A	_ 005F	



Notes • _____

SGD Command Support

This appendix provides you with details identifying which SGD commands can be used with different printers and firmware versions.

Printer and Firmware Compatibility

This section provides supported printer models and minimum firmware versions for all SGD commands. In order to set and get configurations, the SGD commands can be used through the Ethernet, serial, parallel, and USB interfaces.



Note • The printer responds with the printer setting of "?" if the printer setting:

- does not exist
- has not been configured yet

If you have ...	Then...
<ul style="list-style-type: none"> • 105SL • PAX4 • S4M • Xi4 • XiIIIPlus 	<ul style="list-style-type: none"> • Z4MPlus/Z6MPlus • ZM400/ZM600 • ZT200 Series • ZE500 Series <p>Go to Table 49, Table Top and Print Engine SGD Firmware Compatibility on page 1269.</p>
<ul style="list-style-type: none"> • ZD500R • HC100 • KR403 • LP2824 Plus • TLP2824 Plus 	<ul style="list-style-type: none"> • G-Series • GT800 • GC420d • GC420t • GK800 • GK888 <p>Go to Table 50, Desktop and Kiosk SGD Firmware Compatibility on page 1281.</p>
<ul style="list-style-type: none"> • R110PAX4 • R110Xi (UHF) • R110Xi HF • R170Xi 	<ul style="list-style-type: none"> • R4Mplus • RXi4 • RZ400/RZ600 <p>Go to Table 51, RFID Printer SGD Firmware Compatibility on page 1301.</p>

Standard Table Top Printers and Print Engines



Important • All the firmware versions noted in [Table 49](#) refer to the minimum firmware version required. For Desktop and Kiosk printers see [Table 50](#). For RFID printer support, see [Table 51](#).

Table 49 • Table Top and Print Engine SGD Firmware Compatibility

SGD Commands	ZE500 Series	ZT200 Series	XiIIIPlus 105SL, PAX4 Z4MPlus Z6MPlus	S4M	ZM400 ZM600	Xi4
appl.bootblock	V53.17.16Z	V72.18.2Z	V60.15.8Z	V53.15.5Z	V53.15.5Z	V53.17.1Z
appl.name	V53.17.16Z	V72.18.2Z	V60.15.8Z	V53.15.5Z	V53.15.5Z	V53.17.1Z
appl.option_board_version	V53.17.16Z	V72.18.2Z	V60.16.4Z	V53.16.4Z	V53.16.4Z	V53.17.1Z
bluetooth.address	—	V72.18.2Z	—	—	—	—
bluetooth.afh_map	—	V72.18.2Z	—	—	—	—
bluetooth.afh_map_curr	—	V72.18.2Z	—	—	—	—
bluetooth.afh_mode	—	V72.18.2Z	—	—	—	—
bluetooth.authentication	—	V72.18.2Z	—	—	—	—
bluetooth.bluetooth_pin	—	V72.18.2Z	—	—	—	—
bluetooth.date	—	V72.18.2Z	—	—	—	—
bluetooth.discoverable	—	V72.18.2Z	—	—	—	—
bluetooth.enable	—	V72.18.2Z	—	—	—	—
bluetooth.friendly_name	—	V72.18.2Z	—	—	—	—
bluetooth.local_name	—	V72.18.2Z	—	—	—	—
bluetooth.radio_auto_baud	—	V72.18.2Z	—	—	—	—
bluetooth.radio_version	—	V72.18.2Z	—	—	—	—
bluetooth.short_address	—	V72.18.2Z	—	—	—	—
bluetooth.version	—	V72.18.2Z	—	—	—	—
card.inserted	V53.17.16Z	V72.18.2Z	V60.15.2Z	V50.15.2Z	V53.15.5Z	V53.17.1Z
card.mac_addr	V53.17.16Z	V72.18.2Z	V60.15.2Z	V50.15.2Z	V53.15.5Z	V53.17.1Z
CISDFCRC16	V53.17.16Z	V72.18.2Z	V60.16.4Z	V53.16.4Z	V53.16.4Z	V53.17.1Z
comm.baud	V53.17.2Z	V72.18.2Z	V60.15.0	V50.15.0	V53.15.5Z	V53.17.2Z
comm.halt	—	V72.18.2Z	—	—	—	—
comm.parity	V53.17.2Z	V72.18.2Z	V60.15.1	V50.15.0	V53.15.5Z	V53.17.2Z
comm.pnp_option	V53.17.2Z	V72.18.2Z	V60.15.0	V50.15.0	V53.15.5Z	V53.17.2Z
comm.stop_bits	V53.17.2Z	V72.18.2Z	V60.15.2	V50.15.0	V53.15.5Z	V53.17.2Z
comm.type	—	V72.18.2Z	—	—	—	—
cutter.clean_cutter	—	V72.18.2Z	—	—	—	—
device.command_override.active	—	—	—	—	—	—
device.command_override.clear	—	—	—	—	—	—
device.command_override.list	—	—	—	—	—	—
device.cutter_installed	—	—	—	—	—	—

* On these printers with ZebraNet™ 10/100 Internal Print Server.

** On these printers with ZebraNet™ 10/100 External Print Server, firmware version 1.1.5

Table 49 • Table Top and Print Engine SGD Firmware Compatibility (Continued)

SGD Commands	ZE500 Series	ZT200 Series	XIIIPlus 105SL, PAX4 Z4MPlus Z6MPlus	S4M	ZM400 ZM600	Xi4
device.download_connection_timeout	V53.17.16Z	V72.18.2Z	V60.16.4Z	V53.16.4Z	V53.16.4Z	V53.17.1Z
device.epi_legacy_mode	—	V72.18.2Z	—	—	—	—
device.friendly_name	V53.17.16Z	V72.18.2Z	V60.16.4Z	V53.16.4Z	V53.16.4Z	V53.17.1Z
device.frontpanel.feedenabled	—	V72.18.2Z	—	—	—	—
device.frontpanel.key_press	V53.17.16Z	V72.18.2Z	V60.16.2Z	V53.16.2Z	V53.16.2Z	V53.17.1Z
device.frontpanel.line1	V53.17.16Z	V72.18.2Z	V60.16.2Z	V53.16.2Z	V53.16.2Z	V53.17.1Z
device.frontpanel.line2	V53.17.16Z	V72.18.2Z	V60.16.2Z	V53.16.2Z	V53.16.2Z	V53.17.1Z
device.frontpanel.xml	V53.17.16Z	V72.18.2Z	V60.16.2Z	V53.16.2Z	V53.16.2Z	V53.17.1Z
device.host_identification	—	V72.18.2Z	—	—	—	—
device.host_status	—	V72.18.2Z	—	—	—	—
device.jobs_print	V53.17.16Z	V72.18.2Z	V60.16.4Z	V53.16.4Z	V53.16.4Z	V53.17.1Z
device.languages	V53.17.16Z	V72.18.2Z	V60.15.8Z	V53.15.5Z	V53.15.5Z	V53.17.1Z
device.ltu_installed	—	V72.18.2Z	—	—	—	—
device.orientation	—	V72.18.2Z	—	—	—	—
device.pause	—	V72.18.2Z	—	—	—	—
device.pnp_option	—	V72.18.2Z	—	—	—	—
device.position.accuracy	—	V72.19.6Z	—	—	—	—
device.position.altitude	—	V72.19.6Z	—	—	—	—
device.position.latitude	—	V72.19.6Z	—	—	—	—
device.position.longitude	—	V72.19.6Z	—	—	—	—
device.print_reprogram_2key	—	V72.18.2Z	—	—	—	—
device.reset	V53.17.16Z	V72.18.2Z	V60.16.4Z	V53.16.4Z	V53.16.4Z	V53.17.1Z
device.restore_defaults	V53.17.16Z	V72.18.2Z	V60.16.4Z	V53.16.4Z	V53.16.4Z	V53.17.1Z
device.super_host_status	—	V72.18.2Z	—	—	—	—
device.unique_id	V53.17.16Z	V72.18.2Z	V60.16.2Z	V53.16.2Z	V53.16.2Z	V53.17.1Z
device.unpause	—	V72.18.2Z	—	—	—	—
device.uptime	V53.17.16Z	V72.18.2Z	V60.16.4Z	V53.16.4Z	V53.16.4Z	V53.17.1Z
device.user_p1	V53.17.16Z	V72.18.2Z	V60.16.4Z	V53.16.4Z	V53.16.4Z	V53.17.1Z
device.user_p2	V53.17.16Z	V72.18.2Z	V60.16.4Z	V53.16.4Z	V53.16.4Z	V53.17.1Z
device.xml.enable	V53.17.16Z	V72.18.2Z	V60.15.8Z	V53.15.8Z	V53.15.8Z	V53.17.1Z
display.backlight	—	V72.18.2Z	—	—	—	—
display.backlight_on_time	—	V72.18.2Z	—	—	—	—
display.language	—	V72.18.2Z	—	—	—	—
display.load_card	—	V72.18.2Z	—	—	—	—
display.text	V53.17.16Z	V72.18.2Z	V60.16.4Z	V53.16.4Z	V53.16.4Z	V53.17.1Z
external_wired.check	V53.17.16Z	V72.18.2Z	V60.16.4Z	V53.16.4Z	V53.16.4Z	V53.17.1Z
external_wired.ip.addr	V53.17.16Z	V72.18.2Z	V60.15.8Z	**V53.15.5Z	**V53.15.5Z	V53.17.1Z

* On these printers with ZebraNet™ 10/100 Internal Print Server.

** On these printers with ZebraNet™ 10/100 External Print Server, firmware version 1.1.5

Table 49 • Table Top and Print Engine SGD Firmware Compatibility (Continued)

SGD Commands	ZE500 Series	ZT200 Series	XIIIPlus 105SL, PAX4 Z4MPlus Z6MPlus	S4M	ZM400 ZM600	Xi4
external_wired.ip.arp_interval	V53.17.16Z	V72.18.2Z	V60.15.8Z	V53.15.5Z	V53.15.5Z	V53.17.1Z
external_wired.ip.default_addr_enable	V53.17.16Z	V72.18.2Z	V60.15.8Z	V53.15.5Z	V53.15.5Z	V53.17.1Z
external_wired.ip.dhcp.cid_all	V53.17.16Z	V72.18.2Z	V60.15.8Z	**V53.15.5Z	**V53.15.5Z	V53.17.1Z
external_wired.ip.dhcp.cid_enable	V53.17.16Z	V72.18.2Z	V60.15.8Z	**V53.15.5Z	**V53.15.5Z	V53.17.1Z
external_wired.ip.dhcp.cid_prefix	V53.17.16Z	V72.18.2Z	V60.15.8Z	**V53.15.5Z	**V53.15.5Z	V53.17.1Z
external_wired.ip.dhcp.cid_suffix	V53.17.16Z	V72.18.2Z	V60.15.8Z	**V53.15.5Z	**V53.15.5Z	V53.17.1Z
external_wired.ip.dhcp.cid_type	V53.17.16Z	V72.18.2Z	V60.15.8Z	V53.15.5Z	**V53.15.5Z	V53.17.1Z
external_wired.ip.gateway	V53.17.16Z	V72.18.2Z	V60.15.8Z	V53.15.5Z	V53.15.5Z	V53.17.1Z
external_wired.ip.netmask	V53.17.16Z	V72.18.2Z	V60.15.8Z	V53.15.5Z	V53.15.5Z	V53.17.1Z
external_wired.ip.port	V53.17.16Z	V72.18.2Z	V60.15.8Z	V53.15.5Z	V53.15.5Z	V53.17.1Z
external_wired.ip.protocol	V53.17.16Z	V72.18.2Z	V60.15.8Z	V53.15.5Z	V53.15.5Z	V53.17.1Z
external_wired.ip.timeout.enable	V53.17.16Z	V72.18.2Z	V60.15.8Z	V53.15.5Z	V53.15.5Z	V53.17.1Z
external_wired.ip.timeout.value	V53.17.16Z	V72.18.2Z	V60.15.8Z	V53.15.5Z	V53.15.5Z	V53.17.1Z
external_wired.ip.v6.addr	V53.17.16Z	V72.18.2Z	V60.16.5Z	v53.16.5Z	v53.16.5Z	V53.17.1Z
external_wired.ip.v6.gateway	V53.17.16Z	V72.18.2Z	V60.16.5Z	v53.16.5Z	v53.16.5Z	V53.17.1Z
external_wired.ip.v6.prefix_length	V53.17.16Z	V72.18.2Z	V60.16.5Z	v53.16.5Z	v53.16.5Z	V53.17.1Z
external_wired.mac_addr	V53.17.16Z	V72.18.2Z	V60.15.8Z	V53.15.5Z	V53.15.5Z	V53.17.1Z
external_wired.mac_raw	V53.17.16Z	V72.18.2Z	V60.16.4Z	V53.16.4Z	V53.16.4Z	V53.17.1Z
ezpl.head_close_action	—	V72.18.2Z	—	—	—	—
ezpl.label_length_max	—	V72.18.2Z	—	—	—	—
ezpl.label_sensor	—	V72.18.2Z	—	—	—	—
ezpl.manual_calibration	—	V72.18.2Z	—	—	—	—
ezpl.media_type	—	V72.18.2Z	—	—	—	—
ezpl.power_up_action	—	V72.18.2Z	—	—	—	—
ezpl.print_method	—	V72.18.2Z	—	—	—	—
ezpl.print_width	—	V72.18.2Z	—	—	—	—
ezpl.reprint_mode	—	V72.18.2Z	—	—	—	—
ezpl.take_label	—	V72.18.2Z	—	—	—	—
ezpl.tear_off	—	V72.18.2Z	—	—	—	—
file.delete	V53.17.16Z	V72.18.2Z	V60.16.4Z	V53.16.4Z	V53.16.4Z	V53.17.1Z
file.dir	V53.17.16Z	V72.18.2Z	V60.16.4Z	V53.16.4Z	V53.16.4Z	V53.17.1Z
file.dir_format	—	V72.18.2Z	—	—	—	—
file.run	V53.17.16Z	V72.18.2Z	V60.16.4Z	V53.16.4Z	V53.16.4Z	V53.17.1Z
file.type	V53.17.16Z	V72.18.2Z	V60.16.4Z	V53.16.4Z	V53.16.4Z	V53.17.1Z
formats.cancel_all	—	V72.18.2Z	—	—	—	—
head.latch	V53.17.16Z	V72.18.2Z	V60.16.4Z	V53.16.4Z	V53.16.4Z	V53.17.1Z
input.capture	—	V72.18.2Z	—	—	—	—

* On these printers with ZebraNet™ 10/100 Internal Print Server.

** On these printers with ZebraNet™ 10/100 External Print Server, firmware version 1.1.5

Table 49 • Table Top and Print Engine SGD Firmware Compatibility (Continued)

SGD Commands	ZE500 Series	ZT200 Series	XIIIPlus 105SL, PAX4 Z4MPlus Z6MPlus	S4M	ZM400 ZM600	Xi4
interface.network.active.arp_interval	—	V72.18.2Z	—	—	—	—
interface.network.active.cable_type	—	V72.18.2Z	—	—	—	—
interface.network.active.dhcp_received_host_name	—	V72.18.2Z	—	—	—	—
interface.network.active.gateway	V53.17.16Z	V72.18.2Z	V60.16.4Z	V53.16.4Z	V53.16.4Z	V53.17.1Z
interface.network.active.ip_addr	V53.17.16Z	V72.18.2Z	V60.16.4Z	V53.16.4Z	V53.16.4Z	V53.17.1Z
interface.network.active.mac_addr	V53.17.16Z	V72.18.2Z	V60.16.4Z	V53.16.4Z	V53.16.4Z	V53.17.1Z
interface.network.active.mac_raw	V53.17.16Z	V72.18.2Z	V60.16.4Z	V53.16.4Z	V53.16.4Z	V53.17.1Z
interface.network.active.netmask	V53.17.16Z	V72.18.2Z	V60.16.4Z	V53.16.4Z	V53.16.4Z	V53.17.1Z
interface.network.active.protocol	V53.17.16Z	V72.18.2Z	V60.16.4Z	V53.16.4Z	V53.16.4Z	V53.17.1Z
interface.network.active.protocol_error	—	V72.18.2Z	—	—	—	—
interface.network.active.rx_errors	—	V72.18.2Z	—	—	—	—
interface.network.active.rx_packets	—	V72.18.2Z	—	—	—	—
interface.network.active.server_address	—	V72.18.2Z	—	—	—	—
interface.network.active.speed	—	V72.18.2Z	—	—	—	—
interface.network.active.tx_errors	—	V72.18.2Z	—	—	—	—
interface.network.active.tx_packets	—	V72.18.2Z	—	—	—	—
interface.network.active.wins_addr	—	V72.18.2Z	—	—	—	—
internal_wired.auto_switchover	V53.17.16Z	V72.18.2Z	V60.16.4Z	V53.16.4Z	V53.16.4Z	V53.17.1Z
internal_wired.ip.addr	V53.17.16Z	V72.18.2Z	—	—	* V53.15.5Z	V53.17.1Z
internal_wired.ip.arp_interval	V53.17.16Z	V72.18.2Z	—	—	* V53.15.5Z	V53.17.1Z
internal_wired.ip.default_addr_enable	V53.17.16Z	V72.18.2Z	—	—	* V53.15.5Z	V53.17.1Z
internal_wired.ip.dhcp.cache_ip	V53.17.16Z	V72.18.2Z	V60.16.4Z	V53.16.4Z	V53.16.4Z	V53.17.1Z
internal_wired.ip.dhcp.cid_all	V53.17.16Z	V72.18.2Z	—	—	* V53.15.5Z	V53.17.1Z
internal_wired.ip.dhcp.cid_enable	V53.17.16Z	V72.18.2Z	—	—	* V53.15.5Z	V53.17.1Z
internal_wired.ip.dhcp.cid_prefix	V53.17.16Z	V72.18.2Z	—	—	* V53.15.5Z	V53.17.1Z
internal_wired.ip.dhcp.cid_suffix	V53.17.16Z	V72.18.2Z	—	—	* V53.15.5Z	V53.17.1Z
internal_wired.ip.dhcp.cid_type	V53.17.16Z	V72.18.2Z	—	—	* V53.15.5Z	V53.17.1Z
internal_wired.ip.dhcp.lease.last_attempt	V53.17.16Z	V72.18.2Z	V60.16.4Z	V53.16.4Z	V53.16.4Z	V53.17.1Z
internal_wired.ip.dhcp.lease.length	V53.17.16Z	V72.18.2Z	V60.16.4Z	V53.16.4Z	V53.16.4Z	V53.17.1Z
internal_wired.ip.dhcp.lease.server	V53.17.16Z	V72.18.2Z	V60.16.4Z	V53.16.4Z	V53.16.4Z	V53.17.1Z
internal_wired.ip.dhcp.lease.time_left	V53.17.16Z	V72.18.2Z	V60.16.4Z	V53.16.4Z	V53.16.4Z	V53.17.1Z
internal_wired.ip.dhcp.option12	V53.17.16Z	V72.18.2Z	V60.16.4Z	V53.16.4Z	V53.16.4Z	V53.17.1Z
internal_wired.ip.dhcp.option12_format	V53.17.16Z	V72.18.2Z	V60.16.4Z	V53.16.4Z	V53.16.4Z	V53.17.1Z
internal_wired.ip.dhcp.option12_value	V53.17.16Z	V72.18.2Z	V60.16.4Z	V53.16.4Z	V53.16.4Z	V53.17.1Z
internal_wired.ip.dhcp.requests_per_session	V53.17.16Z	V72.18.2Z	V60.16.4Z	V53.16.4Z	V53.16.4Z	V53.17.1Z
internal_wired.ip.gateway	V53.17.16Z	V72.18.2Z	—	—	* V53.15.5Z	V53.17.1Z
internal_wired.ip.netmask	V53.17.16Z	V72.18.2Z	—	—	* V53.15.5Z	V53.17.1Z

* On these printers with ZebraNet™ 10/100 Internal Print Server.

** On these printers with ZebraNet™ 10/100 External Print Server, firmware version 1.1.5

Table 49 • Table Top and Print Engine SGD Firmware Compatibility (Continued)

SGD Commands	ZE500 Series	ZT200 Series	XIIIPlus 105SL, PAX4 Z4MPlus Z6MPlus	S4M	ZM400 ZM600	Xi4
internal_wired.ip.port	V53.17.16Z	V72.18.2Z	—	—	V53.15.5Z	V53.17.1Z
internal_wired.ip.port.alternate	—	V72.18.2Z	—	—	—	—
internal_wired.ip.protocol	V53.17.16Z	V72.18.2Z	—	—	* V53.15.5Z	V53.17.1Z
internal_wired.ip.timeout.enable	V53.17.16Z	V72.18.2Z	—	—	* V53.15.5Z	V53.17.1Z
internal_wired.ip.timeout.value	V53.17.16Z	V72.18.2Z	—	—	* V53.15.5Z	V53.17.1Z
internal_wired.mac_addr	V53.17.16Z	V72.18.2Z	—	—	* V53.15.5Z	V53.17.1Z
internal_wired.mac_raw	V53.17.16Z	V72.18.2Z	V60.16.4Z	V53.16.4Z	V53.16.4Z	V53.17.1Z
ip.active_network	V53.17.16Z	V72.18.2Z	V60.15.8Z	—	V53.15.5Z	V53.17.1Z
ip.addr	V53.17.16Z	V72.18.2Z	V60.15.2Z	—	V53.15.5Z	V53.17.1Z
ip.arp_interval	V53.17.16Z	V72.18.2Z	V60.15.2Z	V50.15.2Z	V53.15.5Z	V53.17.1Z
ip.bootp.enable	V53.17.16Z	V72.18.2Z	V60.15.2Z	V53.15.5Z V50.15.2Z	V53.15.5Z	V53.17.1Z
ip.dhcp.arp_verify	—	V72.18.2Z	—	—	—	—
ip.dhcp.auto_provision_enable	—	V72.19.6Z	—	—	—	—
ip.dhcp.cache_ip	V53.17.16Z	V72.18.2Z	V60.16.4Z	V53.16.4Z	V53.16.4Z	V53.17.1Z
ip.dhcp.cid_all	V53.17.16Z	V72.18.2Z	V60.15.2Z	V50.15.2Z	V53.15.5Z	V53.17.1Z
ip.dhcp.cid_enable	V53.17.16Z	V72.18.2Z	V60.15.2Z	V50.15.2Z	V53.15.5Z	V53.17.1Z
ip.dhcp.cid_prefix	V53.17.16Z	V72.18.2Z	V60.15.2Z	V50.15.2Z	V53.15.5Z	V53.17.1Z
ip.dhcp.cid_suffix	V53.17.16Z	V72.18.2Z	V60.15.2Z	V50.15.2Z	V53.15.5Z	V53.17.1Z
ip.dhcp.cid_type	V53.17.16Z	V72.18.2Z	V60.15.2Z	V50.15.2Z	V53.15.5Z	V53.17.1Z
ip.dhcp.enable	V53.17.16Z	V72.18.2Z	V60.15.2Z	V53.15.5Z V50.15.2Z	V53.15.5Z	V53.17.1Z
ip.dhcp.lease.last_attempt	V53.17.16Z	V72.18.2Z	V60.16.4Z	V53.16.4Z	V53.16.4Z	V53.17.1Z
ip.dhcp.lease.server	V53.17.16Z	V72.18.2Z	V60.16.4Z	V53.16.4Z	V53.16.4Z	V53.17.1Z
ip.dhcp.lease.time_left	V53.17.16Z	V72.18.2Z	V60.16.4Z	V53.16.4Z	V53.16.4Z	V53.17.1Z
ip.dhcp.option12	V53.17.16Z	V72.18.2Z	V60.16.4Z	V53.16.4Z	V53.16.4Z	V53.17.1Z
ip.dhcp.option12_format	V53.17.16Z	V72.18.2Z	V60.16.4Z	V53.16.4Z	V53.16.4Z	V53.17.1Z
ip.dhcp.option12_value	V53.17.16Z	V72.18.2Z	V60.16.4Z	V53.16.4Z	V53.16.4Z	V53.17.1Z
ip.dhcp.request_timeout	V53.17.16Z	V72.18.2Z	V60.16.4Z	V53.16.4Z	V53.16.4Z	V53.17.1Z
ip.dhcp.requests_per_session	V53.17.16Z	V72.18.2Z	V60.16.4Z	V53.16.4Z	V53.16.4Z	V53.17.1Z
ip.dhcp.session_interval	V53.17.16Z	V72.18.2Z	V60.16.4Z	V53.16.4Z	V53.16.4Z	V53.17.1Z
ip.dhcp.vendor_class_id	—	V72.19.6Z	—	—	—	—
ip.dns.domain	V53.17.16Z	V72.18.2Z	V60.16.4Z	V53.16.4Z	V53.16.4Z	V53.17.1Z
ip.dns.servers	V53.17.16Z	V72.18.2Z	V60.16.4Z	V53.16.4Z	V53.16.4Z	V53.17.1Z
ip.ftp.enable	V53.17.16Z	V72.18.2Z	V60.15.2Z	V50.15.2Z	V53.15.5Z	V53.17.1Z
ip.ftp.execute_file	V53.17.16Z	V72.18.2Z	V60.15.2Z	V50.15.2Z	V53.15.5Z	V53.17.1Z
ip.ftp.request_password	—	V72.18.2Z	—	—	—	—
ip.gateway	V53.17.16Z	V72.18.2Z	V60.15.2Z	V50.15.2Z	V53.15.5Z	V53.17.1Z

* On these printers with ZebraNet™ 10/100 Internal Print Server.

** On these printers with ZebraNet™ 10/100 External Print Server, firmware version 1.1.5

Table 49 • Table Top and Print Engine SGD Firmware Compatibility (Continued)

SGD Commands	ZE500 Series	ZT200 Series	XIIIPlus 105SL, PAX4 Z4MPlus Z6MPlus	S4M	ZM400 ZM600	Xi4
ip.http.admin_name	—	V72.18.2Z	—	—	—	—
ip.http.admin_password	—	V72.18.2Z	—	—	—	—
ip.http.custom_link_name	—	V72.18.2Z	—	—	—	—
ip.http.custom_link_url	—	V72.18.2Z	—	—	—	—
ip.http.enable	V53.17.16Z	V72.18.2Z	V60.15.2Z	V50.15.2Z	V53.15.5Z	V53.17.1Z
ip.http.faq_url	—	V72.18.2Z	—	—	—	—
ip.http.port	—	V72.18.2Z	—	—	—	—
ip.lpd.enable	V53.17.16Z	V72.18.2Z	V60.15.2Z	V50.15.2Z	V53.15.5Z	V53.17.1Z
ip.mac_raw	V53.17.16Z	V72.18.2Z	V60.16.4Z	V53.16.4Z	V53.16.4Z	V53.17.1Z
ip.mirror.appl_path	—	V72.19.6Z	—	—	—	—
ip.mirror.auto	V53.17.2Z	V72.18.2Z	V60.16.4Z	V53.17.2Z	V53.17.2Z	V53.17.2Z
ip.mirror.error_retry	V53.17.2Z	V72.18.2Z	V60.17.2Z	V53.17.2Z	V53.17.2Z	V53.17.2Z
ip.mirror.feedback.auto	V53.17.2Z	V72.18.2Z	V60.17.2Z	V53.17.2Z	V53.17.2Z	V53.17.2Z
ip.mirror.feedback.freq	V53.17.2Z	V72.18.2Z	V60.17.2Z	V53.17.2Z	V53.17.2Z	V53.17.2Z
ip.mirror.feedback.odometer	V53.17.2Z	V72.18.2Z	V60.17.2Z	V53.17.2Z	V53.17.2Z	V53.17.2Z
ip.mirror.feedback.path	V53.17.2Z	V72.18.2Z	V60.17.2Z	V53.17.2Z	V53.17.2Z	V53.17.2Z
ip.mirror.fetch	V53.17.2Z	V72.18.2Z	V60.17.2Z	V53.17.2Z	V53.17.2Z	V53.17.2Z
ip.mirror.freq	V53.17.2Z	V72.18.2Z	V60.17.2Z	V53.17.2Z	V53.17.2Z	V53.17.2Z
ip.mirror.freq_hours	V53.17.2Z	V72.18.2Z	V60.17.2Z	V53.17.2Z	V53.17.2Z	V53.17.2Z
ip.mirror.last_error	V53.17.2Z	V72.18.2Z	V60.17.2Z	V53.17.2Z	V53.17.2Z	V53.17.2Z
ip.mirror.last_time	V53.17.2Z	V72.18.2Z	V60.17.2Z	V53.17.2Z	V53.17.2Z	V53.17.2Z
ip.mirror.mode	—	V72.19.6Z	—	—	—	—
ip.mirror.password	V53.17.2Z	V72.18.2Z	V60.17.2Z	V53.17.2Z	V53.17.2Z	V53.17.2Z
ip.mirror.path	V53.17.2Z	V72.18.2Z	V60.17.2Z	V53.17.2Z	V53.17.2Z	V53.17.2Z
ip.mirror.reset_delay	V53.17.2ZA	V72.18.2Z	V60.17.2ZA	V53.17.2ZA	V53.17.2ZA	V53.17.2ZA
ip.mirror.server	V53.17.2Z	V72.18.2Z	V60.17.2Z	V53.17.2Z	V53.17.2Z	V53.17.2Z
ip.mirror.success	V53.17.2Z	V72.18.2Z	V60.17.2Z	V53.17.2Z	V53.17.2Z	V53.17.2Z
ip.mirror.success_time	V53.17.2Z	V72.18.2Z	V60.17.2Z	V53.17.2Z	V53.17.2Z	V53.17.2Z
ip.mirror.username	V53.17.2Z	V72.18.2Z	V60.17.2Z	V53.17.2Z	V53.17.2Z	V53.17.2Z
ip.mirror.version	V53.17.2Z	V72.18.2Z	V60.17.2Z	V53.17.2Z	V53.17.2Z	V53.17.2Z
ip.netmask	V53.17.16Z	V72.18.2Z	V60.15.2Z	V50.15.2Z	V53.15.5Z	V53.17.1Z
ip.pop3.enable	V53.17.16Z	V72.18.2Z	V60.15.2Z	V50.15.2Z	V53.15.5Z	V53.17.1Z
ip.pop3.password	V53.17.16Z	V72.18.2Z	V60.15.2Z	V50.15.2Z	V53.15.5Z	V53.17.1Z
ip.pop3.poll	V53.17.16Z	V72.18.2Z	V60.15.2Z	V50.15.2Z	V53.15.5Z	V53.17.1Z
ip.pop3.server_addr	V53.17.16Z	V72.18.2Z	V60.15.2Z	V50.15.2Z	V53.15.5Z	V53.17.1Z
ip.pop3.username	V53.17.16Z	V72.18.2Z	V60.15.2Z	V50.15.2Z	V53.15.5Z	V53.17.1Z
ip.port	V53.17.16Z	V72.18.2Z	V60.15.2Z	V50.15.2Z	V53.15.5Z	V53.17.1Z

* On these printers with ZebraNet™ 10/100 Internal Print Server.

** On these printers with ZebraNet™ 10/100 External Print Server, firmware version 1.1.5

Table 49 • Table Top and Print Engine SGD Firmware Compatibility (Continued)

SGD Commands	ZE500 Series	ZT200 Series	XIIIPlus 105SL, PAX4 Z4MPlus Z6MPlus	S4M	ZM400 ZM600	Xi4
ip.port.alternate	—	V72.18.2Z	—	—	—	—
ip.primary.network	—	V72.19.6Z	—	—	—	—
ip.primary.network	V53.17.16Z	V72.18.2Z	V53.15.5Z	V53.15.5Z	V53.15.5Z	V53.17.1Z
ip.smtp.domain	V53.17.16Z	V72.18.2Z	V60.15.2Z	V53.15.5Z V50.15.2Z	V53.15.5Z	V53.17.1Z
ip.smtp.enable	V53.17.16Z	V72.18.2Z	V60.15.2Z	V50.15.2Z	V53.15.5Z	V53.17.1Z
ip.smtp.server_addr	V53.17.16Z	V72.18.2Z	V60.15.2Z	V53.15.5Z, V50.15.2Z	V53.15.5Z	V53.17.1Z
ip.snmp.enable	V53.17.16Z	V72.18.2Z	V60.15.2Z	V50.15.2Z	V53.15.5Z	V53.17.1Z
ip.snmp.get_community_name	V53.17.16Z	V72.18.2Z	V60.15.2Z	V53.15.5Z V50.15.2Z	V53.15.5Z	V53.17.1Z
ip.snmp.set_community_name	V53.17.16Z	V72.18.2Z	V60.15.2Z	V53.15.5Z V50.15.2Z	V53.15.5Z	V53.17.1Z
ip.snmp.trap_community_name	—	V72.18.2Z	—	—	—	—
ip.tcp.enable	V53.17.16Z	V72.18.2Z	V60.15.2Z	V50.15.2Z	V53.15.5Z	V53.17.1Z
ip.telnet.enable	V53.17.16Z	V72.18.2Z	V60.15.2Z	V50.15.2Z	V53.15.5Z	V53.17.1Z
ip.udp.enable	V53.17.16Z	V72.18.2Z	V60.15.2Z	V50.15.2Z	V53.15.5Z	V53.17.1Z
media.cartridge.part_number	—	V72.18.2Z	—	—	—	—
media.cut.now	—	V72.18.2Z	—	—	—	—
media.darkness.mode	—	V72.18.2Z	—	—	—	—
media.media_low.external	—	V72.18.2Z	—	—	—	—
media.media_low.warning	V53.17.16Z	V72.18.2Z	—	—	—	V53.17.1Z
media.present.cut.amount	—	V72.18.2Z	—	—	—	—
media.present.cut.margin	—	V72.18.2Z	—	—	—	—
media.present.eject	—	V72.18.2Z	—	—	—	—
media.present.length.addition	—	V72.18.2Z	—	—	—	—
media.present.loop.length	—	V72.18.2Z	—	—	—	—
media.present.loop.length.max	—	V72.18.2Z	—	—	—	—
media.present.present.timeout	—	V72.18.2Z	—	—	—	—
media.present.present.type	—	V72.18.2Z	—	—	—	—
media.printmode	V53.17.16Z	V72.18.2Z	V60.15.8Z	V53.15.5Z	V53.15.5Z	V53.17.1Z
media.speed	V53.17.16Z	V72.18.2Z	V60.16.4Z	V53.16.4Z	V53.16.4Z	V53.17.1Z
memory.flash.free	V53.17.2Z	V72.18.2Z	V60.17.7Z	V50.15.0	V53.15.5Z	V53.17.2Z
memory.flash.size	V53.17.2Z	V72.18.2Z	V60.17.7Z	V50.15.0	V53.15.5Z	V53.17.2Z
memory.ram.free	V53.17.2Z	V72.18.2Z	V60.17.7Z	V50.15.0	V53.15.5Z	V53.17.2Z
memory.ram.size	V53.17.2Z	V72.18.2Z	V60.17.7Z	V50.15.0	V53.15.5Z	V53.17.2Z
netmanage.avalanche.available_port	—	V72.18.2Z	—	—	—	—
netmanage.avalanche.startup_update	—	V72.18.2Z	—	—	—	—
netmanage.avalanche.agent_addr	—	V72.18.2Z	—	—	—	—

* On these printers with ZebraNet™ 10/100 Internal Print Server.

** On these printers with ZebraNet™ 10/100 External Print Server, firmware version 1.1.5

Table 49 • Table Top and Print Engine SGD Firmware Compatibility (Continued)

SGD Commands	ZE500 Series	ZT200 Series	XIIIPlus 105SL, PAX4 Z4MPlus Z6MPlus	S4M	ZM400 ZM600	Xi4
netmanage.avalanche.available_agent	—	V72.18.2Z	—	—	—	—
netmanage.avalanche.encryption_type	—	V72.18.2Z	—	—	—	—
netmanage.avalanche.interval	—	V72.18.2Z	—	—	—	—
netmanage.avalanche.interval_update	—	V72.18.2Z	—	—	—	—
netmanage.avalanche.model_name	—	V72.18.2Z	—	—	—	—
netmanage.avalanche.set_property	—	V72.18.2Z	—	—	—	—
netmanage.avalanche.tcp_connection_timeout	—	V72.18.2Z	—	—	—	—
netmanage.avalanche.text_msg.beep	—	V72.18.2Z	—	—	—	—
netmanage.avalanche.text_msg.display	—	V72.18.2Z	—	—	—	—
netmanage.avalanche.text_msg.print	—	V72.18.2Z	—	—	—	—
netmanage.avalanche.udp_timeout	—	V72.18.2Z	—	—	—	—
odometer.headclean	V53.17.16Z	V72.18.2Z	V60.15.8Z	V53.15.5Z	V53.15.5Z	V53.17.1Z
odometer.headnew	V53.17.16Z	V72.18.2Z	V60.15.8Z	V53.15.5Z	V53.15.5Z	V53.17.1Z
odometer.label_dot_length	V53.17.16Z	V72.18.2Z	V60.15.8Z	V53.15.5Z	V53.15.5Z	V53.17.1Z
odometer.media_marker_count1	V53.17.16Z	V72.18.2Z	V60.15.8Z	V53.15.5Z	V53.15.5Z	V53.17.1Z
odometer.media_marker_count2	V53.17.16Z	V72.18.2Z	V60.15.8Z	V53.15.5Z	V53.15.5Z	V53.17.1Z
odometer.retracts_count	—	V72.18.2Z	—	—	—	—
odometer.rfid.valid_resetable	—	—	—	—	—	—
odometer.rfid.void_resetable	—	—	—	—	—	—
odometer.total_print_length	V53.17.16Z	V72.18.2Z	V60.15.8Z	V53.15.5Z	V53.15.5Z	V53.17.1Z
parallel_port.mode	—	V72.18.2Z	—	—	—	—
parallel_port.present	—	V72.18.2Z	—	—	—	—
power.dtr_power_off	—	V72.18.2Z	—	—	—	—
print.tone	V53.17.16Z	V72.18.2Z	V60.16.4Z	V53.16.4Z	V53.16.4Z	V53.17.1Z
rfid.country_code	—	—	—	—	—	—
rfid.enable	—	—	—	—	—	—
rfid.error.response	—	—	—	—	—	—
rfid.position.program	—	—	—	—	—	—
rfid.reader_1.firmware_version	—	—	—	—	—	—
rfid.reader_1.hardware_version	—	—	—	—	—	—
rfid.reader_1.model	—	—	—	—	—	—
rfid.reader_1.power.read	—	—	—	—	—	—
rfid.reader_1.power.write	—	—	—	—	—	—
rfid.tag.read.content	—	—	—	—	—	—
rfid.tag.read.execute	—	—	—	—	—	—
rfid.tag.read.result_line1	—	—	—	—	—	—
rfid.tag.read.result_line1	—	—	—	—	—	—

* On these printers with ZebraNet™ 10/100 Internal Print Server.

** On these printers with ZebraNet™ 10/100 External Print Server, firmware version 1.1.5

Table 49 • Table Top and Print Engine SGD Firmware Compatibility (Continued)

SGD Commands	ZE500 Series	ZT200 Series	XIIIPlus 105SL, PAX4 Z4MPlus Z6MPlus	S4M	ZM400 ZM600	Xi4
rfid.tag.read.result_line1_alternate	—	—	—	—	—	—
rfid.tag.read.result_line2	—	—	—	—	—	—
rfid.tag.read.result_line2_alternate	—	—	—	—	—	—
rfid.tag.test.content	—	—	—	—	—	—
rfid.tag.test.execute	—	—	—	—	—	—
rfid.tag.test.result_line2	—	—	—	—	—	—
usb.device.device_id_string	—	V72.18.2Z	—	—	—	—
usb.device.device_unique_id	—	V72.18.2Z	—	—	—	—
usb.device.device_version	—	V72.18.2Z	—	—	—	—
usb.device.manufacturer_string	—	V72.18.2Z	—	—	—	—
usb.device.product_id	—	V72.18.2Z	—	—	—	—
usb.device.product_string	—	V72.18.2Z	—	—	—	—
usb.device.serial_string	—	V72.18.2Z	—	—	—	—
usb.device.vendor_id	—	V72.18.2Z	—	—	—	—
usb.halt	—	V72.18.2Z	—	—	—	—
weblink.ip.conn[1 2].location	—	V72.19.6Z	—	—	—	—
weblink.ip.conn[1 2].num_connections	—	V72.19.6Z	—	—	—	—
wlan.11n.20mhz_only	—	V72.18.2Z	—	—	—	—
wlan.11n.aggregation	—	V72.18.2Z	—	—	—	—
wlan.11n.greenfield	—	V72.18.2Z	—	—	—	—
wlan.11n.rifs	—	V72.18.2Z	—	—	—	—
wlan.11n.short_gi_20mhz	—	V72.18.2Z	—	—	—	—
wlan.11n.short_gi_40mhz	—	V72.18.2Z	—	—	—	—
wlan.active_channels	—	V72.18.2Z	—	—	—	—
wlan.adhocautomode	V53.17.16Z	V72.18.2Z	V60.15.2Z	V50.15.2Z	V53.15.5Z	V53.17.1Z
wlan.adhocchannel	V53.17.16Z	V72.18.2Z	V60.15.2Z	V50.15.2Z	V53.15.5Z	V53.17.1Z
wlan.allowed_band	—	V72.18.2Z	—	—	—	—
wlan.associated	V53.17.16Z	V72.18.2Z	V60.15.2Z	V50.15.2Z	V53.15.5Z	V53.17.1Z
wlan.bssid	V53.17.16Z	V72.18.2Z	V60.16.4Z	V53.16.4Z	V53.16.4Z	V53.17.1Z
wlan.channel	V53.17.16Z	V72.18.2Z	V60.16.4Z	V53.16.4Z	V53.16.4Z	V53.17.1Z
wlan.channel_mask						
wlan.channel_mask	V53.17.16Z	V72.18.2Z	V60.15.2Z	V50.15.2Z	V53.15.5Z	V53.17.1Z
wlan.current_tx_rate	V53.17.16Z	V72.18.2Z	V60.16.4Z	V53.16.4Z	V53.16.4Z	V53.17.1Z
wlan.essid	V53.17.16Z	V72.18.2Z	V60.15.2Z	V50.15.2Z	V53.15.5Z	V53.17.1Z
wlan.firmware_version	V53.17.16Z	V72.18.2Z	V60.15.2Z	V50.15.2Z	V53.15.5Z	V53.17.1Z
wlan.ip.addr	V53.17.16Z	V72.18.2Z	V60.15.8Z	V53.15.5Z	V53.15.5Z	V53.17.1Z
wlan.ip.arp_interval	V53.17.16Z	V72.18.2Z	V60.15.8Z	V53.15.5Z	V53.15.5Z	V53.17.1Z

* On these printers with ZebraNet™ 10/100 Internal Print Server.

** On these printers with ZebraNet™ 10/100 External Print Server, firmware version 1.1.5

Table 49 • Table Top and Print Engine SGD Firmware Compatibility (Continued)

SGD Commands	ZE500 Series	ZT200 Series	XIIIPlus 105SL, PAX4 Z4MPlus Z6MPlus	S4M	ZM400 ZM600	Xi4
wlan.ip.default_addr_enable	V53.17.16Z	V72.18.2Z	V60.15.8Z	V53.15.5Z	V53.15.5Z	V53.17.1Z
wlan.ip.dhcp.cache_ip	V53.17.16Z	V72.18.2Z	V60.16.4Z	V53.16.4Z	V53.16.4Z	V53.17.1Z
wlan.ip.dhcp.cid_all	V53.17.16Z	V72.18.2Z	V60.15.8Z	V53.15.5Z	V53.15.5Z	V53.17.1Z
wlan.ip.dhcp.cid_enable	V53.17.16Z	V72.18.2Z	V60.15.8Z	V53.15.5Z	V53.15.5Z	V53.17.1Z
wlan.ip.dhcp.cid_prefix	V53.17.16Z	V72.18.2Z	V60.15.8Z	V53.15.5Z	V53.15.5Z	V53.17.1Z
wlan.ip.dhcp.cid_suffix	V53.17.16Z	V72.18.2Z	V60.15.8Z	V53.15.5Z	V53.15.5Z	V53.17.1Z
wlan.ip.dhcp.cid_type	V53.17.16Z	V72.18.2Z	V60.15.8Z	V53.15.5Z	V53.15.5Z	V53.17.1Z
wlan.ip.dhcp.lease.last_attempt	V53.17.2Z	V72.18.2Z	V60.15.0	V50.15.0	V53.15.5Z	V53.17.2Z
wlan.ip.dhcp.lease.length	V53.17.16Z	V72.18.2Z	V60.16.4Z	V53.16.4Z	V53.16.4Z	V53.17.1Z
wlan.ip.dhcp.lease.server	V53.17.16Z	V72.18.2Z	V60.16.4Z	V53.16.4Z	V53.16.4Z	V53.17.1Z
wlan.ip.dhcp.lease.time_left	V53.17.16Z	V72.18.2Z	V60.16.4Z	V53.16.4Z	V53.16.4Z	V53.17.1Z
wlan.ip.dhcp.option12	V53.17.16Z	V72.18.2Z	V60.16.4Z	V53.16.4Z	V53.16.4Z	V53.17.1Z
wlan.ip.dhcp.option12_format	V53.17.16Z	V72.18.2Z	V60.16.4Z	V53.16.4Z	V53.16.4Z	V53.17.1Z
wlan.ip.dhcp.option12_value	V53.17.16Z	V72.18.2Z	V60.16.4Z	V53.16.4Z	V53.16.4Z	V53.17.1Z
wlan.ip.dhcp.request_timeout	V53.17.16Z	V72.18.2Z	V60.16.4Z	V53.16.4Z	V53.16.4Z	V53.17.1Z
wlan.ip.dhcp.requests_per_session	V53.17.16Z	V72.18.2Z	V60.16.4Z	V53.16.4Z	V53.16.4Z	V53.17.1Z
wlan.ip.dhcp.session_interval	V53.17.16Z	V72.18.2Z	V60.16.4Z	V53.16.4Z	V53.16.4Z	V53.17.1Z
wlan.ip.gateway	V53.17.16Z	V72.18.2Z	V60.15.8Z	V53.15.5Z	V53.15.5Z	V53.17.1Z
wlan.ip.netmask	V53.17.16Z	V72.18.2Z	V60.15.8Z	V53.15.5Z	V53.15.5Z	V53.17.1Z
wlan.ip.port	V53.17.16Z	V72.18.2Z	V60.15.8Z	V53.15.5Z	V53.15.5Z	V53.17.1Z
wlan.ip.port_alternate	—	V72.18.2Z	—	—	—	—
wlan.ip.protocol	V53.17.16Z	V72.18.2Z	V60.15.8Z	V53.15.5Z	V53.15.5Z	V53.17.1Z
wlan.ip.timeout.enable	V53.17.16Z	V72.18.2Z	V60.15.8Z	V53.15.5Z	V53.15.5Z	V53.17.1Z
wlan.ip.timeout.value	V53.17.16Z	V72.18.2Z	V60.15.8Z	V53.15.5Z	V53.15.5Z	V53.17.1Z
wlan.keep_alive.enable	V53.17.16Z	V72.18.2Z	V60.15.2Z	V50.15.2Z	V53.15.5Z	V53.17.1Z
wlan.keep_alive.timeout	V53.17.16Z	V72.18.2Z	V60.15.2Z	V50.15.2Z	V53.15.5Z	V53.17.1Z
wlan.kerberos.kdc	V53.17.16Z	V72.18.2Z	V60.15.2Z	V50.15.2Z	V53.15.5Z	V53.17.1Z
wlan.kerberos.password	V53.17.16Z	V72.18.2Z	V60.15.2Z	V50.15.2Z	V53.15.5Z	V53.17.1Z
wlan.kerberos.realm	V53.17.16Z	V72.18.2Z	V60.15.2Z	V50.15.2Z	V53.15.5Z	V53.17.1Z
wlan.kerberos.username	V53.17.16Z	V72.18.2Z	V60.15.2Z	V50.15.2Z	V53.15.5Z	V53.17.1Z
wlan.mac_addr	V53.17.16Z	V72.18.2Z	V60.15.8Z	V53.15.5Z	V53.15.5Z	V53.17.1Z
wlan.mac_raw	V53.17.16Z	V72.18.2Z	V60.16.4Z	V53.16.4Z	V53.16.4Z	V53.17.1Z
wlan.operating_mode	V53.17.16Z	V72.18.2Z	V60.15.2Z	V50.15.2Z	V53.15.5Z	V53.17.1Z
wlan.password	V53.17.16Z	V72.18.2Z	V60.15.2Z	V50.15.2Z	V53.15.5Z	V53.17.1Z
wlan.permitted_channels	—	V72.18.2Z	—	—	—	—
wlan.preamble	V53.17.16Z	V72.18.2Z	V60.15.2Z	V50.15.2Z	V53.15.5Z	V53.17.1Z
wlan.private_key_password	V53.17.16Z	V72.18.2Z	V60.15.2Z	V50.15.2Z	V53.15.5Z	V53.17.1Z

* On these printers with ZebraNet™ 10/100 Internal Print Server.

** On these printers with ZebraNet™ 10/100 External Print Server, firmware version 1.1.5

Table 49 • Table Top and Print Engine SGD Firmware Compatibility (Continued)

SGD Commands	ZE500 Series	ZT200 Series	XIIIPlus 105SL, PAX4 Z4MPlus Z6MPlus	S4M	ZM400 ZM600	Xi4
wlan.roam.interchannel_delay	V53.17.16Z	V72.18.2Z	V60.16.4Z	V53.16.4Z	V53.16.4Z	V53.17.1Z
wlan.roam.interval	V53.17.16Z	V72.18.2Z	V60.15.2Z	V50.15.2Z	V53.15.5Z	V53.17.1Z
wlan.roam.max_chan_scan_time	V53.17.16Z	V72.18.2Z	V60.16.4Z	V53.16.4Z	V53.16.4Z	V53.17.1Z
wlan.roam.max_fail	V53.17.11Z	V72.18.2Z	V60.17.11Z	V53.17.11Z	V53.17.11Z	V53.17.11Z
wlan.roam.rssi	V53.17.11Z	V72.18.2Z	V60.17.11Z	V53.17.11Z	V53.17.11Z	V53.17.11Z
wlan.roam.signal	V53.17.16Z	V72.18.2Z	V60.15.2Z	V50.15.2Z	V53.15.5Z	V53.17.1Z
wlan.security	V53.17.16Z	V72.18.2Z	V60.15.2Z	V50.15.2Z	V53.15.5Z	V53.17.1Z
wlan.signal_noise	V53.17.16Z	V72.18.2Z	V60.15.2Z	V50.15.2Z	V53.15.5Z	V53.17.1Z
wlan.signal_quality	V53.17.16Z	V72.18.2Z	V60.15.2Z	V50.15.2Z	V53.15.5Z	V53.17.1Z
wlan.signal_strength	V53.17.16Z	V72.18.2Z	V60.15.2Z	V50.15.2Z	V53.15.5Z	V53.17.1Z
wlan.station_name	V53.17.16Z	V72.18.2Z	V60.15.2Z	V50.15.2Z	V53.15.5Z	V53.17.1Z
wlan.tx_power	V53.17.16Z	V72.18.2Z	V60.15.2Z	V50.15.2Z	V53.15.5Z	V53.17.1Z
wlan.tx_rate	V53.17.16Z	V72.18.2Z	V60.15.2Z	V50.15.2Z	V53.15.5Z	V53.17.1Z
wlan.user_channel_list	—	V72.18.2Z	—	—	—	—
wlan.username	V53.17.16Z	V72.18.2Z	V60.15.2Z	V50.15.2Z	V53.15.5Z	V53.17.1Z
wlan.waveagent.enable	—	V72.18.2Z	—	—	—	—
wlan.waveagent.udp_port	—	V72.18.2Z	—	—	—	—
wlan.wep.auth_type	V53.17.16Z	V72.18.2Z	V60.15.2Z	V50.15.2Z	V53.15.5Z	V53.17.1Z
wlan.wep.index	V53.17.16Z	V72.18.2Z	V60.15.2Z	V50.15.2Z	V53.15.5Z	V53.17.1Z
wlan.wep.key_format	V53.17.16Z	V72.18.2Z	V60.15.2Z	V50.15.2Z	V53.15.5Z	V53.17.1Z
wlan.wep.key1	V53.17.16Z	V72.18.2Z	V60.15.2Z	V50.15.2Z	V53.15.5Z	V53.17.1Z
wlan.wep.key2	V53.17.16Z	V72.18.2Z	V60.15.2Z	V50.15.2Z	V53.15.5Z	V53.17.1Z
wlan.wep.key3	V53.17.16Z	V72.18.2Z	V60.15.2Z	V50.15.2Z	V53.15.5Z	V53.17.1Z
wlan.wep.key4	V53.17.16Z	V72.18.2Z	V60.15.2Z	V50.15.2Z	V53.15.5Z	V53.17.1Z
wlan.wpa.psk	V53.17.16Z	V72.18.2Z	V60.15.2Z	V50.15.2Z	V53.15.5Z	V53.17.1Z
zbi.control.add_breakpoint	V53.17.16Z	V72.18.2Z	V60.16.2Z	V53.16.2Z	V53.16.2Z	V53.17.1Z
zbi.control.break	V53.17.16Z	V72.18.2Z	V60.16.2Z	V53.16.2Z	V53.16.2Z	V53.17.1Z
zbi.control.clear_breakpoints	V53.17.16Z	V72.18.2Z	V60.16.2Z	V53.16.2Z	V53.16.2Z	V53.17.1Z
zbi.control.delete_breakpoint	V53.17.16Z	V72.18.2Z	V60.16.2Z	V53.16.2Z	V53.16.2Z	V53.17.1Z
zbi.control.line_number	V53.17.16Z	V72.18.2Z	V60.16.2Z	V53.16.2Z	V53.16.2Z	V53.17.1Z
zbi.control.restart	V53.17.16Z	V72.18.2Z	V60.16.2Z	V53.16.2Z	V53.16.2Z	V53.17.1Z
zbi.control.run	V53.17.16Z	V72.18.2Z	V60.16.2Z	V53.16.2Z	V53.16.2Z	V53.17.1Z
zbi.control.step	V53.17.16Z	V72.18.2Z	V60.16.2Z	V53.16.2Z	V53.16.2Z	V53.17.1Z
zbi.control.terminate	V53.17.16Z	V72.18.2Z	V60.16.2Z	V53.16.2Z	V53.16.2Z	V53.17.1Z
zbi.control.variable_name	V53.17.16Z	V72.18.2Z	V60.16.2Z	V53.16.2Z	V53.16.2Z	V53.17.1Z
zbi.control.variable_value	V53.17.16Z	V72.18.2Z	V60.16.2Z	V53.16.2Z	V53.16.2Z	V53.17.1Z
zbi.key	V53.17.16Z	V72.18.2Z	V60.16.2Z	V53.16.2Z	V53.16.2Z	V53.17.1Z

* On these printers with ZebraNet™ 10/100 Internal Print Server.

** On these printers with ZebraNet™ 10/100 External Print Server, firmware version 1.1.5

Table 49 • Table Top and Print Engine SGD Firmware Compatibility (Continued)

SGD Commands	ZE500 Series	ZT200 Series	XIIIPlus 105SL, PAX4 Z4MPlus Z6MPlus	S4M	ZM400 ZM600	Xi4
<i>zbi.last_error</i>	V53.17.16Z	V72.18.2Z	V60.16.2Z	V53.16.2Z	V53.16.2Z	V53.17.1Z
<i>zbi.reseller_key</i>	V53.17.16Z	V72.18.2Z	V60.16.2Z	V53.16.2Z	V53.16.2Z	V53.17.1Z
<i>zbi.revision</i>	V53.17.16Z	V72.18.2Z	V60.16.2Z	V53.16.2Z	V53.16.2Z	V53.17.1Z
<i>zbi.running_program_name</i>	V53.17.16Z	V72.18.2Z	V60.16.2Z	V53.16.2Z	V53.16.2Z	V53.17.1Z
<i>zbi.start_info.execute</i>	V53.17.16Z	V72.18.2Z	V60.16.2Z	V53.16.2Z	V53.16.2Z	V53.17.1Z
<i>zbi.start_info.file_name</i>	V53.17.16Z	V72.18.2Z	V60.16.2Z	V53.16.2Z	V53.16.2Z	V53.17.1Z
<i>zbi.start_info.memory_alloc</i>	V53.17.16Z	V72.18.2Z	V60.16.2Z	V53.16.2Z	V53.16.2Z	V53.17.1Z
<i>zbi.state</i>	V53.17.16Z	V72.18.2Z	V60.16.2Z	V53.16.2Z	V53.16.2Z	V53.17.1Z
<i>zpl.caret</i>	—	V72.18.2Z	—	—	—	—
<i>zpl.control_character</i>	—	V72.18.2Z	—	—	—	—
<i>zpl.delimiter</i>	—	V72.18.2Z	—	—	—	—
<i>zpl.label_length</i>	—	V72.18.2Z	—	—	—	—
<i>zpl.left_position</i>	—	V72.18.2Z	—	—	—	—
<i>zpl.system_error</i>	—	V72.18.2Z	—	—	—	—
<i>zpl.system_status</i>	—	V72.18.2Z	—	—	—	—
<i>zpl.zpl_mode</i>	—	V72.18.2Z	—	—	—	—
<i>zpl.zpl_override</i>	—	V72.18.2Z	—	—	—	—

* On these printers with ZebraNet™ 10/100 Internal Print Server.

** On these printers with ZebraNet™ 10/100 External Print Server, firmware version 1.1.5

Desktop and Kiosk Printers



Important • All the firmware versions noted in [Table 50](#) refer to the minimum firmware version required. For .RFID printer support, see [Table 51](#). For Table Top and Print Engines, see [Table 49](#).

Table 50 • Desktop and Kiosk SGD Firmware Compatibility

SGD Commands	ZD500R	HC100	G-Series, LP2824 Plus TLP 2824 Plus	GK800, GT800, GK888, GC420d, GC420t	KR403
appl.bootblock	V74.19.6Z	V54.16.1Z	V56.15.6Z V61.15.6Z V61.17.3Z	V70.17.11Z V71.17.11Z	V66.17.2Z
appl.name	V74.19.6Z	V54.16.1Z	V56.15.6Z V61.15.6Z V61.17.3Z	V70.17.11Z V71.17.11Z	—
appl.option_board_version	—	V54.16.1ZC	V56.16.5Z V61.16.5Z V61.17.3Z	V70.17.11Z V71.17.11Z	—
bluetooth.address	V74.19.6Z	—	V56.15.6Z V61.15.6Z V61.17.3Z	V70.17.11Z V71.17.11Z	—
bluetooth.afh_map	—	—	V56.15.6Z V61.15.6Z V61.17.3Z	V70.17.11Z V71.17.11Z	—
bluetooth.afh_map_curr	—	—	V56.15.6Z V61.15.6Z V61.17.3Z	V70.17.11Z V71.17.11Z	—
bluetooth.afh_mode	—	—	V56.15.6Z V61.15.6Z V61.17.3Z	V70.17.11Z V71.17.11Z	—
bluetooth.authentication	—	—	V56.15.6Z V61.15.6Z V61.17.3Z	V70.17.11Z V71.17.11Z	—
bluetooth.bluetooth_pin	—	—	V56.15.6Z V61.15.6Z V61.17.3Z	V70.17.11Z V71.17.11Z	—
bluetooth.date	V74.19.6Z	—	V56.15.6Z V61.15.6Z V61.17.3Z	V70.17.11Z V71.17.11Z	—
bluetooth.discoverable	V74.19.6Z	—	V56.15.6Z V61.15.6Z V61.17.3Z	V70.17.11Z V71.17.11Z	—
bluetooth.enable	V74.19.6Z	—	V56.15.6Z V61.15.6Z V61.17.3Z	V70.17.11Z V71.17.11Z	—
bluetooth.friendly_name	V74.19.6Z	—	V56.15.6Z V61.15.6Z V61.17.3Z	V70.17.11Z V71.17.11Z	—
bluetooth.local_name	V74.19.6Z	—	V56.15.6Z V61.15.6Z V61.17.3Z	V70.17.11Z V71.17.11Z	—

* On these printers with ZebraNet™ 10/100 Internal Print Server.

** On these printers with ZebraNet™ 10/100 External Print Server, firmware version 1.1.5

Table 50 • Desktop and Kiosk SGD Firmware Compatibility (Continued)

SGD Commands	ZD500R	HC100	G-Series, LP2824 Plus TLP 2824 Plus	GK800, GT800, GK888, GC420d, GC420t	KR403
bluetooth.radio_auto_baud	—	—	V56.15.6Z V61.15.6Z V61.17.3Z	V70.17.11Z V71.17.11Z	—
bluetooth.radio_version	V74.19.6Z	—	V56.15.6Z V61.15.6Z V61.17.3Z	V70.17.11Z V71.17.11Z	—
bluetooth.short_address	V74.19.6Z	—	V56.15.6Z V61.15.6Z V61.17.3Z	V70.17.11Z V71.17.11Z	—
bluetooth.version	V74.19.6Z	—	V56.15.6Z V61.15.6Z V61.17.3Z	V70.17.11Z V71.17.11Z	—
card.inserted	—	—	V56.15.6Z V61.15.6Z V61.17.3Z	V70.17.11Z V71.17.11Z	—
card.mac_addr	V74.19.6Z	V54.16.1Z	V56.15.6Z V61.15.6Z V61.17.3Z	V70.17.11Z V71.17.11Z	—
CISDFCRC16	—	V54.16.1ZC	—	—	—
comm.baud	V74.19.6Z	V54.16.1Z	V56.15.6Z V61.15.6Z V61.17.3Z	—	V66.17.4Z
comm.halt	V74.19.6Z	—	—	—	—
comm.parity	V74.19.6Z	V54.16.1Z	V56.15.6Z V61.15.6Z V61.17.3Z	V70.17.11Z V71.17.11Z	V66.17.4Z
comm.pnp_option	—	V54.16.1Z	V56.17.11Z V61.17.11Z	V70.17.11Z V71.17.11Z	V66.17.4Z
comm.stop_bits	V74.19.6Z	V54.16.1Z	V56.15.6Z V61.15.6Z V61.17.3Z	V70.17.11Z V71.17.11Z	V66.17.4Z
comm.type	V74.19.6Z	—	V56.17.3Z V61.17.3Z	V70.17.11Z V71.17.11Z	—
cutter.clean_cutter	V74.19.6Z	—	V56.15.6Z V61.15.6Z V61.17.3Z	V70.17.11Z V71.17.11Z	—
device.command_override.active	—	—	—	—	—
device.command_override.clear	—	—	—	—	—
device.command_override.list	—	—	—	—	—
device.cutter_installed	V74.19.6Z	—	—	—	—
device.download_connection_timeout	V74.19.6Z	V54.16.1ZC	V56.16.5Z V61.16.5Z V61.17.3Z	V70.17.11Z V71.17.11Z	—
device.epl_legacy_mode	V74.19.6Z	—	V56.17.9Z V61.17.9Z V61.17.9Z	V70.17.11Z V71.17.11Z	—

* On these printers with ZebraNet™ 10/100 Internal Print Server.

** On these printers with ZebraNet™ 10/100 External Print Server, firmware version 1.1.5

Table 50 • Desktop and Kiosk SGD Firmware Compatibility (Continued)

SGD Commands	ZD500R	HC100	G-Series, LP2824 Plus TLP 2824 Plus	GK800, GT800, GK888, GC420d, GC420t	KR403
<i>device.friendly_name</i>	V74.19.6Z	V54.16.1ZC	V56.16.5Z V61.16.5Z V61.17.3Z	V70.17.11Z V71.17.11Z	—
<i>device.frontpanel.feedenabled</i>	—	—	V61.17.11Z, V56.17.11Z,	V70.17.11Z V71.17.11Z	—
<i>device.frontpanel.key_press</i>	V74.19.6Z	—	V56.16.5Z V61.16.5Z V61.17.3Z	V70.17.11Z V71.17.11Z	—
<i>device.frontpanel.line1</i>	V74.19.6Z	—	V56.16.5Z V61.16.5Z V61.17.3Z	V70.17.11Z V71.17.11Z	—
<i>device.frontpanel.line2</i>	V74.19.6Z	—	V56.16.5Z V61.16.5Z V61.17.3Z	V70.17.11Z V71.17.11Z	—
<i>device.frontpanel.xml</i>	V74.19.6Z	—	V56.16.5Z V61.16.5Z V61.17.3Z	V70.17.11Z V71.17.11Z	—
<i>device.host_identification</i>	V74.19.6Z	—	—	—	—
<i>device.host_status</i>	V74.19.6Z	—	—	—	—
<i>device.jobs_print</i>	V74.19.6Z	V54.16.1ZC	V61.17.3Z	V70.17.11Z V71.17.11Z	—
<i>device.languages</i>	V74.19.6Z	V54.16.1ZC	V56.15.6Z V61.15.6Z V61.17.3Z	V70.17.11Z V71.17.11Z	—
<i>device.ltu_installed</i>	V74.19.6Z	—	—	—	—
<i>device.orientation</i>	—	—	V61.17.3Z	V70.17.11Z V71.17.11Z	V66.17.2Z
<i>device.pause</i>	V74.19.6Z	—	—	—	—
<i>device.pnp_option</i>	V74.19.6Z	—	V56.15.6Z V61.15.6Z V61.17.3Z	V70.17.11Z V71.17.11Z	—
<i>device.position.accuracy</i>	V74.19.6Z	—	—	—	—
<i>device.position.altitude</i>	V74.19.6Z	—	—	—	—
<i>device.position.latitude</i>	V74.19.6Z	—	—	—	—
<i>device.position.longitude</i>	V74.19.6Z	—	—	—	—
<i>device.print_reprogram_2key</i>	—	—	—	—	—
<i>device.reset</i>	V74.19.6Z	V54.16.1ZC	V56.15.6Z V61.15.6Z V61.17.3Z	V70.17.11Z V71.17.11Z	—
<i>device.restore_defaults</i>	V74.19.6Z	V54.16.1ZC	V56.15.6Z V61.15.6Z V61.17.3Z	V70.17.11Z V71.17.11Z	—
<i>device.super_host_status</i>	V74.19.6Z	—	—	—	—
<i>device.unique_id</i>	V74.19.6Z	V54.16.1Z	V56.15.6Z V61.15.6Z V61.17.3Z	V70.17.11Z V71.17.11Z	—

* On these printers with ZebraNet™ 10/100 Internal Print Server.

** On these printers with ZebraNet™ 10/100 External Print Server, firmware version 1.1.5

Table 50 • Desktop and Kiosk SGD Firmware Compatibility (Continued)

SGD Commands	ZD500R	HC100	G-Series, LP2824 Plus TLP 2824 Plus	GK800, GT800, GK888, GC420d, GC420t	KR403
device.unpause	V74.19.6Z	—	—	—	—
device.uptime	V74.19.6Z	V54.16.1ZC	V56.15.6Z V61.15.6Z V61.17.3Z	V70.17.11Z V71.17.11Z	—
device.user_p1	V74.19.6Z	V54.16.1ZC	V56.15.6Z V61.15.6Z V61.17.3Z	V70.17.11Z V71.17.11Z	—
device.user_p2	V74.19.6Z	V54.16.1ZC	V56.15.6Z V61.15.6Z V61.17.3Z	V70.17.11Z V71.17.11Z	—
device.xml.enable	V74.19.6Z	V54.16.1ZC	V56.15.6Z V61.15.6Z V61.17.3Z	V70.17.11Z V71.17.11Z	—
display.backlight	V74.19.6Z	—	—	—	—
display.backlight_on_time	V74.19.6Z	—	—	—	—
display.language	V74.19.6Z	—	—	—	—
display.load_card	V74.19.6Z	—	—	—	—
display.text	V74.19.6Z	—	V56.16.5Z V61.17.3Z	V70.17.11Z V71.17.11Z	—
external_wired.check	—	—	V56.15.6Z V61.15.6Z V61.17.3Z	V70.17.11Z V71.17.11Z	—
external_wired.ip.addr	—	—	V56.15.6Z V61.15.6Z V61.17.3Z	V70.17.11Z V71.17.11Z	—
external_wired.ip.arp_interval	—	—	V56.15.6Z V61.15.6Z V61.17.3Z	V70.17.11Z V71.17.11Z	—
external_wired.ip.default_addr_enable	—	—	V56.15.6Z V61.15.6Z V61.17.3Z	V70.17.11Z V71.17.11Z	—
external_wired.ip.dhcp.cid_all	—	—	V56.15.6Z V61.15.6Z V61.17.3Z	V70.17.11Z V71.17.11Z	—
external_wired.ip.dhcp.cid_enable	—	—	V56.15.6Z V61.15.6Z V61.17.3Z	V70.17.11Z V71.17.11Z	—
external_wired.ip.dhcp.cid_prefix	—	—	V56.15.6Z V61.15.6Z V61.17.3Z	V70.17.11Z V71.17.11Z	—
external_wired.ip.dhcp.cid_suffix	—	—	V56.15.6Z V61.15.6Z V61.17.3Z	V70.17.11Z V71.17.11Z	—
external_wired.ip.dhcp.cid_type	—	—	V56.15.6Z V61.15.6Z V61.17.3Z	V70.17.11Z V71.17.11Z	—

* On these printers with ZebraNet™ 10/100 Internal Print Server.

** On these printers with ZebraNet™ 10/100 External Print Server, firmware version 1.1.5

Table 50 • Desktop and Kiosk SGD Firmware Compatibility (Continued)

SGD Commands	ZD500R	HC100	G-Series, LP2824 Plus TLP 2824 Plus	GK800, GT800, GK888, GC420d, GC420t	KR403
external_wired.ip.gateway	—	—	V56.15.6Z V61.15.6Z V61.17.3Z	V70.17.11Z V71.17.11Z	—
external_wired.ip.netmask	—	—	V56.15.6Z V61.15.6Z V61.17.3Z	V70.17.11Z V71.17.11Z	—
external_wired.ip.port	—	—	V56.15.6Z V61.15.6Z V61.17.3Z	V70.17.11Z V71.17.11Z	—
external_wired.ip.protocol	—	—	V56.15.6Z V61.15.6Z V61.17.3Z	V70.17.11Z V71.17.11Z	—
external_wired.ip.timeout.enable	—	—	V56.15.6Z V61.15.6Z V61.17.3Z	V70.17.11Z V71.17.11Z	—
external_wired.ip.timeout.value	—	—	V56.15.6Z V61.15.6Z V61.17.3Z	V70.17.11Z V71.17.11Z	—
external_wired.ip.v6.addr	—	—	V56.15.6Z V61.15.6Z V61.17.3Z	V70.17.11Z V71.17.11Z	—
external_wired.ip.v6.gateway	—	—	V56.15.6Z V61.15.6Z V61.17.3Z	V70.17.11Z V71.17.11Z	—
external_wired.ip.v6.prefix_length	—	—	V56.15.6Z V61.15.6Z V61.17.3Z	V70.17.11Z V71.17.11Z	—
external_wired.mac_addr	—	—	V56.15.6Z V61.15.6Z V61.17.3Z	V70.17.11Z V71.17.11Z	—
external_wired.mac_raw	—	—	V56.15.6Z V61.15.6Z V61.17.3Z	V70.17.11Z V71.17.11Z	—
ezpl.head_close_action	V74.19.6Z	—	—	—	—
ezpl.label_length_max	V74.19.6Z	—	—	—	—
ezpl.label_sensor	V74.19.6Z	—	—	—	—
ezpl.manual_calibration	V74.19.6Z	—	—	—	—
ezpl.media_type	V74.19.6Z	—	—	—	—
ezpl.power_up_action	V74.19.6Z	—	—	—	—
ezpl.print_method	V74.19.6Z	—	—	—	—
ezpl.print_width	V74.19.6Z	—	—	—	—
ezpl.reprint_mode	V74.19.6Z	—	—	—	—
ezpl.take_label	V74.19.6Z	—	—	—	—
ezpl.tear_off	V74.19.6Z	—	—	—	—

* On these printers with ZebraNet™ 10/100 Internal Print Server.

** On these printers with ZebraNet™ 10/100 External Print Server, firmware version 1.1.5

Table 50 • Desktop and Kiosk SGD Firmware Compatibility (Continued)

SGD Commands	ZD500R	HC100	G-Series, LP2824 Plus TLP 2824 Plus	GK800, GT800, GK888, GC420d, GC420t	KR403
<i>file.delete</i>	V74.19.6Z	V54.16.1ZC	V56.15.6Z V61.15.6Z V61.17.3Z	V70.17.11Z V71.17.11Z	—
file.dir	V74.19.6Z	V54.16.1ZC	V56.15.6Z V61.15.6Z V61.17.3Z	V70.17.11Z V71.17.11Z	—
file.dir_format	V74.19.6Z	—	—	—	—
file.run	V74.19.6Z	V54.16.1ZC	V56.15.6Z V61.15.6Z V61.17.3Z	V70.17.11Z V71.17.11Z	—
file.type	V74.19.6Z	V54.16.1ZC	V56.15.6Z V61.15.6Z V61.17.3Z	V70.17.11Z V71.17.11Z	—
formats.cancel_all	V74.19.6Z	—	—	—	—
head.latch	V74.19.6Z	V54.16.1ZC	V56.15.6Z V61.15.6Z V61.17.3Z	V70.17.11Z V71.17.11Z	—
input.capture	V74.19.6Z	—	—	—	—
interface.network.active.arp_interval	V74.19.6Z	—	—	—	—
interface.network.active.cable_type	V74.19.6Z	—	—	—	—
interface.network.active.dhcp_received_host_name	V74.19.6Z	—	—	—	—
interface.network.active.gateway	V74.19.6Z	V54.16.1ZC	V56.15.6Z V61.15.6Z V61.17.3Z	V70.17.11Z V71.17.11Z	—
interface.network.active.ip_addr	V74.19.6Z	V54.16.1ZC	V56.15.6Z V61.15.6Z V61.17.3Z	V70.17.11Z V71.17.11Z	—
interface.network.active.mac_addr	V74.19.6Z	V54.16.1ZC	V56.15.6Z V61.15.6Z V61.17.3Z	V70.17.11Z V71.17.11Z	—
interface.network.active.mac_raw	V74.19.6Z	V54.16.1ZC	V56.15.6Z V61.15.6Z V61.17.3Z	V70.17.11Z V71.17.11Z	—
interface.network.active.netmask	V74.19.6Z	V54.16.1ZC	V56.15.6Z V61.15.6Z V61.17.3Z	V70.17.11Z V71.17.11Z	—
interface.network.active.protocol	V74.19.6Z	V54.16.1ZC	V56.15.6Z V61.15.6Z V61.17.3Z	V70.17.11Z V71.17.11Z	—
interface.network.active.protocol_error	V74.19.6Z	—	—	—	—
interface.network.active.rx_errors	V74.19.6Z	—	—	—	—
interface.network.active.rx_packets	V74.19.6Z	—	—	—	—
interface.network.active.server_address	V74.19.6Z	—	—	—	—
interface.network.active.speed	V74.19.6Z	—	—	—	—
interface.network.active.tx_errors	V74.19.6Z	—	—	—	—

* On these printers with ZebraNet™ 10/100 Internal Print Server.

** On these printers with ZebraNet™ 10/100 External Print Server, firmware version 1.1.5

Table 50 • Desktop and Kiosk SGD Firmware Compatibility (Continued)

SGD Commands	ZD500R	HC100	G-Series, LP2824 Plus TLP 2824 Plus	GK800, GT800, GK888, GC420d, GC420t	KR403
interface.network.active.tx_packets	V74.19.6Z	—	—	—	—
interface.network.active.wins_addr	V74.19.6Z	—	—	—	—
internal_wired.auto_switchover	V74.19.6Z	V54.16.1Z	V56.15.6Z V61.15.6Z V61.17.3Z	V70.17.11Z V71.17.11Z	—
internal_wired.ip.addr	V74.19.6Z	V54.16.1Z	V56.15.6Z V61.15.6Z V61.17.3Z	V70.17.11Z V71.17.11Z	—
internal_wired.ip.arp_interval	V74.19.6Z	V54.16.1Z	V56.15.6Z V61.15.6Z V61.17.3Z	V70.17.11Z V71.17.11Z	—
internal_wired.ip.default_addr_enable	V74.19.6Z	V54.16.1Z	V56.15.6Z V61.15.6Z V61.17.3Z	V70.17.11Z V71.17.11Z	—
internal_wired.ip.dhcp.cache_ip	V74.19.6Z	V54.16.1Z	V56.15.6Z V61.15.6Z V61.17.3Z	V70.17.11Z V71.17.11Z	—
internal_wired.ip.dhcp.cid_all	V74.19.6Z	V54.16.1Z	V56.15.6Z V61.15.6Z V61.17.3Z	V70.17.11Z V71.17.11Z	—
internal_wired.ip.dhcp.cid_enable	V74.19.6Z	V54.16.1Z	V56.15.6Z V61.15.6Z V61.17.3Z	V70.17.11Z V71.17.11Z	—
internal_wired.ip.dhcp.cid_prefix	V74.19.6Z	V54.16.1Z	V56.15.6Z V61.15.6Z V61.17.3Z	V70.17.11Z V71.17.11Z	—
internal_wired.ip.dhcp.cid_suffix	V74.19.6Z	V54.16.1Z	V56.15.6Z V61.15.6Z V61.17.3Z	V70.17.11Z V71.17.11Z	—
internal_wired.ip.dhcp.cid_type	V74.19.6Z	V54.16.1Z	V56.15.6Z V61.15.6Z V61.17.3Z	V70.17.11Z V71.17.11Z	—
internal_wired.ip.dhcp.lease.last_attempt	V74.19.6Z	V54.16.1Z	V56.15.6Z V61.15.6Z V61.17.3Z	V70.17.11Z V71.17.11Z	—
internal_wired.ip.dhcp.lease.length	V74.19.6Z	V54.16.1Z	V56.15.6Z V61.15.6Z V61.17.3Z	V70.17.11Z V71.17.11Z	—
internal_wired.ip.dhcp.lease.server	V74.19.6Z	V54.16.1Z	V56.15.6Z V61.15.6Z V61.17.3Z	V70.17.11Z V71.17.11Z	—
internal_wired.ip.dhcp.lease.time_left	V74.19.6Z	V54.16.1Z	V56.15.6Z V61.15.6Z V61.17.3Z	V70.17.11Z V71.17.11Z	—
internal_wired.ip.dhcp.option12	V74.19.6Z	V54.16.1Z	V56.15.6Z V61.15.6Z V61.17.3Z	V70.17.11Z V71.17.11Z	—

* On these printers with ZebraNet™ 10/100 Internal Print Server.

** On these printers with ZebraNet™ 10/100 External Print Server, firmware version 1.1.5

Table 50 • Desktop and Kiosk SGD Firmware Compatibility (Continued)

SGD Commands	ZD500R	HC100	G-Series, LP2824 Plus TLP 2824 Plus	GK800, GT800, GK888, GC420d, GC420t	KR403
internal_wired.ip.dhcp.option12_format	V74.19.6Z	V54.16.1Z	V56.15.6Z V61.15.6Z V61.17.3Z	V70.17.11Z V71.17.11Z	—
internal_wired.ip.dhcp.option12_value	V74.19.6Z	V54.16.1Z	V56.15.6Z V61.15.6Z V61.17.3Z	V70.17.11Z V71.17.11Z	—
internal_wired.ip.dhcp.requests_per_session	V74.19.6Z	V54.16.1Z	V56.15.6Z V61.15.6Z V61.17.3Z	V70.17.11Z V71.17.11Z	—
internal_wired.ip.gateway	V74.19.6Z	V54.16.1Z	V56.15.6Z V61.15.6Z V61.17.3Z	V70.17.11Z V71.17.11Z	—
internal_wired.ip.netmask	V74.19.6Z	V54.16.1Z	V56.15.6Z V61.15.6Z V61.17.3Z	V70.17.11Z V71.17.11Z	—
internal_wired.ip.port	V74.19.6Z	V54.16.1Z	V56.15.6Z V61.15.6Z V61.17.3Z	V70.17.11Z V71.17.11Z	—
internal_wired.ip.port_alternate	V74.19.6Z	—	—	—	—
internal_wired.ip.protocol	V74.19.6Z	V54.16.1Z	V56.15.6Z V61.15.6Z V61.17.3Z	V70.17.11Z V71.17.11Z	—
internal_wired.ip.timeout.enable	V74.19.6Z	V54.16.1Z	V56.15.6Z V61.15.6Z V61.17.3Z	V70.17.11Z V71.17.11Z	—
internal_wired.ip.timeout.value	V74.19.6Z	V54.16.1Z	V56.15.6Z V61.15.6Z V61.17.3Z	V70.17.11Z V71.17.11Z	—
internal_wired.mac_addr	V74.19.6Z	V54.16.1Z	V56.15.6Z V61.15.6Z V61.17.3Z	V70.17.11Z V71.17.11Z	—
internal_wired.mac_raw	V74.19.6Z	V54.16.1Z	V56.15.6Z V61.15.6Z V61.17.3Z	V70.17.11Z V71.17.11Z	—
ip.active_network	V74.19.6Z	V54.16.1Z	V56.16.5Z V61.16.5Z V61.17.3Z	V70.17.11Z V71.17.11Z	—
ip.addr	V74.19.6Z	V54.16.1Z	V56.16.5Z V61.16.5Z V61.17.3Z	V70.17.11Z V71.17.11Z	—
ip.arp_interval	V74.19.6Z	V54.16.1Z	V56.16.5Z V61.16.5Z V61.17.3Z	V70.17.11Z V71.17.11Z	—
ip.bootp.enable	V74.19.6Z	V54.16.1Z	V56.16.5Z V61.16.5Z V61.17.3Z	V70.17.11Z V71.17.11Z	—
ip.dhcp.arp_verify	V74.19.6Z	—	—	—	—
ip.dhcp.auto_provision_enable	V74.19.6Z	—	—	—	—

* On these printers with ZebraNet™ 10/100 Internal Print Server.

** On these printers with ZebraNet™ 10/100 External Print Server, firmware version 1.1.5

Table 50 • Desktop and Kiosk SGD Firmware Compatibility (Continued)

SGD Commands	ZD500R	HC100	G-Series, LP2824 Plus TLP 2824 Plus	GK800, GT800, GK888, GC420d, GC420t	KR403
ip.dhcp.cache_ip	V74.19.6Z	V54.16.1Z	V56.16.5Z V61.16.5Z V61.17.3Z	V70.17.11Z V71.17.11Z	—
ip.dhcp.cid_all	V74.19.6Z	V54.16.1Z	V56.16.5Z V61.16.5Z V61.17.3Z	V70.17.11Z V71.17.11Z	—
ip.dhcp.cid_enable	V74.19.6Z	V54.16.1Z	V56.16.5Z V61.16.5Z V61.17.3Z	V70.17.11Z V71.17.11Z	—
ip.dhcp.cid_prefix	V74.19.6Z	V54.16.1Z	V56.16.5Z V61.16.5Z V61.17.3Z	V70.17.11Z V71.17.11Z	—
ip.dhcp.cid_suffix	V74.19.6Z	V54.16.1Z	V56.16.5Z V61.16.5Z V61.17.3Z	V70.17.11Z V71.17.11Z	—
ip.dhcp.cid_type	V74.19.6Z	V54.16.1Z	V56.16.5Z V61.16.5Z V61.17.3Z	V70.17.11Z V71.17.11Z	—
ip.dhcp.enable	V74.19.6Z	V54.16.1Z	V56.16.5Z V61.16.5Z V61.17.3Z	V70.17.11Z V71.17.11Z	—
ip.dhcp.lease.last_attempt	V74.19.6Z	V54.16.1Z	V56.16.5Z V61.16.5Z V61.17.3Z	V70.17.11Z V71.17.11Z	—
ip.dhcp.lease.server	V74.19.6Z	V54.16.1Z	V56.16.5Z V61.16.5Z V61.17.3Z	V70.17.11Z V71.17.11Z	—
ip.dhcp.lease.time_left	V74.19.6Z	V54.16.1Z	V56.16.5Z V61.16.5Z V61.17.3Z	V70.17.11Z V71.17.11Z	—
ip.dhcp.option12	V74.19.6Z	V54.16.1Z	V56.16.5Z V61.16.5Z V61.17.3Z	V70.17.11Z V71.17.11Z	—
ip.dhcp.option12_format	V74.19.6Z	V54.16.1Z	V56.16.5Z V61.16.5Z V61.17.3Z	V70.17.11Z V71.17.11Z	—
ip.dhcp.option12_value	V74.19.6Z	V54.16.1Z	V56.16.5Z V61.16.5Z V61.17.3Z	V70.17.11Z V71.17.11Z	—
ip.dhcp.request_timeout	V74.19.6Z	V54.16.1Z	V56.16.5Z V61.16.5Z V61.17.3Z	V70.17.11Z V71.17.11Z	—
ip.dhcp.requests_per_session	V74.19.6Z	V54.16.1Z	V56.16.5Z V61.16.5Z V61.17.3Z	V70.17.11Z V71.17.11Z	—
ip.dhcp.session_interval	V74.19.6Z	V54.16.1Z	V56.16.5Z V61.16.5Z V61.17.3Z	V70.17.11Z V71.17.11Z	—
ip.dhcp.vendor_class_id	V74.19.6Z	—	—	—	—

* On these printers with ZebraNet™ 10/100 Internal Print Server.

** On these printers with ZebraNet™ 10/100 External Print Server, firmware version 1.1.5

Table 50 • Desktop and Kiosk SGD Firmware Compatibility (Continued)

SGD Commands	ZD500R	HC100	G-Series, LP2824 Plus TLP 2824 Plus	GK800, GT800, GK888, GC420d, GC420t	KR403
ip.dns.domain	V74.19.6Z	V54.16.1ZC	—	—	—
ip.dns.servers	V74.19.6Z	V54.16.1ZC	—	—	—
ip.ftp.enable	V74.19.6Z	V54.16.1Z	V56.16.5Z V61.16.5Z V61.17.3Z	—	—
ip.ftp.execute_file	V74.19.6Z	V54.16.1Z	V56.16.5Z V61.16.5Z V61.17.3Z	—	—
ip.ftp.request_password	V74.19.6Z	—	—	—	—
ip.gateway	V74.19.6Z	V54.16.1Z	V56.16.5Z V61.16.5Z V61.17.3Z	—	—
ip.http.admin_name	V74.19.6Z	—	—	—	—
ip.http.admin_password	V74.19.6Z	—	—	—	—
ip.http.custom_link_name	V74.19.6Z	—	—	—	—
ip.http.custom_link_url	V74.19.6Z	—	—	—	—
ip.http.enable	V74.19.6Z	V54.16.1Z	V56.16.5Z V61.16.5Z V61.17.3Z	—	—
ip.http.faq_url	V74.19.6Z	—	—	—	—
ip.http.port	V74.19.6Z	—	—	—	—
ip.lpd.enable	V74.19.6Z	V54.16.1Z	V56.15.6Z V61.15.6Z V61.17.3Z	—	—
ip.mac_raw	—	V54.16.1ZC	—	—	—
ip.mirror.appl_path	V74.19.6Z	—	—	—	—
ip.mirror.auto	V74.19.6Z	—	V61.17.3Z V56.17.3Z	V70.17.11Z V71.17.11Z	—
ip.mirror.error_retry	V74.19.6Z	—	V61.17.3Z V56.17.3Z	V70.17.11Z V71.17.11Z	—
ip.mirror.feedback.auto	V74.19.6Z	—	V61.17.3Z V56.17.3Z	V70.17.11Z V71.17.11Z	—
ip.mirror.feedback.freq	V74.19.6Z	—	V61.17.3Z V56.17.3Z	V70.17.11Z V71.17.11Z	—
ip.mirror.feedback.odometer	V74.19.6Z	—	V61.17.3Z V56.17.3Z	V70.17.11Z V71.17.11Z	—
ip.mirror.feedback.path	V74.19.6Z	—	V61.17.3Z V56.17.3Z	V70.17.11Z V71.17.11Z	—
ip.mirror.fetch	V74.19.6Z	—	V61.17.3Z V56.17.3Z	V70.17.11Z V71.17.11Z	—
ip.mirror.freq	V74.19.6Z	—	V61.17.3Z V56.17.3Z	V70.17.11Z V71.17.11Z	—
ip.mirror.freq_hours	V74.19.6Z	—	V61.17.3Z V56.17.3Z	V70.17.11Z V71.17.11Z	—

* On these printers with ZebraNet™ 10/100 Internal Print Server.

** On these printers with ZebraNet™ 10/100 External Print Server, firmware version 1.1.5

Table 50 • Desktop and Kiosk SGD Firmware Compatibility (Continued)

SGD Commands	ZD500R	HC100	G-Series, LP2824 Plus TLP 2824 Plus	GK800, GT800, GK888, GC420d, GC420t	KR403
ip.mirror.last_error	V74.19.6Z	—	V61.17.3Z V56.17.3Z	V70.17.11Z V71.17.11Z	—
ip.mirror.last_time	V74.19.6Z	—	V61.17.3Z V56.17.3Z	V70.17.11Z V71.17.11Z	—
ip.mirror.mode	V74.19.6Z	—	—	—	—
ip.mirror.password	V74.19.6Z	—	V61.17.3Z V56.17.3Z	V70.17.11Z V71.17.11Z	—
ip.mirror.path	V74.19.6Z	—	V61.17.3Z V56.17.3Z	V70.17.11Z V71.17.11Z	—
ip.mirror.reset_delay	V74.19.6Z	—	V61.17.3ZA V56.17.3ZA	V70.17.11Z V71.17.11Z	—
ip.mirror.server	V74.19.6Z	—	V61.17.3Z V56.17.3Z	V70.17.11Z V71.17.11Z	—
ip.mirror.success	V74.19.6Z	—	V61.17.3Z V56.17.3Z	V70.17.11Z V71.17.11Z	—
ip.mirror.success_time	V74.19.6Z	—	V61.17.3Z V56.17.3Z	V70.17.11Z V71.17.11Z	—
ip.mirror.username	V74.19.6Z	—	V61.17.3Z V56.17.3Z	V70.17.11Z V71.17.11Z	—
ip.mirror.version	V74.19.6Z	—	V61.17.3Z V56.17.3Z	V70.17.11Z V71.17.11Z	—
ip.netmask	V74.19.6Z	V54.16.1Z	V56.15.6Z V61.15.6Z V61.17.3Z	V70.17.11Z V71.17.11Z	—
ip.pop3.enable	V74.19.6Z	V54.16.1Z	V56.15.6Z V61.15.6Z V61.17.3Z	V70.17.11Z V71.17.11Z	—
ip.pop3.password	V74.19.6Z	V54.16.1Z	V56.15.6Z V61.15.6Z V61.17.3Z	V70.17.11Z V71.17.11Z	—
ip.pop3.poll	V74.19.6Z	V54.16.1Z	V56.15.6Z V61.15.6Z V61.17.3Z	V70.17.11Z V71.17.11Z	—
ip.pop3.server_addr	V74.19.6Z	V54.16.1Z	V56.15.6Z V61.15.6Z V61.17.3Z	V70.17.11Z V71.17.11Z	—
ip.pop3.username	V74.19.6Z	V54.16.1Z	V56.15.6Z V61.15.6Z V61.17.3Z	V70.17.11Z V71.17.11Z	—
ip.port	V74.19.6Z	V54.16.1Z	V56.15.6Z V61.15.6Z V61.17.3Z	V70.17.11Z V71.17.11Z	—
ip.port_alternate	V74.19.6Z	—	—	—	—
ip.primary_network	V74.19.6Z	—	—	—	—
ip.primary_network	V74.19.6Z	V54.16.1Z	V56.15.6Z V61.15.6Z V61.17.3Z	V70.17.11Z V71.17.11Z	—

* On these printers with ZebraNet™ 10/100 Internal Print Server.

** On these printers with ZebraNet™ 10/100 External Print Server, firmware version 1.1.5

Table 50 • Desktop and Kiosk SGD Firmware Compatibility (Continued)

SGD Commands	ZD500R	HC100	G-Series, LP2824 Plus TLP 2824 Plus	GK800, GT800, GK888, GC420d, GC420t	KR403
ip.smtp.domain	V74.19.6Z	V54.16.1Z	V56.15.6Z V61.15.6Z V61.17.3Z	V70.17.11Z V71.17.11Z	—
ip.smtp.enable	V74.19.6Z	V54.16.1Z	V56.15.6Z V61.15.6Z V61.17.3Z	V70.17.11Z V71.17.11Z	—
ip.smtp.server_addr	V74.19.6Z	V54.16.1Z	V56.15.6Z V61.15.6Z V61.17.3Z	V70.17.11Z V71.17.11Z	—
ip.snmp.enable	V74.19.6Z	V54.16.1Z	V56.15.6Z V61.15.6Z V61.17.3Z	V70.17.11Z V71.17.11Z	—
ip.snmp.get_community_name	V74.19.6Z	V54.16.1Z	V56.15.6Z V61.15.6Z V61.17.3Z	V70.17.11Z V71.17.11Z	—
ip.snmp.set_community_name	V74.19.6Z	V54.16.1Z	V56.15.6Z V61.15.6Z V61.17.3Z	V70.17.11Z V71.17.11Z	—
ip.snmp.trap_community_name	V74.19.6Z	—	—	—	—
ip.tcp.enable	V74.19.6Z	V54.16.1Z	V56.15.6Z V61.15.6Z V61.17.3Z	V70.17.11Z V71.17.11Z	—
ip.telnet.enable	V74.19.6Z	V54.16.1Z	V56.15.6Z V61.15.6Z V61.17.3Z	V70.17.11Z V71.17.11Z	—
ip.udp.enable	V74.19.6Z	V54.16.1Z	V56.15.6Z V61.15.6Z V61.17.3Z	V70.17.11Z V71.17.11Z	—
media.cartridge.part_number	—	V54.16.5Z	—	—	—
media.cut_now	—	—	—	—	V66.17.2Z
media.darkness_mode	—	V54.16.1Z	—	—	—
media.media_low.external	—	—	—	—	V66.17.2Z
media.media_low.warning	—	—	—	—	—
media.present.cut_amount	—	—	—	—	V66.17.2Z
media.present.cut_margin	—	—	—	—	V66.17.2Z
media.present.eject	—	—	—	—	V66.17.2Z
media.present.length_addition	—	—	—	—	V66.17.2Z
media.present.loop_length	—	—	—	—	V66.17.2Z
media.present.loop_length_max	—	—	—	—	V66.17.2Z
media.present.present_timeout	—	—	—	—	V66.17.2Z
media.present.present_type	—	—	—	—	V66.17.2Z
media.printmode	V74.19.6Z	V54.16.1Z	V56.15.6Z V61.15.6Z V61.17.3Z	V70.17.11Z V71.17.11Z	—

* On these printers with ZebraNet™ 10/100 Internal Print Server.

** On these printers with ZebraNet™ 10/100 External Print Server, firmware version 1.1.5

Table 50 • Desktop and Kiosk SGD Firmware Compatibility (Continued)

SGD Commands	ZD500R	HC100	G-Series, LP2824 Plus TLP 2824 Plus	GK800, GT800, GK888, GC420d, GC420t	KR403
media.speed	V74.19.6Z	V54.16.1Z	V56.15.6Z V61.15.6Z V61.17.3Z	V70.17.11Z V71.17.11Z	—
memory.flash_free	V74.19.6Z	V54.16.1Z	V56.15.6Z V61.15.6Z V61.17.3Z	V70.17.11Z V71.17.11Z	V66.17.4Z
memory.flash_size	V74.19.6Z	V54.16.1Z	V56.15.6Z V61.15.6Z V61.17.3Z	V70.17.11Z V71.17.11Z	V66.17.4Z
memory.ram_free	V74.19.6Z	V54.16.1Z	V56.15.6Z V61.15.6Z V61.17.3Z	V70.17.11Z V71.17.11Z	V66.17.4Z
memory.ram_size	V74.19.6Z	V54.16.1Z	V56.15.6Z V61.15.6Z V61.17.3Z	V70.17.11Z V71.17.11Z	V66.17.4Z
netmanage.avalanche.available_port	V74.19.6Z	—	—	—	—
netmanage.avalanche.startup_update	V74.19.6Z	—	—	—	—
netmanage.avalanche.agent_addr	V74.19.6Z	—	—	—	—
netmanage.avalanche.available_agent	V74.19.6Z	—	—	—	—
netmanage.avalanche.encryption_type	V74.19.6Z	—	—	—	—
netmanage.avalanche.interval	V74.19.6Z	—	—	—	—
netmanage.avalanche.interval_update	V74.19.6Z	—	—	—	—
netmanage.avalanche.model_name	V74.19.6Z	—	—	—	—
netmanage.avalanche.set_property	V74.19.6Z	—	—	—	—
netmanage.avalanche.tcp_connection_timeout	V74.19.6Z	—	—	—	—
netmanage.avalanche.text_msg.beep	V74.19.6Z	—	—	—	—
netmanage.avalanche.text_msg.display	V74.19.6Z	—	—	—	—
netmanage.avalanche.text_msg.print	V74.19.6Z	—	—	—	—
netmanage.avalanche.udp_timeout	V74.19.6Z	—	—	—	—
odometer.headclean	V74.19.6Z	V54.16.1Z	V56.15.6Z V61.15.6Z V61.17.3Z	V70.17.11Z V71.17.11Z	—
odometer.headnew	V74.19.6Z	V54.16.1Z	V56.15.6Z V61.15.6Z V61.17.3Z	V70.17.11Z V71.17.11Z	—
odometer.label_dot_length	V74.19.6Z	V54.16.1Z	V56.15.6Z V61.15.6Z V61.17.3Z	V70.17.11Z V71.17.11Z	—
odometer.media_marker_count1	V74.19.6Z	V54.16.1Z	V56.15.6Z V61.15.6Z V61.17.3Z	V70.17.11Z V71.17.11Z	—
odometer.media_marker_count2	V74.19.6Z	V54.16.1Z	V56.15.6Z V61.15.6Z V61.17.3Z	V70.17.11Z V71.17.11Z	—
odometer.retracts_count	—	—	—	—	V66.17.2Z

* On these printers with ZebraNet™ 10/100 Internal Print Server.

** On these printers with ZebraNet™ 10/100 External Print Server, firmware version 1.1.5

Table 50 • Desktop and Kiosk SGD Firmware Compatibility (Continued)

SGD Commands	ZD500R	HC100	G-Series, LP2824 Plus TLP 2824 Plus	GK800, GT800, GK888, GC420d, GC420t	KR403
odometer.rfid.valid_resetable	V74.19.6Z	—	—	—	—
odometer.rfid.void_resetable	V74.19.6Z	—	—	—	—
odometer.total_print_length	V74.19.6Z	V54.16.1Z	V56.15.6Z V61.15.6Z V61.17.3Z	V70.17.11Z V71.17.11Z	—
parallel_port.mode	—	—	—	—	—
parallel_port.present	—	—	—	—	—
power.dtr_power_off	V74.19.6Z	—	—	—	—
print.tone	V74.19.6Z	V54.16.1Z	V56.15.6Z V61.15.6Z V61.17.3Z	V70.17.11Z V71.17.11Z	—
rfid.country_code	V74.19.6Z	—	—	—	—
rfid.enable	V74.19.6Z	—	—	—	—
rfid.error.response	V74.19.6Z	—	—	—	—
rfid.position.program	V74.19.6Z	—	—	—	—
rfid.reader_1.firmware_version	V74.19.6Z	—	—	—	—
rfid.reader_1.hardware_version	V74.19.6Z	—	—	—	—
rfid.reader_1.model	V74.19.6Z	—	—	—	—
rfid.reader_1.power.read	V74.19.6Z	—	—	—	—
rfid.reader_1.power.write	V74.19.6Z	—	—	—	—
rfid.tag.read.content	V74.19.6Z	—	—	—	—
rfid.tag.read.execute	V74.19.6Z	—	—	—	—
rfid.tag.read.result_line1	V74.19.6Z	—	—	—	—
rfid.tag.read.result_line1	V74.19.6Z	—	—	—	—
rfid.tag.read.result_line1_alternate	V74.19.6Z	—	—	—	—
rfid.tag.read.result_line2	V74.19.6Z	—	—	—	—
rfid.tag.read.result_line2_alternate	V74.19.6Z	—	—	—	—
rfid.tag.test.content	V74.19.6Z	—	—	—	—
rfid.tag.test.execute	V74.19.6Z	—	—	—	—
rfid.tag.test.result_line2	V74.19.6Z	—	—	—	—
usb.device.device_id_string	V74.19.6Z	—	—	—	—
usb.device.device_unique_id	V74.19.6Z	—	—	—	—
usb.device.device_version	V74.19.6Z	—	—	—	—
usb.device.manufacturer_string	V74.19.6Z	—	—	—	—
usb.device.product_id	V74.19.6Z	—	—	—	—
usb.device.product_string	V74.19.6Z	—	—	—	—
usb.device.serial_string	V74.19.6Z	—	—	—	—
usb.device.vendor_id	V74.19.6Z	—	—	—	—
usb.halt	V74.19.6Z	—	—	—	—

* On these printers with ZebraNet™ 10/100 Internal Print Server.

** On these printers with ZebraNet™ 10/100 External Print Server, firmware version 1.1.5

Table 50 • Desktop and Kiosk SGD Firmware Compatibility (Continued)

SGD Commands	ZD500R	HC100	G-Series, LP2824 Plus TLP 2824 Plus	GK800, GT800, GK888, GC420d, GC420t	KR403
weblink.ip.conn[1 2].location	V74.19.6Z	—	—	—	—
weblink.ip.conn[1 2].num_connections	V74.19.6Z	—	—	—	—
wlan.11n.20mhz_only	V74.19.6Z	—	—	—	—
wlan.11n.aggregation		—	—	—	—
wlan.11n.greenfield	V74.19.6Z	—	—	—	—
wlan.11n.rifs	V74.19.6Z	—	—	—	—
wlan.11n.short_gi_20mhz	V74.19.6Z	—	—	—	—
wlan.11n.short_gi_40mhz	V74.19.6Z	—	—	—	—
wlan.active_channels	V74.19.6Z	—	—	—	—
wlan.adhocautomode	—	V54.16.1Z	V56.16.5Z V61.16.5Z V61.17.3Z	V70.17.11Z V71.17.11Z	—
wlan.adhocchannel	—	V54.16.1Z	V56.16.5Z V61.16.5Z V61.17.3Z	V70.17.11Z V71.17.11Z	—
wlan.allowed_band	V74.19.6Z	—	—	—	—
wlan.associated	V74.19.6Z	V54.16.1Z	V56.16.5Z V61.16.5Z V61.17.3Z	V70.17.11Z V71.17.11Z	—
wlan.bssid	V74.19.6Z	V54.16.1Z	V56.16.5Z V61.16.5Z V61.17.3Z	V70.17.11Z V71.17.11Z	—
wlan.channel	V74.19.6Z	V54.16.1Z	V56.16.5Z V61.16.5Z V61.17.3Z	V70.17.11Z V71.17.11Z	—
wlan.channel_mask	V74.19.6Z	V54.16.1Z	V56.16.5Z V61.16.5Z V61.17.3Z	V70.17.11Z V71.17.11Z	—
wlan.current_tx_rate	V74.19.6Z	V54.16.1Z	V56.16.5Z V61.16.5Z V61.17.3Z	V70.17.11Z V71.17.11Z	—
wlan.essid	V74.19.6Z	V54.16.1Z	V56.16.5Z V61.16.5Z V61.17.3Z	V70.17.11Z V71.17.11Z	—
wlan.firmware_version	V74.19.6Z	V54.16.1Z	V56.16.5Z V61.16.5Z V61.17.3Z	V70.17.11Z V71.17.11Z	—
wlan.ip.addr	V74.19.6Z	V54.16.1Z	V56.16.5Z V61.16.5Z V61.17.3Z	V70.17.11Z V71.17.11Z	—
wlan.ip.arp_interval	V74.19.6Z	V54.16.1Z	V56.16.5Z V61.16.5Z V61.17.3Z	V70.17.11Z V71.17.11Z	—
wlan.ip.default_addr_enable	V74.19.6Z	V54.16.1Z	V56.16.5Z V61.16.5Z V61.17.3Z	V70.17.11Z V71.17.11Z	—

* On these printers with ZebraNet™ 10/100 Internal Print Server.

** On these printers with ZebraNet™ 10/100 External Print Server, firmware version 1.1.5

Table 50 • Desktop and Kiosk SGD Firmware Compatibility (Continued)

SGD Commands	ZD500R	HC100	G-Series, LP2824 Plus TLP 2824 Plus	GK800, GT800, GK888, GC420d, GC420t	KR403
wlan.ip.dhcp.cache_ip	V74.19.6Z	V54.16.1Z	V56.16.5Z V61.16.5Z V61.17.3Z	V70.17.11Z V71.17.11Z	—
wlan.ip.dhcp.cid_all	V74.19.6Z	V54.16.1Z	V56.16.5Z V61.16.5Z V61.17.3Z	V70.17.11Z V71.17.11Z	—
wlan.ip.dhcp.cid_enable	V74.19.6Z	V54.16.1Z	V56.16.5Z V61.16.5Z V61.17.3Z	V70.17.11Z V71.17.11Z	—
wlan.ip.dhcp.cid_prefix	V74.19.6Z	V54.16.1Z	V56.16.5Z V61.16.5Z V61.17.3Z	V70.17.11Z V71.17.11Z	—
wlan.ip.dhcp.cid_suffix	V74.19.6Z	V54.16.1Z	V56.16.5Z V61.16.5Z V61.17.3Z	V70.17.11Z V71.17.11Z	—
wlan.ip.dhcp.cid_type	V74.19.6Z	V54.16.1Z	V56.16.5Z V61.16.5Z V61.17.3Z	V70.17.11Z V71.17.11Z	—
wlan.ip.dhcp.lease.last_attempt	V74.19.6Z	V54.16.1Z	V56.15.6Z V61.15.6Z V61.17.3Z	V70.17.11Z V71.17.11Z	V66.17.4Z
wlan.ip.dhcp.lease.length	V74.19.6Z	V54.16.1Z	V56.16.5Z V61.16.5Z V61.17.3Z	V70.17.11Z V71.17.11Z	—
wlan.ip.dhcp.lease.server	V74.19.6Z	V54.16.1Z	V56.16.5Z V61.16.5Z V61.17.3Z	V70.17.11Z V71.17.11Z	—
wlan.ip.dhcp.lease.time_left	V74.19.6Z	V54.16.1Z	V56.16.5Z V61.16.5Z V61.17.3Z	V70.17.11Z V71.17.11Z	—
wlan.ip.dhcp.option12	V74.19.6Z	V54.16.1Z	V56.16.5Z V61.16.5Z V61.17.3Z	V70.17.11Z V71.17.11Z	—
wlan.ip.dhcp.option12_format	V74.19.6Z	V54.16.1Z	V56.16.5Z V61.16.5Z V61.17.3Z	V70.17.11Z V71.17.11Z	—
wlan.ip.dhcp.option12_value	V74.19.6Z	V54.16.1Z	V56.16.5Z V61.16.5Z V61.17.3Z	V70.17.11Z V71.17.11Z	—
wlan.ip.dhcp.request_timeout	V74.19.6Z	V54.16.1Z	V56.16.5Z V61.16.5Z V61.17.3Z	V70.17.11Z V71.17.11Z	—
wlan.ip.dhcp.requests_per_session	V74.19.6Z	V54.16.1Z	V56.16.5Z V61.16.5Z V61.17.3Z	V70.17.11Z V71.17.11Z	—
wlan.ip.dhcp.session_interval	V74.19.6Z	V54.16.1Z	V56.16.5Z V61.16.5Z V61.17.3Z	V70.17.11Z V71.17.11Z	—

* On these printers with ZebraNet™ 10/100 Internal Print Server.

** On these printers with ZebraNet™ 10/100 External Print Server, firmware version 1.1.5

Table 50 • Desktop and Kiosk SGD Firmware Compatibility (Continued)

SGD Commands	ZD500R	HC100	G-Series, LP2824 Plus TLP 2824 Plus	GK800, GT800, GK888, GC420d, GC420t	KR403
wlan.ip.gateway	V74.19.6Z	V54.16.1Z	V56.16.5Z V61.16.5Z V61.17.3Z	V70.17.11Z V71.17.11Z	—
wlan.ip.netmask	V74.19.6Z	V54.16.1Z	V56.16.5Z V61.16.5Z V61.17.3Z	V70.17.11Z V71.17.11Z	—
wlan.ip.port	V74.19.6Z	V54.16.1Z	V56.16.5Z V61.16.5Z V61.17.3Z	V70.17.11Z V71.17.11Z	—
wlan.ip.port.alternate	V74.19.6Z	—	—	—	—
wlan.ip.protocol	V74.19.6Z	V54.16.1Z	V56.16.5Z V61.16.5Z V61.17.3Z	V70.17.11Z V71.17.11Z	—
wlan.ip.timeout.enable	V74.19.6Z	V54.16.1Z	V56.16.5Z V61.16.5Z V61.17.3Z	V70.17.11Z V71.17.11Z	—
wlan.ip.timeout.value	V74.19.6Z	V54.16.1Z	V56.16.5Z V61.16.5Z V61.17.3Z	V70.17.11Z V71.17.11Z	—
wlan.keep_alive.enable	V74.19.6Z	V54.16.1Z	V56.16.5Z V61.16.5Z V61.17.3Z	V70.17.11Z V71.17.11Z	—
wlan.keep_alive.timeout	V74.19.6Z	V54.16.1Z	V56.16.5Z V61.16.5Z V61.17.3Z	V70.17.11Z V71.17.11Z	—
wlan.kerberos.kdc	—	V54.16.1Z	V56.16.5Z V61.16.5Z V61.17.3Z	V70.17.11Z V71.17.11Z	—
wlan.kerberos.password	—	V54.16.1Z	V56.16.5Z V61.16.5Z V61.17.3Z	V70.17.11Z V71.17.11Z	—
wlan.kerberos.realm	—	V54.16.1Z	V56.16.5Z V61.16.5Z V61.17.3Z	V70.17.11Z V71.17.11Z	—
wlan.kerberos.username	—	V54.16.1Z	V56.16.5Z V61.16.5Z V61.17.3Z	V70.17.11Z V71.17.11Z	—
wlan.mac_addr	V74.19.6Z	V54.16.1Z	V56.16.5Z V61.16.5Z V61.17.3Z	V70.17.11Z V71.17.11Z	—
wlan.mac_raw	V74.19.6Z	V54.16.1Z	V56.16.5Z V61.16.5Z V61.17.3Z	V70.17.11Z V71.17.11Z	—
wlan.operating_mode	V74.19.6Z	V54.16.1Z	V56.16.5Z V61.16.5Z V61.17.3Z	V70.17.11Z V71.17.11Z	—
wlan.password	V74.19.6Z	V54.16.1Z	V56.16.5Z V61.16.5Z V61.17.3Z	V70.17.11Z V71.17.11Z	—

* On these printers with ZebraNet™ 10/100 Internal Print Server.

** On these printers with ZebraNet™ 10/100 External Print Server, firmware version 1.1.5

Table 50 • Desktop and Kiosk SGD Firmware Compatibility (Continued)

SGD Commands	ZD500R	HC100	G-Series, LP2824 Plus TLP 2824 Plus	GK800, GT800, GK888, GC420d, GC420t	KR403
wlan.permitted_channels	V74.19.6Z	—	—	—	—
wlan.preamble	V74.19.6Z	V54.16.1Z	V56.16.5Z V61.16.5Z V61.17.3Z	V70.17.11Z V71.17.11Z	—
wlan.private_key_password	V74.19.6Z	V54.16.1Z	V56.16.5Z V61.16.5Z V61.17.3Z	V70.17.11Z V71.17.11Z	—
wlan.roam.interchannel_delay	—	V54.16.1Z	V56.16.5Z V61.16.5Z V61.17.3Z	V70.17.11Z V71.17.11Z	—
wlan.roam.interval	—	V54.16.1Z	V56.16.5Z V61.16.5Z V61.17.3Z	V70.17.11Z V71.17.11Z	—
wlan.roam.max_chan_scan_time	—	V54.16.1Z	V56.16.5Z V61.16.5Z V61.17.3Z	V70.17.11Z V71.17.11Z	—
wlan.roam.max_fail	—	—	V61.17.11Z V56.17.11Z	V70.17.11Z V71.17.11Z	—
wlan.roam.rssi	—	—	V61.17.11Z V56.17.11Z	V70.17.11Z V71.17.11Z	—
wlan.roam.signal	—	V54.16.1Z	V56.16.5Z V61.16.5Z V61.17.3Z	V70.17.11Z V71.17.11Z	—
wlan.security	—	V54.16.1Z	V56.16.5Z V61.16.5Z V61.17.3Z	V70.17.11Z V71.17.11Z	—
wlan.signal_noise	—	V54.16.1Z	V56.16.5Z V61.16.5Z V61.17.3Z	V70.17.11Z V71.17.11Z	—
wlan.signal_quality	—	V54.16.1Z	V56.16.5Z V61.16.5Z V61.17.3Z	V70.17.11Z V71.17.11Z	—
wlan.signal_strength	V74.19.6Z	V54.16.1Z	V56.16.5Z V61.16.5Z V61.17.3Z	V70.17.11Z V71.17.11Z	—
wlan.station_name	V74.19.6Z	V54.16.1Z	V56.16.5Z V61.16.5Z V61.17.3Z	V70.17.11Z V71.17.11Z	—
wlan.tx_power	—	V54.16.1Z	V56.16.5Z V61.16.5Z V61.17.3Z	V70.17.11Z V71.17.11Z	—
wlan.tx_rate	V74.19.6Z	V54.16.1Z	V56.16.5Z V61.16.5Z V61.17.3Z	V70.17.11Z V71.17.11Z	—
wlan.user_channel_list	V74.19.6Z	—	—	—	—
wlan.username	V74.19.6Z	V54.16.1Z	V56.16.5Z V61.16.5Z V61.17.3Z	V70.17.11Z V71.17.11Z	—
wlan.waveagent.enable	V74.19.6Z	—	—	—	—

* On these printers with ZebraNet™ 10/100 Internal Print Server.

** On these printers with ZebraNet™ 10/100 External Print Server, firmware version 1.1.5

Table 50 • Desktop and Kiosk SGD Firmware Compatibility (Continued)

SGD Commands	ZD500R	HC100	G-Series, LP2824 Plus TLP 2824 Plus	GK800, GT800, GK888, GC420d, GC420t	KR403
wlan.waveagent.udp_port	V74.19.6Z	—	—	—	—
wlan.wep.auth_type	V74.19.6Z	V54.16.1Z	V56.16.5Z V61.16.5Z V61.17.3Z	V70.17.11Z V71.17.11Z	—
wlan.wep.index	V74.19.6Z	V54.16.1Z	V56.16.5Z V61.16.5Z V61.17.3Z	V70.17.11Z V71.17.11Z	—
wlan.wep.key_format	V74.19.6Z	V54.16.1Z	V56.16.5Z V61.16.5Z V61.17.3Z	V70.17.11Z V71.17.11Z	—
wlan.wep.key1	V74.19.6Z	V54.16.1Z	V56.16.5Z V61.16.5Z V61.17.3Z	V70.17.11Z V71.17.11Z	—
wlan.wep.key2	V74.19.6Z	V54.16.1Z	V56.16.5Z V61.16.5Z V61.17.3Z	V70.17.11Z V71.17.11Z	—
wlan.wep.key3	V74.19.6Z	V54.16.1Z	V56.16.5Z V61.16.5Z V61.17.3Z	V70.17.11Z V71.17.11Z	—
wlan.wep.key4	V74.19.6Z	V54.16.1Z	V56.16.5Z V61.16.5Z V61.17.3Z	V70.17.11Z V71.17.11Z	—
wlan.wpa.psk	V74.19.6Z	V54.16.1Z	V56.16.5Z V61.16.5Z V61.17.3Z	V70.17.11Z V71.17.11Z	—
zbi.control.add_breakpoint	V74.19.6Z	V54.16.1Z	V56.16.5Z V61.16.5Z V61.17.3Z	V70.17.11Z V71.17.11Z	—
zbi.control.break	V74.19.6Z	V54.16.1Z	V56.16.5Z V61.16.5Z V61.17.3Z	V70.17.11Z V71.17.11Z	—
zbi.control.clear_breakpoints	V74.19.6Z	V54.16.1Z	V56.16.5Z V61.16.5Z V61.17.3Z	V70.17.11Z V71.17.11Z	—
zbi.control.delete_breakpoint	V74.19.6Z	V54.16.1Z	V56.16.5Z V61.16.5Z V61.17.3Z	V70.17.11Z V71.17.11Z	—
zbi.control.line_number	V74.19.6Z	V54.16.1Z	V56.16.5Z V61.16.5Z V61.17.3Z	V70.17.11Z V71.17.11Z	—
zbi.control.restart	V74.19.6Z	V54.16.1Z	V56.16.5Z V61.16.5Z V61.17.3Z	V70.17.11Z V71.17.11Z	—
zbi.control.run	V74.19.6Z	V54.16.1Z	V56.16.5Z V61.16.5Z V61.17.3Z	V70.17.11Z V71.17.11Z	—
zbi.control.step	V74.19.6Z	V54.16.1Z	V56.16.5Z V61.16.5Z V61.17.3Z	V70.17.11Z V71.17.11Z	—

* On these printers with ZebraNet™ 10/100 Internal Print Server.

** On these printers with ZebraNet™ 10/100 External Print Server, firmware version 1.1.5

Table 50 • Desktop and Kiosk SGD Firmware Compatibility (Continued)

SGD Commands	ZD500R	HC100	G-Series, LP2824 Plus TLP 2824 Plus	GK800, GT800, GK888, GC420d, GC420t	KR403
<i>zbi.control.terminate</i>	V74.19.6Z	V54.16.1Z	V56.16.5Z V61.16.5Z V61.17.3Z	V70.17.11Z V71.17.11Z	—
<i>zbi.control.variable_name</i>	V74.19.6Z	V54.16.1Z	V56.16.5Z V61.16.5Z V61.17.3Z	V70.17.11Z V71.17.11Z	—
<i>zbi.control.variable_value</i>	V74.19.6Z	V54.16.1Z	V56.16.5Z V61.16.5Z V61.17.3Z	V70.17.11Z V71.17.11Z	—
<i>zbi.key</i>	V74.19.6Z	V54.16.1Z	V56.16.5Z V61.16.5Z V61.17.3Z	V70.17.11Z V71.17.11Z	—
<i>zbi.last_error</i>	V74.19.6Z	V54.16.1Z	V56.16.5Z V61.16.5Z V61.17.3Z	V70.17.11Z V71.17.11Z	—
<i>zbi.reseller_key</i>	V74.19.6Z	V54.16.1Z	V56.16.5Z V61.16.5Z V61.17.3Z	V70.17.11Z V71.17.11Z	—
<i>zbi.revision</i>	V74.19.6Z	V54.16.1Z	V56.16.5Z V61.16.5Z V61.17.3Z	V70.17.11Z V71.17.11Z	—
<i>zbi.running_program_name</i>	V74.19.6Z	V54.16.1Z	V56.16.5Z V61.16.5Z V61.17.3Z	V70.17.11Z V71.17.11Z	—
<i>zbi.start_info.execute</i>	V74.19.6Z	V54.16.1Z	V56.16.5Z V61.16.5Z V61.17.3Z	V70.17.11Z V71.17.11Z	—
<i>zbi.start_info.file_name</i>	V74.19.6Z	V54.16.1Z	V56.16.5Z V61.16.5Z V61.17.3Z	V70.17.11Z V71.17.11Z	—
<i>zbi.start_info.memory_alloc</i>	V74.19.6Z	V54.16.1Z	V56.16.5Z V61.16.5Z V61.17.3Z	V70.17.11Z V71.17.11Z	—
<i>zbi.state</i>	V74.19.6Z	V54.16.1Z	V56.16.5Z V61.16.5Z V61.17.3Z	V70.17.11Z V71.17.11Z	—
<i>zpl.caret</i>	—	—	—	—	—
<i>zpl.control_character</i>	—	—	—	—	—
<i>zpl.delimiter</i>	V74.19.6Z	—	—	—	—
<i>zpl.label_length</i>	V74.19.6Z	—	—	—	—
<i>zpl.left_position</i>	V74.19.6Z	—	—	—	—
<i>zpl.system_error</i>	V74.19.6Z	—	—	—	—
<i>zpl.system_status</i>	V74.19.6Z	—	—	—	—
<i>zpl.zpl_mode</i>	V74.19.6Z	—	—	—	—
<i>zpl.zpl_override</i>	V74.19.6Z	—	—	—	—

* On these printers with ZebraNet™ 10/100 Internal Print Server.

** On these printers with ZebraNet™ 10/100 External Print Server, firmware version 1.1.5

RFID Printers



Important • All the firmware versions noted in [Table 51](#), refer to minimum firmware version required. For non-RFID Table Top printers and Print Engines, see [Table 49](#). For non-RFID Desktop printers, see [Table 50](#).

Once an RFID Ready printer has been reconfigured as a RFID Printer, [Table 51](#) should be used.

For commands not listed in [Table 51](#), refer to [Table 49](#) and [Table 50](#) and compare your firmware version to the Vxx.xx.xx firmware to which it most closely corresponds.

Table 51 • RFID Printer SGD Firmware Compatibility

SGD Commands	R110Xi (UHF) and R170Xi	R110PAX4	R4Mplus	R110Xi HF	RXi4	RZ400/RZ600
<i>card.inserted</i>	R60.15.8Z	R62.15.8Z R63.15.8Z	SP994P SP999F SP1027F SP1056E SP1082F	R65.15.8Z	V53.17.7Z	R53.16.3Z V53.17.7Z
<i>card.mac_addr</i>	R60.15.8Z	R62.15.8Z R63.15.8Z	SP994P SP999F SP1027F SP1056E SP1082F	R65.15.8Z	V53.17.7Z	R53.16.3Z V53.17.7Z
<i>ip.addr</i>	R60.15.8Z	R62.15.8Z R63.15.8Z	SP994P SP999F SP1027F SP1056E SP1082F	R65.15.8Z	V53.17.7Z	R53.16.3Z V53.17.7Z
<i>ip.arp_interval</i>	R60.15.8Z	R62.15.8Z R63.15.8Z	SP994P SP999F SP1027F SP1056E SP1082F	R65.15.8Z	V53.17.7Z	R53.16.3Z V53.17.7Z
<i>ip.bootp.enable</i>	R60.15.8Z	R62.15.8Z R63.15.8Z	SP994P SP999F SP1027F SP1056E SP1082F	R65.15.8Z	V53.17.7Z	R53.16.3Z V53.17.7Z
<i>ip.dhcp.cid_all</i>	R60.15.8Z	R62.15.8Z R63.15.8Z	SP994P SP999F SP1027F SP1056E SP1082F	R65.15.8Z	V53.17.7Z	R53.16.3Z V53.17.7Z
<i>ip.dhcp.cid_enable</i>	R60.15.8Z	R62.15.8Z R63.15.8Z	SP994P SP999F SP1027F SP1056E SP1082F	R65.15.8Z	V53.17.7Z	R53.16.3Z V53.17.7Z
<i>ip.dhcp.cid_prefix</i>	R60.15.8Z	R62.15.8Z R63.15.8Z	SP994P SP999F SP1027F SP1056E SP1082F	R65.15.8Z	V53.17.7Z	R53.16.3Z V53.17.7Z

Table 51 • RFID Printer SGD Firmware Compatibility (Continued)

SGD Commands	R110Xi (UHF) and R170Xi	R110PAX4	R4Mplus	R110Xi HF	RXi4	RZ400/ RZ600
<i>ip.dhcp.cid_suffix</i>	R60.15.8Z	R62.15.8Z R63.15.8Z	SP994P SP999F SP1027F SP1056E SP1082F	R65.15.8Z	V53.17.7Z	R53.16.3Z V53.17.7Z
<i>ip.dhcp.cid_type</i>	R60.15.8Z	R62.15.8Z R63.15.8Z	SP994P SP999F SP1027F SP1056E SP1082F	R65.15.8Z	V53.17.7Z	R53.16.3Z V53.17.7Z
<i>ip.dhcp.enable</i>	R60.15.8Z	R62.15.8Z R63.15.8Z	SP994P SP999F SP1027F SP1056E SP1082F	R65.15.8Z	V53.17.7Z	R53.16.3Z V53.17.7Z
<i>ip.ftp.enable</i>	R60.15.8Z	R62.15.8Z R63.15.8Z	SP994P SP999F SP1027F SP1056E SP1082F	R65.15.8Z	V53.17.7Z	R53.16.3Z V53.17.7Z
<i>ip.gateway</i>	R60.15.8Z	R62.15.8Z R63.15.8Z	SP994P SP999F SP1027F SP1056E SP1082F	R65.15.8Z	V53.17.7Z	R53.16.3Z V53.17.7Z
<i>ip.http.enable</i>	R60.15.8Z	R62.15.8Z R63.15.8Z	SP994P SP999F SP1027F SP1056E SP1082F	R65.15.8Z	V53.17.7Z	R53.16.3Z V53.17.7Z
<i>ip.lpd.enable</i>	R60.15.8Z	R62.15.8Z R63.15.8Z	SP994P SP999F SP1027F SP1056E SP1082F	R65.15.8Z	V53.17.7Z	R53.16.3Z V53.17.7Z
<i>ip.netmask</i>	R60.15.8Z	R62.15.8Z R63.15.8Z	SP994P SP999F SP1027F SP1056E SP1082F	R65.15.8Z	V53.17.7Z	R53.16.3Z V53.17.7Z
<i>ip.pop3.enable</i>	R60.15.8Z	R62.15.8Z R63.15.8Z	SP994P SP999F SP1027F SP1056E SP1082F	R65.15.8Z	V53.17.7Z	R53.16.3Z V53.17.7Z
<i>ip.pop3.password</i>	R60.15.8Z	R62.15.8Z R63.15.8Z	SP994P SP999F SP1027F SP1056E SP1082F	R65.15.8Z	V53.17.7Z	R53.16.3Z V53.17.7Z
<i>ip.pop3.poll</i>	R60.15.8Z	R62.15.8Z R63.15.8Z	SP994P SP999F SP1027F SP1056E SP1082F	R65.15.8Z	V53.17.7Z	R53.16.3Z V53.17.7Z

Table 51 • RFID Printer SGD Firmware Compatibility (Continued)

SGD Commands	R110Xi (UHF) and R170Xi	R110PAX4	R4Mplus	R110Xi HF	RXi4	RZ400/ RZ600
<i>ip.pop3.server_addr</i>	R60.15.8Z	R62.15.8Z R63.15.8Z	SP994P SP999F SP1027F SP1056E SP1082F	R65.15.8Z	V53.17.7Z	R53.16.3Z V53.17.7Z
<i>ip.pop3.username</i>	R60.15.8Z	R62.15.8Z R63.15.8Z	SP994P SP999F SP1027F SP1056E SP1082F	R65.15.8Z	V53.17.7Z	R53.16.3Z V53.17.7Z
<i>ip.port</i>	R60.15.8Z	R62.15.8Z R63.15.8Z	SP994P SP999F SP1027F SP1056E SP1082F	R65.15.8Z	V53.17.7Z	R53.16.3Z V53.17.7Z
<i>ip.primary_network</i>	R60.15.8Z	R62.15.8Z R63.15.8Z	SP994P SP999F SP1027F SP1056E SP1082F	R65.15.8Z	V53.17.7Z	R53.16.3Z V53.17.7Z
<i>ip.smtp.domain</i>	R60.15.8Z	R62.15.8Z R63.15.8Z	SP994P SP999F SP1027F SP1056E SP1082F	R65.15.8Z	V53.17.7Z	R53.16.3Z V53.17.7Z
<i>ip.smtp.enable</i>	R60.15.8Z	R62.15.8Z R63.15.8Z	SP994P SP999F SP1027F SP1056E SP1082F	R65.15.8Z	V53.17.7Z	R53.16.3Z V53.17.7Z
<i>ip.smtp.server_addr</i>	R60.15.8Z	R62.15.8Z R63.15.8Z	SP994P SP999F SP1027F SP1056E SP1082F	R65.15.8Z	V53.17.7Z	R53.16.3Z V53.17.7Z
<i>ip.snmp.enable</i>	R60.15.8Z	R62.15.8Z R63.15.8Z	SP994P SP999F SP1027F SP1056E SP1082F	R65.15.8Z	V53.17.7Z	R53.16.3Z V53.17.7Z
<i>ip.snmp.get_community_name</i>	R60.15.8Z	R62.15.8Z R63.15.8Z	SP994P SP999F SP1027F SP1056E SP1082F	R65.15.8Z	V53.17.7Z	R53.16.3Z V53.17.7Z
<i>ip.snmp.set_community_name</i>	R60.15.8Z	R62.15.8Z R63.15.8Z	SP994P SP999F SP1027F SP1056E SP1082F	R65.15.8Z	V53.17.7Z	R53.16.3Z V53.17.7Z
<i>ip.tcp.enable</i>	R60.15.8Z	R62.15.8Z R63.15.8Z	SP994P SP999F SP1027F SP1056E SP1082F	R65.15.8Z	V53.17.7Z	R53.16.3Z V53.17.7Z

Table 51 • RFID Printer SGD Firmware Compatibility (Continued)

SGD Commands	R110Xi (UHF) and R170Xi	R110PAX4	R4Mplus	R110Xi HF	RXi4	RZ400/RZ600
<i>ip.telnet.enable</i>	R60.15.8Z	R62.15.8Z R63.15.8Z	SP994P SP999F SP1027F SP1056E SP1082F	R65.15.8Z	V53.17.7Z	R53.16.3Z V53.17.7Z
<i>ip.udp.enable</i>	R60.15.8Z	R62.15.8Z R63.15.8Z	SP994P SP999F SP1027F SP1056E SP1082F	R65.15.8Z	V53.17.7Z	R53.16.3Z V53.17.7Z
<i>media.printmode</i>	—	—	—	—	V53.17.7Z	R53.16.3Z V53.17.7Z
<i>odometer.rfid.valid_resettable</i>	—	—	—	—	V53.17.7Z	R53.16.3Z V53.17.7Z
<i>odometer.rfid.void_resettable</i>	—	—	—	—	V53.17.7Z	R53.16.3Z V53.17.7Z
<i>rfid.error.response</i>	R60.15.8Z	R62.15.8Z R63.15.8Z	SP994P SP999F SP1027F SP1056E SP1082F	R65.15.8Z	V53.17.7Z	R53.16.3Z V53.17.7Z
<i>rfid.position.program</i>	R60.15.8Z	R62.15.8Z R63.15.8Z	SP994P SP999F SP1027F SP1056E SP1082F	R65.15.8Z	V53.17.7Z	R53.16.3Z V53.17.7Z
<i>rfid.reader_1.antenna_port</i>	R60.15.8Z	R62.15.8Z R63.15.8Z	SP994P SP999F SP1027F SP1056E SP1082F	R65.15.8Z	V53.17.7Z	R53.16.3Z V53.17.7Z
<i>rfid.reader_1.power.read</i>	R60.15.8Z	R62.15.8Z R63.15.8Z	SP994P SP999F SP1027F SP1056E SP1082F	R65.15.8Z	V53.17.7Z	R53.16.3Z V53.17.7Z
<i>rfid.reader_1.power.single_power</i>	R60.15.8Z	R62.15.8Z R63.15.8Z	SP994P SP999F SP1027F SP1056E SP1082F	R65.15.8Z	V53.17.7Z	R53.16.3Z V53.17.7Z
<i>rfid.reader_1.power.write</i>	R60.15.8Z	R62.15.8Z R63.15.8Z	SP994P SP999F SP1027F SP1056E SP1082F	R65.15.8Z	V53.17.7Z	R53.16.3Z V53.17.7Z
<i>rfid.tag.calibrate</i>	R60.15.8Z	R62.15.8Z R63.15.8Z	SP994P SP999F SP1027F SP1056E SP1082F	R65.15.8Z	V53.17.7Z	R53.16.3Z V53.17.7Z

Table 51 • RFID Printer SGD Firmware Compatibility (Continued)

SGD Commands	R110Xi (UHF) and R170Xi	R110PAX4	R4Mplus	R110Xi HF	RXi4	RZ400/ RZ600
<i>rfid.tag.data</i>	R60.15.8Z	R62.15.8Z R63.15.8Z	SP994P SP999F SP1027F SP1056E SP1082F	R65.15.8Z	V53.17.7Z	R53.16.3Z V53.17.7Z
<i>rfid.tag.test</i>	R60.15.8Z	R62.15.8Z R63.15.8Z	SP994P SP999F SP1027F SP1056E SP1082F	R65.15.8Z	V53.17.7Z	R53.16.3Z V53.17.7Z
<i>rfid.tag.type</i>	R60.15.8Z	R62.15.8Z R63.15.8Z	SP994P SP999F SP1027F SP1056E SP1082F	R65.15.8Z	V53.17.7Z	R53.16.3Z V53.17.7Z
<i>wlan.adhocautomode</i>	R60.15.8Z	R62.15.8Z R63.15.8Z	SP994P SP999F SP1027F SP1056E SP1082F	R65.15.8Z	V53.17.7Z	R53.16.3Z V53.17.7Z
<i>wlan.adhocchannel</i>	R60.15.8Z	R62.15.8Z R63.15.8Z	SP994P SP999F SP1027F SP1056E SP1082F	R65.15.8Z	V53.17.7Z	R53.16.3Z V53.17.7Z
<i>wlan.associated</i>	R60.15.8Z	R62.15.8Z R63.15.8Z	SP994P SP999F SP1027F SP1056E SP1082F	R65.15.8Z	V53.17.7Z	R53.16.3Z V53.17.7Z
<i>wlan.channel_mask</i>	R60.15.8Z	R62.15.8Z R63.15.8Z	SP994P SP999F SP1027F SP1056E SP1082F	R65.15.8Z	V53.17.7Z	R53.16.3Z V53.17.7Z
<i>wlan.essid</i>	R60.15.8Z	R62.15.8Z R63.15.8Z	SP994P SP999F SP1027F SP1056E SP1082F	R65.15.8Z	V53.17.7Z	R53.16.3Z V53.17.7Z
<i>wlan.firmware_version</i>	R60.15.8Z	R62.15.8Z R63.15.8Z	SP994P SP999F SP1027F SP1056E SP1082F	R65.15.8Z	V53.17.7Z	R53.16.3Z V53.17.7Z
<i>wlan.keep_alive.enable</i>	R60.15.8Z	R62.15.8Z R63.15.8Z	SP994P SP999F SP1027F SP1056E SP1082F	R65.15.8Z	V53.17.7Z	R53.16.3Z V53.17.7Z
<i>wlan.keep_alive.timeout</i>	R60.15.8Z	R62.15.8Z R63.15.8Z	SP994P SP999F SP1027F SP1056E SP1082F	R65.15.8Z	V53.17.7Z	R53.16.3Z V53.17.7Z

Table 51 • RFID Printer SGD Firmware Compatibility (Continued)

SGD Commands	R110Xi (UHF) and R170Xi	R110PAX4	R4Mplus	R110Xi HF	RXi4	RZ400/ RZ600
<i>wlan.kerberos.kdc</i>	R60.15.8Z	R62.15.8Z R63.15.8Z	SP994P SP999F SP1027F SP1056E SP1082F	R65.15.8Z	V53.17.7Z	R53.16.3Z V53.17.7Z
<i>wlan.kerberos.password</i>	R60.15.8Z	R62.15.8Z R63.15.8Z	SP994P SP999F SP1027F SP1056E SP1082F	R65.15.8Z	V53.17.7Z	R53.16.3Z V53.17.7Z
<i>wlan.kerberos.realm</i>	R60.15.8Z	R62.15.8Z R63.15.8Z	SP994P SP999F SP1027F SP1056E SP1082F	R65.15.8Z	V53.17.7Z	R53.16.3Z V53.17.7Z
<i>wlan.kerberos.username</i>	R60.15.8Z	R62.15.8Z R63.15.8Z	SP994P SP999F SP1027F SP1056E SP1082F	R65.15.8Z	V53.17.7Z	R53.16.3Z V53.17.7Z
<i>wlan.operating_mode</i>	R60.15.8Z	R62.15.8Z R63.15.8Z	SP994P SP999F SP1027F SP1056E SP1082F	R65.15.8Z	V53.17.7Z	R53.16.3Z V53.17.7Z
<i>wlan.password</i>	R60.15.8Z	R62.15.8Z R63.15.8Z	SP994P SP999F SP1027F SP1056E SP1082F	R65.15.8Z	V53.17.7Z	R53.16.3Z V53.17.7Z
<i>wlan.preamble</i>	R60.15.8Z	R62.15.8Z R63.15.8Z	SP994P SP999F SP1027F SP1056E SP1082F	R65.15.8Z	V53.17.7Z	R53.16.3Z V53.17.7Z
<i>wlan.private_key_password</i>	R60.15.8Z	R62.15.8Z R63.15.8Z	SP994P SP999F SP1027F SP1056E SP1082F	R65.15.8Z	V53.17.7Z	R53.16.3Z V53.17.7Z
<i>wlan.roam.interval</i>	R60.15.8Z	R62.15.8Z R63.15.8Z	SP994P SP999F SP1027F SP1056E SP1082F	R65.15.8Z	V53.17.7Z	R53.16.3Z V53.17.7Z
<i>wlan.roam.signal</i>	R60.15.8Z	R62.15.8Z R63.15.8Z	SP994P SP999F SP1027F SP1056E SP1082F	R65.15.8Z	V53.17.7Z	R53.16.3Z V53.17.7Z
<i>wlan.security</i>	R60.15.8Z	R62.15.8Z R63.15.8Z	SP994P SP999F SP1027F SP1056E SP1082F	R65.15.8Z	V53.17.7Z	R53.16.3Z V53.17.7Z

Table 51 • RFID Printer SGD Firmware Compatibility (Continued)

SGD Commands	R110Xi (UHF) and R170Xi	R110PAX4	R4Mplus	R110Xi HF	RXi4	RZ400/ RZ600
<i>wlan.signal_noise</i>	R60.15.8Z	R62.15.8Z R63.15.8Z	SP994P SP999F SP1027F SP1056E SP1082F	R65.15.8Z	V53.17.7Z	R53.16.3Z V53.17.7Z
<i>wlan.signal_quality</i>	R60.15.8Z	R62.15.8Z R63.15.8Z	SP994P SP999F SP1027F SP1056E SP1082F	R65.15.8Z	V53.17.7Z	R53.16.3Z V53.17.7Z
<i>wlan.signal_strength</i>	R60.15.8Z	R62.15.8Z R63.15.8Z	SP994P SP999F SP1027F SP1056E SP1082F	R65.15.8Z	V53.17.7Z	R53.16.3Z V53.17.7Z
<i>wlan.station_name</i>	R60.15.8Z	R62.15.8Z R63.15.8Z	SP994P SP999F SP1027F SP1056E SP1082F	R65.15.8Z	V53.17.7Z	R53.16.3Z V53.17.7Z
<i>wlan.tx_power</i>	R60.15.8Z	R62.15.8Z R63.15.8Z	SP994P SP999F SP1027F SP1056E SP1082F	R65.15.8Z	V53.17.7Z	R53.16.3Z V53.17.7Z
<i>wlan.tx_rate</i>	R60.15.8Z	R62.15.8Z R63.15.8Z	SP994P SP999F SP1027F SP1056E SP1082F	R65.15.8Z	V53.17.7Z	R53.16.3Z V53.17.7Z
<i>wlan.username</i>	R60.15.8Z	R62.15.8Z R63.15.8Z	SP994P SP999F SP1027F SP1056E SP1082F	R65.15.8Z	V53.17.7Z	R53.16.3Z V53.17.7Z
<i>wlan.wep.auth_type</i>	R60.15.8Z	R62.15.8Z R63.15.8Z	SP994P SP999F SP1027F SP1056E SP1082F	R65.15.8Z	V53.17.7Z	R53.16.3Z V53.17.7Z
<i>wlan.wep.index</i>	R60.15.8Z	R62.15.8Z R63.15.8Z	SP994P SP999F SP1027F SP1056E SP1082F	R65.15.8Z	V53.17.7Z	R53.16.3Z V53.17.7Z
<i>wlan.wep.key_format</i>	R60.15.8Z	R62.15.8Z R63.15.8Z	SP994P SP999F SP1027F SP1056E SP1082F	R65.15.8Z	V53.17.7Z	R53.16.3Z V53.17.7Z
<i>wlan.wep.key1</i>	R60.15.8Z	R62.15.8Z R63.15.8Z	SP994P SP999F SP1027F SP1056E SP1082F	R65.15.8Z	V53.17.7Z	R53.16.3Z V53.17.7Z

Table 51 • RFID Printer SGD Firmware Compatibility (Continued)

SGD Commands	R110Xi (UHF) and R170Xi	R110PAX4	R4Mplus	R110Xi HF	RXi4	RZ400/ RZ600
<i>wlan.wep.key2</i>	R60.15.8Z	R62.15.8Z R63.15.8Z	SP994P SP999F SP1027F SP1056E SP1082F	R65.15.8Z	V53.17.7Z	R53.16.3Z V53.17.7Z
<i>wlan.wep.key3</i>	R60.15.8Z	R62.15.8Z R63.15.8Z	SP994P SP999F SP1027F SP1056E SP1082F	R65.15.8Z	V53.17.7Z	R53.16.3Z V53.17.7Z
<i>wlan.wep.key4</i>	R60.15.8Z	R62.15.8Z R63.15.8Z	SP994P SP999F SP1027F SP1056E SP1082F	R65.15.8Z	V53.17.7Z	R53.16.3Z V53.17.7Z
<i>wlan.wpa.psk</i>	R60.15.8Z	R62.15.8Z R63.15.8Z	SP994P SP999F SP1027F SP1056E SP1082F	R65.15.8Z	V53.17.7Z	R53.16.3Z V53.17.7Z

Firmware Features

This appendix covers features added to major firmware releases.

Firmware x.17



Identifies features that are available in printers with firmware version Vx.17.x or later.

The following is an overview of the new and enhanced features available in firmware version V53.17.x, V56.17.xZ, V60.17.x, V61.17.xZ, and later.

Mirror

Mirror is a feature that gives you the ability to:

- Centrally manage and monitor the deployment of your Zebra printers
- Centrally configure and maintain your Zebra printers through remote updates
- Remotely monitor printer updates – via the “Feedback” feature
- There are several Set/Get/Do (SGD) commands that can initiate Mirror. For details see *Mirror Printer Configuration on page 1330*.

Benefits

- When using Mirror, updating the configuration and firmware on the printer is remotely managed from a centralized FTP server. Configurations can be uniformly deployed to individual printers or to groups of printers. Unique configurations can also be targeted to printers as needed. Through the “Feedback” feature, Administrators can easily log and monitor configuration updates on a printer-by-printer basis. Typical uses of Mirror include:
- Configuring printers as they are first received.
- Performing scheduled maintenance updates, sending firmware, fonts, graphics and other objects to the printer as needed.
- Changing printer configurations in order to move printers from one role to another.
- Supported printers and print servers:

Printer	Print Servers
Xi4™ -series	<ul style="list-style-type: none"> • Internal, Integrated 10/100 IPV4 wired • Internal Wireless Plus
ZM400™	<ul style="list-style-type: none"> • Internal, Integrated 10/100 IPV4 wired • Internal Wireless Plus
ZM600™	<ul style="list-style-type: none"> • Internal, Integrated 10/100 IPV4 wired • Internal Wireless Plus
S4M™	<ul style="list-style-type: none"> • Internal Wireless Plus

Print Servers connected to the parallel port, either externally or internally, are not supported for Mirror use.

Wireless Markup Language (WML)

WML offers a text-based method of designing customized menus on the LCD front panel of selected printers. By leveraging Set-Get-Do (SGD) and Zebra Programming Language (ZPL) commands, menus that feature both display and command features can be created. The WML “card” structure makes it possible to link from one menu screen to another, creating menus that are as many levels “deep” as desired or reduced to only those options needed by the printer operator.

Firmware x.16



Identifies features that are available in printers with firmware version V60.16.x, V53.16.x, or later.

The following is an overview of the new and enhanced features available in firmware version V53.16.x and V60.16.x, and later; it is ZBI 2.0-Ready. These include:

- ZBI 2.0 can be enabled by placing a ZBI 2.0 key on the printer via the ZBI Key Manager & Downloader utility. Printers can be ordered from the factory with the ZBI 2.0 option enabled. Printers can be ZBI-Enabled in the field by purchasing and using a ZBI Key Kit. Printers can be ZBI-Enabled in the field by purchasing a key at www.zebrasoftware.com.
- Printers which have been ZBI-Enabled will not display a “Z” at the end of the firmware version string. For example, a printer which has been ZBI-Enabled will display the firmware version as “V53.16.1”, while a printer which has not been ZBI-Enabled will display the firmware version as “V53.16.1Z”
- The printer configuration label will display the ZBI status for the printer:
 - ZBI-Enabled

```

|| ENABLED..... ZBI
|| 2.0..... ZBI VERSION
|| READY..... ZBI STATUS
    
```

- Not ZBI-Enabled

```

|| DISABLED..... ZBI
|| 2.0..... ZBI VERSION
    
```

- The printer configuration label will list which ZBI program is running.

```

|| ENABLED..... ZBI
|| 2.0..... ZBI VERSION
|| CHOICES.BAS..... ZBI STATUS
    
```

- ZBI 2.0 is backwards compatible with previous versions of ZBI. Any code which was specifically written to handle a maximum string length of 255 characters will need to be reviewed to ensure it works with unlimited string lengths.
- Other ZBI 2.0 Features:
 - List ZBI programs from the front panel
 - Start/Stop ZBI programs from the front panel

- Button presses on front panel can be registered as events in ZBI programs.
- Applicator port control
- Support for longer strings, the length of the string dependent on available memory.
- Support for NULL values in Strings and String operations
- SNMP & Set/Get/Do (SGD) Control of ZBI
- On-printer Debugging (via ZBI-Developer)
- ZBI 2.0 Program Encryption
- ZBI 2.0 programs can be made hidden and/or persistent
- New ZBI 2.0 Commands:

ACCEPT	INTTOHEXS
ADDBREAK	READ
AUXPORT_GETPIN	REGISTEREVENTS
AUXPORT_RELEASEPIN	SERVERSOCKET
AUXPORT_SETPIN	SPLIT
AUXPORT_STEALPIN	SPLITCOUNT
CLIENTSOCKET	SUB
CLOSE ALL	TCPX
DELBREAK	TRIGGEREVENT
HANDLEEVENT	UNREGISTEREVENTS
HEXTOINT	WRITE

Firmware x.15



Identifies features that are available in printers with firmware version V60.15.x, V50.15.x, or later.

The following is an overview of the new and enhanced features available in firmware version V60.15.x, V50.15.x, or later. These include:

- Additional wireless securities
- New and updated ZPL commands (including wireless commands)
- Extended SNMP features, providing SNMP based control over commonly-needed printer settings.
- Support for Set / Get / Do (SGD) commands

Wireless Securities

Firmware V60.15.x and V50.15.x offer support for a wider range of wireless securities. These are the supported wireless securities:

- WEP-40-BIT
- WEP-128-BIT
- EAP-TLS
- EAP-TTLS
- EAP-FAST
- PEAP
- LEAP
- WPA-PSK
- WPA EAP-TLS
- WPA EAP-TTLS
- WPA EAP-FAST
- WPA PEAP
- WPA LEAP
- KERBEROS*

* Use of any given wireless security is dependent on the RF card being used.

ZPL and SGD Commands

[Table 52](#) identifies the new commands and updates to existing commands in firmware version V60.15.x, V50.15.x, or later. The bolded items are either new commands or new enhancements to existing commands.

Table 52 • x.15 Features in Detail

Command	Details
^KC	The ^KC command is a new command with firmware version V60.15.x, V50.15.x, or later. It allows wireless print servers to have their own client identifier (CID). When the print server is active is uses the CID on the printer. When both print servers are active they have the option to use the CID on the printer, or their own CID.
~DY	Firmware version V60.15.x, V50.15.x, or later supports .NRD (non readable file) files and .PAC files (protected access credential).
~WS	Firmware version V60.15.x, V50.15.x, or later added these new parameters: <ul style="list-style-type: none"> wireless pulse—adds a pulse to the network traffic generated by the printer. To keep the printer online, a pulse is necessary with some network configurations. wireless pulse interval—when the wireless pulse feature is enabled this sets the interval at which the wireless pulse is sent. channel mask—for commonly used channel masks. international mode—disables or enables International mode
^WX	The ^WX command configures the wireless security settings for printers using the wireless print server.

SNMP

Firmware V60.15.x, V50.15.x, or later feature support for an extended Management Information Base (MIB) file. The extended support now covers many of the printer settings, such as darkness, media type, and other printer specific settings. The MIB file can be downloaded from www.zebra.com for use with SNMP management systems.

Set / Get / Do Support

Printers with firmware V60.15.x and V50.15.x support a new set of commands known as Set / Get / Do (SGD) commands. These commands allow you to configure and get status on the wireless settings in the printer. For details on the supported commands, see *SGD Printer Commands on page 631*.

XML-Enabled Printing

Printers with firmware V60.15.8Z, V53.15.8Z, or later support XML-Enabled printing. For details, go to <http://www.zebra.com/xml>. This new feature does not alter the ZPL capabilities of the printer.

Firmware x.14



Identifies features that are available in printers with firmware version V60.14.x, V50.14.x, or later.

Table 53 identifies the new commands and enhancements to existing commands in firmware V60.14.x, V50.14.x, or later. The bolded items are either new commands or new enhancements to existing commands.

Table 53 • x.14 Features in Detail

Command	Details
<code>^CI</code>	<p>The <code>^CI</code> command selects the encoding and character set. To identify the encoding, include a <code>^CI</code> in the ZPL script. These encodings are now supported with the <code>^CI</code> command:</p> <p>These are new variables that were added to the desired character set or a parameter of the existing <code>^CI</code> command:</p> <ul style="list-style-type: none"> • Big 5 HKSCS (<code>^CI26</code>) with <code>BIGHK.DAT</code>. This supports the Hong Kong supplementary character set of the Big 5 character set and encoding. You can download the Big 5 HKSCS DAT table from www.zebra.com. • Code Page 1252 (<code>^CI27</code>). The <code>^CI27</code> command supports code page 1252. • GB 18030 (<code>^CI26</code>) with <code>GB18030.DAT</code>. This supports the GB 18030 character set and encoding standard. • Unicode Support. These new values were added to the <code>^CI</code> command: <ul style="list-style-type: none"> <code>28</code> = Unicode (UTF-8 encoding) <code>29</code> = Unicode (UTF-16 Big-Endian encoding) <code>30</code> = Unicode (UTF-16 Little-Endian encoding)
<code>~DY</code>	<p>The <code>~DY</code> command downloads fonts to the printer. Firmware version V60.14.x, V50.14.x, or later improves support for TrueType fonts and adds support for TrueType Extension fonts. When OpenType fonts can be downloaded as a TrueType font they are supported.</p>
<code>^FH</code>	<p>The <code>^FH</code> command allows you to enter the hexadecimal value for any character directly into the <code>^FD</code> statement. It has been updated to function with Unicode encodings.</p>
<code>^FL</code>	<p>The <code>^FL</code> command provides the ability to link any TrueType font, including private character fonts to associated fonts, such that if the base font does not have a glyph for the required character, the printer looks to the linked fonts for the glyph. The font links are user-definable.</p>
<code>^FO</code> , <code>^FT</code> , <code>^FW</code>	<p>In firmware version earlier than V60.15.x, V50.15.x or later, the <code>^FO</code> and <code>^FT</code> commands were left-justified. In firmware version V60.14.x, V50.14.x, or later, a new parameter supports right- and auto-justification. Using the <code>^FW</code> command allows you to set justification options.</p>
<code>^HT</code>	<p>Over a communication port, the <code>^HT</code> command receives the complete list of the font links.</p>

Table 53 • x.14 Features in Detail

Command	Details
^LF	The ^LF command prints out a list of the linked fonts.
^PA	<p>The Advanced Text Layout Options command (^PA) is new in firmware version V60.14.x, V50.14.x, or later.</p> <p>Advanced text layout, such as bidirectional text layout, character shaping, and OpenType support, can be activated with the ^PA command. The glyph displayed when the character is missing from a font (default glyph) can be changed from a space character to the default glyph of a font, which is often a square box.</p>
^SL	A new parameter was added to the ^SL command to support the Japanese language in the Real Time Clock feature set.
^TB	The text block (^TB) command is a new command in firmware version V60.14.x, V50.14.x, or later. The ^FB command allows you to print text into a defined block type format; it does not support complex text layout. In contrast, the ^TB command supports a text block with complex text.

Global Printing Solution

The Global Printing solution greatly simplifies international character label printing by supporting Unicode compatible fonts and encoding (UTF-8, UTF-16BE and UTF-16LE) directly in its printers.

These are new and enhanced features available in firmware version V60.14.x, v50,14.x, or later:

- Advanced text layout options
- Big 5 HKSCS
- GB 18030
- Unicode support (UTF-8 and UTF-16)
- Code Page 1252
- Field hexadecimal
- Field origin justification
- Font linking
- Improved font support
- Real-time clock – Japanese support
- Text block

For details on these new features, see [Table 52 on page 1314](#).

Zebra firmware V60.14.x, V50.14.x, or later continues to support locale-specific encoding formats. These formats include:

- Code Page 850
- Shift JIS
- GB
- Unified Hangul Code
- Big 5

What Is Unicode?

Unicode is a universal code page (which converts numeric codes into characters) that can be used with many computer platforms and software applications. While ASCII and other traditional code page encoding systems support 256 characters or less, Unicode can support almost 100,000 characters for all major languages. The languages include complex non-Western languages that can be difficult to print.

Unicode encoding and supporting fonts allow the printer to seamlessly output in any language. As a result, you do not have to select the language, font, code page, or configure or adjust the printer. Zebra's printer-resident capabilities provide fast label output and seamless multi-language printing.

You can create private libraries of logos and special characters and include them in labels. The ability to create custom characters is valuable for creating shipping labels for Asia, as many Asian fonts don't support characters for names, street names, and other proper nouns. Firmware V60.14.x, V50.14.x, or later offers features that support bidirectional printing or complex text layout, including:

- Arabic
- Hindi
- Thai
- Vietnamese
- Other languages

Mirror

This section provides an overview of Mirror, details on how to use it, and configuration examples.

Contents

Mirror Overview	1320
Professional Services for Mirror Configuration.	1321
Requirements.	1322
How Mirror Works	1324
Creating ZPL Files for Use in the "<update-root>/files" Directory	1326
Configuration	1330
The Feedback.get File	1331
How to Set Up and Use Mirror	1333
Troubleshooting	1335

Mirror Overview

Mirror is a feature that gives you the ability to:

- Centrally manage and monitor the deployment of your Zebra printers
- Centrally configure and maintain your Zebra printers through remote updates
- Remotely monitor printer updates - via the "Feedback" feature

There are several Set/Get/Do (SGD) commands that are used to configure and initiate Mirror. For details see, [Mirror Printer Configuration on page 1330](#).

Benefits

When using Mirror, updating the configuration and firmware on the printer is remotely managed from a centralized FTP server. Configurations can be uniformly deployed to individual printers or to groups of printers. Unique Configurations can also be targeted to printers as needed.

Through the "Feedback" feature, Administrators can easily log and monitor configuration updates on a printer-by-printer basis.

Typical uses of Mirror include:

- configuring printers as they are first received
- performing scheduled maintenance updates, sending firmware, fonts, graphics and other objects to the printer as needed
- changing printer Configurations in order to move printers from one role to another

[Figure 11](#) provides an illustration of Mirroring.

Figure 11 • Mirror Illustration

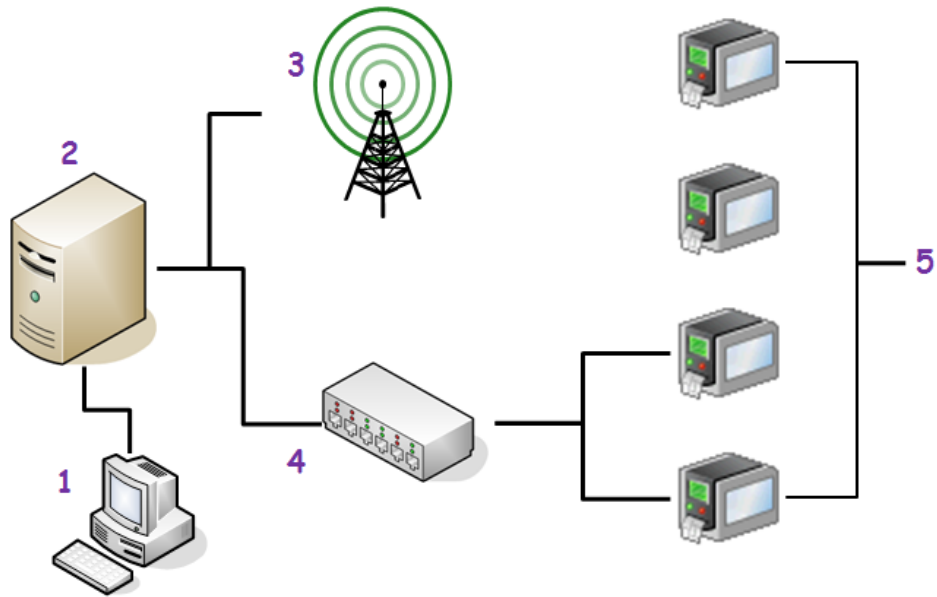

1	Workstation — sends SGD commands to the printer to configure it for Mirror use.
2	FTP Server — Stores configuration files and responds to Mirror requests from the printer. Receives and stores “Feedback” content.
3	Access Point — wireless network infrastructure
4	Hub — wired network infrastructure
5	Zebra Printer(s) — Configured using SGD commands. Sends Mirror requests to the FTP server to receive files. Transmits “Feedback” content to the FTP server to log Mirror event transactions and resulting printer settings.

Professional Services for Mirror Configuration

Zebra offers a Professional Services group that can help with the configuring the Mirror feature. To inquire about Zebra's Professional Services, please contact your Zebra account representative.

Requirements

These are the requirements for Mirror:

- Zebra printer loaded with Mirror capable firmware and Print Server. For details, see [Table 54, *Printers and Print Servers that Support Mirror* on page 1323](#).
- FTP server (with UNIX-style directory listings), configured with the following directories:
 - "`<update-root>/app1`" - This directory is used for printer firmware updates. During an update operation, the printer will first check the "`<update-root>/app1`" directory for new printer firmware
 - "`<update-root>/files`" - This directory is used for printer-resident files. Files in this directory will be stored locally on the printer's file system. Files are not processed by the printer; they are only stored.
 - "`<update-root>/commands`" - This directory is used for a limited number of printer executable commands. The contents of files in this directory will be sent to the printer's command interpreter for execution.
 - "`<feedback-root>`" - This optional directory is used to receive Mirror feedback content from the printer. The content sent to this directory is defined by the "`feedback.get`" template file stored on the printer.
- A client account (user name and password) on the FTP server for the printer to use.
- A Terminal Emulation program, used to send SGD commands to the printer to configure Mirror.

Supported Printers and Print Server Types

These are the Zebra printers, firmware versions, and Zebra print servers that support Mirror.

Table 54 • Printers and Print Servers that Support Mirror

Printer	Firmware	Print Servers
ZT400	V75.19.7Z (or later)	<ul style="list-style-type: none"> • ZebraNet a/b/g/n Print Server • Internal Wireless Plus • Wireless Plus
ZE500	V53.17.15Z (or later)	<ul style="list-style-type: none"> • ZebraNet b/g Print Server • Internal Wireless Plus • Wireless Plus
ZT200	V72.18.2Z (or later)	<ul style="list-style-type: none"> • ZebraNet a/b/g/n Print Server • Internal Wireless Plus • Wireless Plus
105SLPlus	V53.17.15Z (or later)	<ul style="list-style-type: none"> • ZebraNet b/g Print Server • Internal Wireless Plus • Wireless Plus
Xi4™ series	V53.17.5Z (or later)	<ul style="list-style-type: none"> • Internal, Integrated 10/100 IPV4 wired • Internal Wireless Plus
XiIIIPlus™ series	V60.17.5Z (or later)	<ul style="list-style-type: none"> • Internal Wireless Plus • Wireless Plus
105SL™	V60.17.5Z (or later)	<ul style="list-style-type: none"> • Internal Wireless Plus • Wireless Plus
PAX4™	V60.17.5Z (or later)	<ul style="list-style-type: none"> • Internal Wireless Plus • Wireless Plus
ZM400™	V53.17.5Z (or later)	<ul style="list-style-type: none"> • Internal 10/100 wired • Internal Wireless Plus • Wireless Plus
ZM600™	V53.17.5Z (or later)	<ul style="list-style-type: none"> • Internal 10/100 wired • Internal Wireless Plus • Wireless Plus
S4M™	V53.17.5Z (or later)	<ul style="list-style-type: none"> • Internal Wireless Plus • Wireless Plus
G™ -series	V56.17.5Z V61.17.5Z (or later)	<ul style="list-style-type: none"> • Internal 10/100 wired • Internal Wireless Plus • Wireless Plus
LP 2824 Plus TLP 2824 Plus	V61.17.3Z (or later)	<ul style="list-style-type: none"> • Internal 10/100 wired • Internal Wireless Plus • Wireless Plus



Note • Print Servers connected to the parallel port, either externally or internally, are not supported for Mirror use.

How Mirror Works

Mirror utilizes a network connection and FTP communications to perform remote updates and feedback operations. At printer startup and/or at regular intervals, the printer will establish a FTP connection back to a central FTP server and check for updates. During an update operation, the printer will check for updated files in specific directories at the FTP server.

These are the specific FTP server directories that will be checked:

- "`<update-root>/appl`" - This directory is used for printer firmware updates. During an update operation, the printer will first check the "`<update-root>/appl`" directory for new printer firmware
- "`<update-root>/files`" - This directory is used for printer-resident files. Files in this directory will be stored locally on the printer's file system. Files are not processed by the printer; they are only stored.
- "`<update-root>/commands`" - This directory is used for a limited number of printer executable commands. The contents of files in this directory will be sent to the printer's command interpreter for execution.
- "`<feedback-root>`" - This optional directory is used to receive Mirror feedback content from the printer. The content sent to this directory is defined by the "feedback.get" template file stored on the printer.



Note • "`<update-root>`" refers to the value of the "`ip.mirror.path`" configuration parameter.

Files in the `<update-root>/files` directory should not have download headers in them. They should be in the exact format they will be in when stored on the printer's file system. Examples of download headers are: `~DY`, `~DG`, `! CISDFCRC16` or `~DF`.



Important • When the printer is in the Mirror process:

- It is unavailable for other tasks.
- The LCD will indicate that it is performing a Mirror function, showing when the printer is downloading firmware and the names of the object files as they are transferred to the printer.

Mirror Process Summary

The Mirror process follows a specific series of steps:

1. After power-up, the printer will first check the `<update-root>/appl` directory on the FTP server for new printer firmware and update the printer if necessary
2. If the printer did not find new firmware to download, it will then check in the `<update-root>/files` and `<update-root>/commands` directories for updated files - and download them as needed.
3. As a final Mirror step, the printer can perform an optional Feedback operation, transmitting a file of user-defined printer configuration information to `<feedback-root>` directory on the FTP server.
4. Finally, if any files or commands were downloaded during **Step 2:**, the printer will automatically reset itself.

Mirror Process Details

The following items are important to be aware of when configuring the FTP server to support Firmware updated via Mirror.

- Firmware files must be named using the following format:
`<firmware version>.zpl`, where `<firmware version>` is the exact Firmware revision contained in the file. For example, for Firmware version “V53.17.5Z”, the filename stored on the FTP server must be “V53.17.5Z.ZPL”. If the file name and Firmware version do not match, the update will not succeed.
- The firmware filename stored on the FTP server is not case sensitive. This means that “V53.17.5Z.ZPL” and “v53.17.5Z.zpl” will be processed in the exact same way.
- The `/appl` directory can contain only one (1) file at a time. If there is more than 1 file in this directory, the printer will not download anything and will skip the firmware update.

During a Mirror event, the printer will use `<firmware version>` part of the filename contained in the `/appl` directory on the FTP server to check if the Firmware stored on the FTP server is different than the firmware the printer is currently using. If the `<firmware version>` part of the Firmware file name in the `/appl` directory on the FTP server does not exactly match the printer's Firmware version, the file on the FTP server will be downloaded and used to update the printer. Once the printer is updated with the new Firmware, the printer will reset and being using the new Firmware.



Note • Performing the Firmware update first is important because it is possible that the files or commands to be downloaded via Mirror will be dependent on the new firmware.

After the printer has completed the Firmware portion of an update operation, it will check the "`<update-root>/files`" directory and "`<update-root>/commands`" directory (in that order) for updated files that need to be retrieved. If a file exists on the FTP server and the server timestamp for the file does not match the printer's archived timestamp for the file, the printer will re-download the file and update its timestamp info. Files that are on the Mirror FTP server but not currently present on the printer will be sent to the printer. The supported file types are the standard files supported on ZPL printers.

If any files are downloaded during this portion of an update operation, the printer will reboot after the file downloads have completed. At this point, the update operation is complete.



Important •

- Files in the `<update-root>/files` directory should not have download headers in them. They should be in the exact format they will be in when stored on the printer's file system. Examples of download headers are: `~DY`, `~DG`, `! CISDFCRC16` or `~DF`.
- ZPL files in the `<update-root>/files` directory must use the printers internal characters for the Format Command Prefix (^), Delimiter Character (,) and Control Command Character (~). This means that the caret (^) should be replaced with a HEX 1E, the comma (,) should be replaced with a HEX 1F and the tilde (~) should be replaced with a HEX 10.

After an update operation is complete, a printer will perform a feedback operation, if configured to do so. During a feedback operation, the printer will open its feedback template file (named `feedback.get`), populate it based on its contents, and upload the resulting contents file to the FTP server, in the "`<feedback-root>`" directory.



Note • "`<feedback-root>`" refers to the value of the "`ip.mirror.feedback.path`" configuration parameter

Creating ZPL Files for Use in the "<update-root>/files" Directory

When creating ZPL formats that will be stored in the "<update-root>/files" directory it is necessary to edit the files using the following guidelines:

1. Files must contain only one format. This means that if a file contains multiple `^XA` and `^XZ` commands, those sections of the file must be split into separate formats, or combined as one format.
2. The characters used for the Format Command Prefix (^), Delimiter Character (,) and Control Command Characters (~) must be substituted for their Hexadecimal equivalents.
3. The `^XA` and `^XZ` commands must be removed from the formats.
4. The `^DF` command should be removed.

One Format per File

Files must contain only one format. This means that if a file contains multiple `^XA` and `^XZ` commands, those sections of the file must be split into separate formats, or combined as one format. For example, if a ZPL file contains both an initialization string and a format, the two sections must be either split into two files, or combined into one format.

For example, given the following formats:

```
^XA
^LT0^Mnw^MTT^PON^PMN^LH0,0^JMA^PR2,2^LRN^CI0
^XZ
^XA
^F020,100^IME:ZEBRA.BMP^FS
^A@N,75,75,TT0003M_.TTF
^F020,400^FDZebra Technologies^FS
^XZ
```

The following file should be created, which includes all of the command in one file:

```
^XA
^LT0^Mnw^MTT^PON^PMN^LH0,0^JMA^PR2,2^LRN^CI0
^F020,100^IME:ZEBRA.BMP^FS
^A@N,75,75,TT0003M_.TTF
^F020,400^FDZebra Technologies^FS
^XZ
```

Character Substitution

The characters used for the Format Command Prefix (^), Delimiter Character (,) and Control Command Characters (~) must be substituted for their Hexadecimal equivalents. During normal operation, this is how the printer works with ZPL formats. For example, when a ZPL format is sent to the printer via a telnet, RS-232 or Ethernet connection and stored for later use, it automatically processes the file and makes these character substitutions.

When ZPL formats are sent to the printer from the "<update-root>/files" directory they are stored on the printers memory, but not processed. For this reason, it is necessary to preprocess the files so that they are ready for use.

The following character substitutions must be made to files sent from the "<update-root>/files" directory:

Original Character	Substitute Character
Command Prefix The default is the Caret (^)	HEX 1E
Delimiter Prefix The default is the comma (,)	HEX 1F
Control Prefix The default is the tilde (~)	HEX 10

For example, given the following format:

```

^XA
^F020,100^IME:ZEBRA.BMP^FS
^A@N,75,75,TT0003M_.TTF
^F020,400^FDZebra Technologies^FS
^XZ
    
```

It would be necessary to replace the ^ characters with a HEX 1E and the , characters with a HEX 1F. This can be done using a Text Editor. See [Example Files on page 1329](#) for more information.

Removing the ^XA and ^XZ commands

Additionally, the ^XA and ^XZ commands should be removed from the format. The printer will automatically add these commands back in to process the file. See [Example Files on page 1329](#) for more information.

Removing the ^DF command

In some cases, you might have been using files that contain the ^DF command. The purpose of the ^DF command is to instruct the printer to store everything that comes after it in a ZPL file. For example, you might have a file that contains the following:

```
^XA
^DFE:STOREFMT.ZPL^FS
^F025,25^AD,36,20^FN1^FS
^F0165,25^AD,36,20^FN2^FS
^F025,75^AB,22,14^FDBUILT BY^FS
^F025,125^AE,28,15^FN1
^XZ
```

The purpose of the above format - when sent to a printer - would be to store a file called "STOREFMT" to the E memory location on the printer. In production, the goal would be to recall and print the "STOREFMT" file using the following ZPL commands:

```
^XA
^XFE:STOREFMT.ZPL^FS
^FN1^FDZEBRA^FS
^FN2^FDPRINTER^FS
^XZ
```

When this is done using Mirror, the format being sent to the printer must be altered. The line with the ^DF command must be removed - this is because the Mirror process is taking care of storing the format to the E memory location. In this scenario, the original format would be edited to look like this:

```
^F025,25^AD,36,20^FN1^FS
^F0165,25^AD,36,20^FN2^FS
^F025,75^AB,22,14^FDBUILT BY^FS
^F025,125^AE,28,15^FN1
```

The character substitution described above must also be done on the file before it is stored in the "<update-root>/files" directory.

The "recall" format - using the ^XFE:STOREFMT.ZPL command - does not need to be altered or edited. It can be used as it was previously.

Example Files

Example of files that have already been altered in the manner described above are available as "Mirror File Examples" at www.zebra.com.

To see an example file, right-click the paper-clip icon and select Open File or Save Embedded File to Disk 

File Naming Recommendations

- Files in the "<update-root>/files" directory and "<update-root>/commands" directory should not have the same name.
- Files in the "<update-root>/files" should not contain multiple label formats. If you need to Mirror multiple formats, the recommended method is to split the formats into separate files.

Command Use Recommendations

- Files in the "<update-root>/commands" directory should use only SGD commands or the following ZPL commands:
 - ~CC
 - ~CD
 - ~CT
 - ~JA
 - ~JL
 - ~JS
 - ~JX
 - ~RO
- Do not add a device.reset SGD command to the end of a file in the "<update-root>/commands" directory. Mirror will reset itself automatically after performing an update, so there is no need for this command.

Configuration

This section provides detail on the configuring the printer and FTP server for Mirror.

Mirror FTP Server Configuration

For a Zebra printer to successfully use Mirror, the Mirror FTP server must have the following:

- A client account (user name and password) for the printer to use
- A root (base) directory for Mirror updates. This root directory must have the following subdirectories:

```
/appl
/files
/commands
```

- A Mirror feedback folder (optional)



Important • The printer's FTP user account must have the necessary permissions to read/write files in the update and feedback root directories. The `/appl`, `/files`, and `/commands` subdirectories are read only; the Mirror feedback folder is read/write. If these permissions are not properly set, the Mirror update and feedback processes will be unsuccessful.

Mirror Printer Configuration

The following SGD commands are used to configure Mirror on the printer:

<ul style="list-style-type: none"> • <i>ip.mirror.auto</i> on page 1029 • <i>ip.mirror.error_retry</i> on page 1030 • <i>ip.mirror.feedback.auto</i> on page 1031 • <i>ip.mirror.feedback.freq</i> on page 1032 • <i>ip.mirror.feedback.odometer</i> on page 1033 • <i>ip.mirror.feedback.path</i> on page 1034 • <i>ip.mirror.fetch</i> on page 1035 • <i>ip.mirror.freq</i> on page 1036 • <i>ip.mirror.freq_hours</i> on page 1037 	<ul style="list-style-type: none"> • <i>ip.mirror.last_error</i> on page 1038 • <i>ip.mirror.last_time</i> on page 1039 • <i>ip.mirror.password</i> on page 1041 • <i>ip.mirror.path</i> on page 1042 • <i>ip.mirror.reset_delay</i> on page 1043 • <i>ip.mirror.server</i> on page 1044 • <i>ip.mirror.success</i> on page 1045 • <i>ip.mirror.success_time</i> on page 1046 • <i>ip.mirror.username</i> on page 1047 • <i>ip.mirror.version</i> on page 1048
--	--

The Feedback.get File

The Feedback feature is one of the key benefits of the Mirror process. During a Mirror operation, the printer can upload a file to the FTP Server that contains information about the configuration of the printer. This information can then be leveraged by the Administrator to monitor the printer's setup. Using the Feedback feature is optional.

The "`feedback.get`" file is a template file stored on the printer. It controls what content is uploaded to the "`<feedback-root>`" directory on the FTP server. The directory on the FTP server where the printer will send Feedback content to is controlled by the "`ip.mirror.feedback.path`" command.

Within the `feedback.get` file it is possible to leverage SGD commands to insert current printer status and configuration strings into the file. This feature can help make the Feedback file on the FTP server more unique and useful to the Administrator.

Additionally, the first line of the `feedback.get` file is used to control the name of the file that will be uploaded and stored on the FTP server.

For example, if first line of the "`feedback.get`" file was:

```
"zebra.<wlan.mac_raw>.<ip.mirror.feedback.odometer>"
```

That line would be evaluated by the printer and used as the Feedback destination file name to create on the FTP server.

Using the example above, if the MAC address of the wireless print server was "00a0f8ae56d7" and the Feedback odometer was currently at "33", the Feedback file created the FTP server would be named:

```
"zebra.00a0f8ae56d7.33.txt"
```

The "`feedback.get`" file can be sent to the printer using the `!CISDFCRC16` command. For additional information, see [CISDFCRC16 on page 672](#).



Note • The first line of the `feedback.get` file is not included when the Feedback data is written to FTP server.

Example Feedback.get file

Here is an example of a "feedback.get" file and its resulting uploaded file:

```
zebra.<wlan.mac_raw>.<ip.mirror.feedback.odometer>
```

```
Application Name = <appl.name>  
Serial Number = <device.friendly_name>  
  
Mirror Success = <ip.mirror.success>  
Mirror Auto = <ip.mirror.auto>  
Mirror Path = <ip.mirror.path>  
Mirror Last Update = <ip.mirror.success_time>  
  
Bootp Enable = <ip.bootp.enable>  
DHCP Enable = <ip.dhcp.enable>  
Data Port = <ip.port>  
Associated AP = <wlan.bssid>  
RF ESSID = <wlan.essid>  
RF Firmware = <wlan.firmware_version>  
RF Signal Strength = <wlan.signal_strength>  
RF Channel Mask = <wlan.channel_mask>  
  
Label Length = <odometer.total_print_length>  
Print Length = <odometer.label_dot_length>
```

When this file is processed by the printer and uploaded to the FTP server, the resulting upload file on the FTP server would contain data similar to this:

```
Application Name = V53.17.2Z  
Serial Number = ZBR123456  
  
Mirror Success = Yes  
Mirror Auto = on  
Mirror Path = /update-root/ZM400/  
Mirror Last Update = 12345678  
  
Bootp Enable = on  
DHCP Enable = on  
Data Port = 9100  
Associated AP = 124  
RF ESSID = MyEssid  
RF Firmware = 5.2.1  
RF Signal Strength = 98  
RF Channel Mask = FF  
  
Label Length = 100  
Print Length = 200
```

How to Set Up and Use Mirror

This section provides multiple scenarios which include specific examples that demonstrate how to set up and use Mirror.

Scenario One

In this scenario, the printer is configured to perform a Mirror update operation ("ip.mirror.auto = on") and feedback operation ("ip.mirror.feedback.auto = on") every time the printer restarts. On startup, after a network connection has been established, the printer will attempt to make a FTP connection to the server address 10.14.5.133, using the "user name" and "password" of the printer.

If the connection is successful, the printer will attempt to perform an update operation using the root directory "/all_printers/s4m/role1". After the update operation is complete, the printer will attempt a Feedback operation, uploading the resulting Feedback file to the "/all_feedback" directory on the server.

Using the command set in the example below, the printer will not attempt any *periodic* Mirror Update or Feedback operations. It will only perform Mirror operations on startup or when explicitly instructed to using the "ip.mirror.fetch" command.



Note • If a file starts with "/" it signifies the base directory of that file system. If a file is contained in the user's account, they do not start with a "/" .



Example • This example shows a Mirror configuration command set. Each line item of the command set is identified with a number. For details on each line item, see the table below.

```

10 ! U1 SETVAR "ip.mirror.auto" "on"
20 ! U1 SETVAR "ip.mirror.username" "printer"
30 ! U1 SETVAR "ip.mirror.password" "printer"
40 ! U1 SETVAR "ip.mirror.server" "10.14.5.133"
50 ! U1 SETVAR "ip.mirror.path" "/all_printers/s4m/role1"
60 ! U1 SETVAR "ip.mirror.feedback.auto" "on"
70 ! U1 SETVAR "ip.mirror.feedback.path" "/all_feedback"
80 ! U1 SETVAR "ip.mirror.feedback.freq" "0"
    
```

1	Configures the printer to perform a Mirror Update operation at power-up.
2	Configures the FTP Server "user name" for the printer to use
3	Configures the FTP Server "password" for the printer to use
4	Configures the FTP server address the printer should make a FTP connection to.
5	If the FTP connection is successful, the printer should attempt to perform an Update operation using this root directory.
6	Configures a printer to automatically perform a Mirror Feedback operation at start-up.
7	Configures the printer to upload the resulting Feedback file to the designated directory on the server.
8	Configures a printer to repeat the Feedback operation zero times.

Scenario Two

In this scenario, the printer is configured to not perform a Mirror Update function at start-up. It is configured to perform a Mirror Feedback operation at start-up and thereafter at every 60 minutes.

When the 60 minutes elapses, the printer will attempt to make a FTP connection to the server address 10.14.5.133. If the FTP connection is successful, the printer will attempt a Feedback operation, uploading the resulting Feedback file to the "/all_feedback" directory on the server. After the initial Feedback operation, subsequent Feedback operations will occur at an interval of 60 minutes.



Important • Using the command set in the example below, for the printer to attempt any Mirror Update operation unless the "ip.mirror.fetch" command is sent to the printer.



Example • This example shows a Mirror configuration command set. Each line item of the command set is identified with a number. For details on each line item, see the table below.

```

10 ! U1 SETVAR "ip.mirror.auto" "off"
20 ! U1 SETVAR "ip.mirror.username" "printer"
30 ! U1 SETVAR "ip.mirror.password" "printer"
40 ! U1 SETVAR "ip.mirror.server" "10.14.5.133"
50 ! U1 SETVAR "ip.mirror.path" "/all_printers/s4m/role1"
60 ! U1 SETVAR "ip.mirror.feedback.auto" "on"
70 ! U1 SETVAR "ip.mirror.feedback.path" "/all_feedback"
80 ! U1 SETVAR "ip.mirror.feedback.freq" "60"

```

1	Configures the printer to not perform a Mirror Update operation at start-up
2	Configures the FTP Server "user name" for the printer to use
3	Configures the FTP Server "password" for the printer to use
4	Configures the FTP server address the printer should make a FTP connection to.
5	If the FTP connection is successful, the printer should attempt to perform an Update operation using this root directory.
6	Configures a printer to automatically perform a Mirror Feedback operation at start-up.
7	Configures the printer to upload the resulting Feedback file to the designated directory on the server.
8	Configures the printer to attempt a Feedback operation every 60 minutes.

Troubleshooting

If a Mirror process completes unsuccessfully, troubleshooting information can be retrieved by sending this command to the printer:

```
! U1 GETVAR "ip.mirror.last_error"
```

Table 55 lists possible printer responses, an explanation of each, and resolutions. Table 56 provides problem scenarios and solutions.



Important • A mirror path can have up to 50 characters.

Table 55 • Printer Response Troubleshooting

Printer Response	Explanation	Resolution
"connection failed"	The network connection to the Mirror FTP server failed while attempting to perform a printer update.	<ul style="list-style-type: none"> • Check the user name, password, and server address for the Mirror FTP server and ensure that these values are set correctly in the printer. • Ensure that the user name assigned to the printer has the proper permission to log into the Mirror FTP server. • Check that the printer has a successful network connection and is able to send and receive network data.
"Failed to get File: [filename]"	During an update operation, the printer's attempt to retrieve the file [filename] failed.	<ul style="list-style-type: none"> • Ensure that the printer's network connection has not been interrupted. If it has, re-establish network connectivity and retry the update. • Check the server's access permissions for the user name assigned to the printer. Make sure the user name is granted access to read [filename] from the server.
"feedback connection failed"	The network connection to the Mirror FTP server failed while attempting to send printer feedback.	<ul style="list-style-type: none"> • Check the user name, password, and server address for the Mirror FTP server and ensure that these values are set correctly in the printer. • Ensure that the user name assigned to the printer have the proper permission to log into the Mirror FTP server. • Check that the printer has a successful network connection and is able to send and receive network data.

Table 55 • Printer Response Troubleshooting (Continued)

Printer Response	Explanation	Resolution
"Failed getting file to parser : [filename]"	During an update operation, the printer's attempt to retrieve a file [filename] in the <mirror_path>/appl directory failed.	<ul style="list-style-type: none"> • Ensure that the printer's network connection has not been interrupted. If it has, re-establish network connectivity and retry the update. • Check the server's access permissions for the user name assigned to the printer. Make sure the user name is granted access to read [filename] from the server.
"Failed to send feedback file: <feedback_path>/<feedback_filename>"	During a feedback operation, the printer's attempt to store the feedback file in the <feedback_path> directory failed.	<ul style="list-style-type: none"> • Ensure that the printer's network connection has not been interrupted. If it has, re-establish network connectivity and retry the update. • Check the server's access permissions for the user name assigned to the printer. Make sure the user name is granted access to write to the <feedback_path> directory. • Ensure that the <feedback_path> directory exists on the remote server.
"Too many files in the firmware download directory"	The Mirror FTP server has more than one file in the <mirror_path>/appl directory.	Ensure that there is only one (1) firmware file in the <mirror_path>/appl directory.

Table 56 • Problem Scenario Troubleshooting

Problem Scenario	Solution
<p>I performed a Mirror Update and now my printer is continuously reprogramming.</p>	<p>Ensure that the name of the firmware file in <code><mirror_path>/appl</code> matches the version of firmware contained in that file.</p> <p>Example • For firmware version V53.17.2Z, the name of the file in the <code><mirror_path>/appl</code> directory must be <code>V53.17.2Z.ZPL</code> to prevent the continuous reprogramming cycle.</p>
<p>Every time a Mirror Update is run, a file is fetched even though no changes have been made to the files on the server.</p>	<ul style="list-style-type: none"> • Check the names of the files in the <code><mirror_path>/files</code> and <code><mirror_path>/commands</code> directories. If the names are longer than 16 characters (minus extensions), then the printer will truncate them to 16 characters when downloading. If two filenames truncate to the same 16 characters, the printer will not be able to tell the difference between them and will re-download one of the two files during every update operation. • Check the names of the files in the <code><mirror_path>/files</code> and <code><mirror_path>/commands</code> directories. If any of the names are the same, then the printer will not be able to tell the difference. Therefore it will get the one in the files directory, update the timestamp file, and then it will get the one in the commands directory and update the timestamp file. Then, the next time through the one in the files directory will have a different timestamp, so it will get that file again and then check the commands directory, and so on. • Check the server's access permissions for the user name assigned to the printer. Make sure the user name is granted access to read all files in the <code><mirror_path>/files</code> and <code><mirror_path>/commands</code> directories.
<p>The printer is continually rebooting.</p>	<ul style="list-style-type: none"> • Check the <code>/commands</code> directory. If a <code>file.delete</code> command resides, then you need to remove <code>file.delete</code> or modify your script.



Notes • _____

Wireless Markup Language (WML)

Wireless Markup Language (WML) offers a text-based method of designing a menu structure for the display screen of selected printers. By leveraging Set/Get/Do (SGD) and files containing Zebra Programming Language (ZPL) commands, customized menus can be created.

Contents

WML Overview	1340
WML Details	1340
Supported Printers	1341
Professional Services for WML Content Creation	1342
WML Tags	1342
Using WML	1342
WML Examples	1347
Troubleshooting Scenarios	1355

WML Overview

Wireless Markup Language (WML) offers a text-based method of designing customized menus on the LCD front panel of selected printers. By leveraging Set-Get-Do (SGD) and Zebra Programming Language (ZPL) commands, menus that feature both display and command features can be created. The WML “card” structure makes it possible to link from one menu screen to another, creating menus that are as many levels “deep” as desired or reduced to only those options needed by the printer operator.

For details on SGD commands, see [SGD Printer Commands on page 631](#). For details on ZPL commands, see [ZPL Commands on page 47](#).

WML Details

A WML file is made up of tags, which are similar to HTML tags. For a list of the supported WML tags, see [WML Tags on page 1342](#).

Using WML on the printer is dependent on the presence of a single `index.wml` file, stored in the printer's E: memory. The `index.wml` file can contain one or more “cards”, with each card defining the content of a single menu. Everything within the card tag (`<card> </card>`) constitutes one complete front panel menu. Cards can also contain hyperlinks to other menus. If the `index.wml` has three cards, with links between the cards, that means there are three front panel menus. It is also possible to create multiple `.wml` files, with links between them and the `index.wml` file. In cases where multiple `.wml` files are used, it is recommended that each file should be structured to provide a link back to the main menu as described in the `index.wml` card.



Note • Only one `index.wml` file can reside on a printer at any time

WML defined menus can use Set-Get-Do (SGD) commands to retrieve or set printer settings. For example, a menu might display the printer’s current baud rate, while also offering other potential baud rate settings for the printer selection. In more advanced uses, WML defined menus can cause ZPL command files, stored in the printer E: memory, to be injected into the printers command engine – where they will be read in and acted upon. In this use, the ZPL command file files are known as `.nrd` files.

For example, a WML defined menu could call an `.nrd` file that contains a customized set of printer configuration commands. In this way, different profiles can be created for the printer - making it possible for the printer operator to select the appropriate configuration profile needed for the task the printer is being used in.

An important concept to consider is that the WML menu completely defines what is displayed on the printers screen. If an item is not included in the WML menu definition it will not be displayed to the user.



Note • The `index.wml` file must reside on the printer's **E:** drive for the WML menu to display. If the `index.wml` file is on a drive other than **E:**, then the standard front panel menus display.



Note • When a WML menu is resident on the printer, the standard menu system can be easily be accessed by holding down the Cancel and Setup/Exit buttons (on the ZM400) or the Cancel and Setup/Exit buttons (on Xi4) or the Select button (on GX) on the front panel while the printer powers up. Hold the buttons down until the PRINT READY message displays on the front panel. To return to the WML defined menu, reset the printer again.

Supported Printers

WML is supported on the following printers, using the indicated firmware. The buttons on the printers' front panel that are used for Navigating WML defined menus are noted.



Note • When a WML defined menu is in use, the stripes pattern found at the top of selected printers is not displayed.

Table 57 • WML-Supported Printers

Printer	Firmware	Number of "lines" available	Menu Navigation Buttons	Keys to Access Standard Menu System
105SLPlus	V53.17.15 Z (or later)		•	
Xi4™ series	V53.17.5Z (or later)	5	Select + (PLUS) - (MINUS)	Hold down CANCEL & SETUP/EXIT during power-up
ZM400™	V53.17.5Z (or later)	5	Select + (PLUS) - (MINUS)	Hold down CANCEL & SETUP/EXIT during power-up
ZM600™	V53.17.5Z (or later)	5	NEXT/SAVE + (PLUS) - (MINUS)	Hold down CANCEL & SETUP/EXIT during power-up
G™ -series	V56.17.5Z (or later)	4	SELECT SCROLL	Hold down SELECT during power-up

Professional Services for WML Content Creation

Zebra offers a Professional Services group that can help with the creation of WML content. To inquire about Zebra’s Professional Services, please contact your Zebra account representative.

WML Tags

Table 1 shows the WML tags and tag parameters that can be used to create a menu system. As with other tag-based languages, such as HTML and XML, ending tags should be used to indicate the end of a structure. An example of an ending tag would be `</wml>`, which indicates the end of a WML script.

Using WML



Important • Using end tags is required to create well formed and functional WML scripts.

Table 58 • WML Tag Descriptions

<code><wml> </wml></code>	indicates the beginning/end of the WML script
<code><display> </display></code>	indicates the beginning/end of the content to display on-screen
<code><card> </card></code>	indicates the beginning/end of a card
<code><p> </p></code>	indicates the beginning/end of a Paragraph
<code>
</code>	Line break
<code>Menu</code>	Hyperlink to another card
<code><timer value="xx"> </timer></code>	Controls display timer in 10 th of a second increments
<code>" ontimer="#main"</code>	Controls action to take at timer end
<code>alerts="on"</code>	Controls display of on-screen alerts
<code>\$(command.command)</code>	\$ executes a SGD “get”command
<code><do><setvar></do></code>	Controls execution of do and setvar commands

This section provides you with the necessary steps to prepare and transmit WML content to the printer. There are two methods to send WML content to the printer - via the FTP protocol or using the “CISDFCRC16” command. Both methods are detailed below.



Important • The & (ampersand) character should not be used within the body of any Paragraph tag (`<p>`). If an ampersand is present within the body of a Paragraph tag, a WML-based menu may not function as expected.

Create a Sample index.wml File:

1. Open a text editor.
2. Type (or copy/paste) the following text:

```
<wml>
<display>
  <card>
    <p>Hello World!!</p>
  </card>
</display>
</wml>
```

3. Save this file with this name: `index.wml`.

Prepare the Printer to Receive WML Content via FTP:

WML files – and any .nrd files used by a WML menu structure – must be stored in the printers E: memory location. While the files are first being transmitted to the printer, they should not be processed by the printers ZPL formatting engine. This can be done by configuring the SGD settings "ip.ftp.enable" and "ip.ftp.execute_file".

The "ip.ftp.enable" setting allows the printer to receive content via the FTP protocol. The "ip.ftp.execute_file" setting controls the printers' ability to process or not process commands received via the FTP protocol using the printers ZPL engine. By default, both settings are enabled.

1. Set "ip.ftp.enable" to "on" and the "ip.ftp.execute_file" to "off".

To do this, send these commands to the printer:

```
! U1 setvar "ip.ftp.enable" "on"
! U1 setvar "ip.ftp.execute_file" "off"
```

2. To confirm these commands are correctly set, send the getvar command to check the settings. To do this, send these commands to the printer:

```
! U1 getvar "ip.ftp.enable"
! U1 getvar "ip.ftp.execute_file"
```

If a terminal emulation program is being used, the following response should be returned from the printer.

```
"on" "off"
```



Note • Only printers using the Internal 10/100 wired or Internal Wireless Plus & Wireless Plus print server can use the `! U1 setvar "ip.ftp.execute_file" "off"` command. For other print servers, use the "CISDFCRC16" command method detailed below.

Send WML Content to the Printer via FTP

1. Go to a command prompt.
2. At the command line prompt, type "`ftp xxx.xxx.xxx.xxx`", where `xxx.xxx.xxx.xxx` is the IP Address of the printer. For example, if the IP Address of the printer is 10.3.5.34, the command would be:
`ftp 10.3.5.34`
3. Press Enter to connect to the printer.
4. Press Enter to log in to the printer.
5. At the FTP prompt, type "`put index.wml`" and press Enter. The `index.wml` file will be transferred to the printer's E: memory.
6. Type "`quit`" to disconnect from the printer and exit FTP.
7. Power cycle the printer.

Once the printer completes the power cycle the display should look similar to this:



For additional `index.wml` examples, see [WML Examples on page 1347](#).



Note • When a WML menu is resident on the printer, the standard menu system can be easily be accessed by holding down the Cancel and Setup/Exit buttons (on the ZM400) or the Cancel and Setup/Exit buttons (on Xi4) or the Select button (on GX) on the front panel while the printer powers up. Hold the buttons down until the PRINT READY message displays on the front panel. To return to the WML defined menu, reset the printer again.



Important • When using the "`ip.ftp.execute_file`" command, be sure to reset the command back to "on" for use in production processes. If the setting is left in the "off" configuration, when label formats or firmware are sent to the printer via FTP they will not be processed as intended – and the E: memory location can quickly become full.

Resetting the "ip.ftp.execute_file" setting

1. To reset the "ip.ftp.execute_file" setting to the default state, send the following command to the printer.

```
! U1 setvar "ip.ftp.execute_file" "on"
```

Sending WML Content to the Printer via the CISDFCRC16 Command:

WML files – and any .nrd files used by a WML menu structure – must be stored in the printers E: memory location. While the files are first being transmitted to the printer, they should not be processed by the printers ZPL formatting engine. This can be done by using the CISDFCRC16 command. This command allows content to be written directly to the E: memory location, without being processed by the printers ZPL formatting engine. By using the CISDFCRC16 command, WML content can be transmitted to the printer via the Serial, USB or Parallel ports.

For additional information on the CISDFCRC16 command, see [page XX](#).

1. To send the sample index.wml shown earlier, send the following commands to the printer:

```
! CISDFCRC16
0000
INDEX.WML
0000004E
0000
<wml>
<display>
  <card>
    <p>Hello World!!</p>
  </card>
</display>
</wml>
```

2. Power cycle the printer.

Once the printer completes the power cycle the display should look similar to this:

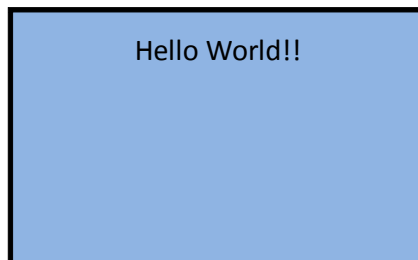

For additional index.wml examples, see [WML Examples on page 1347](#).



Note • When a WML menu is resident on the printer, the standard menu system can be easily be accessed by holding down the Cancel and Setup/Exit buttons (on the ZM400) or Cancel and Setup/Exit buttons (on Xi4) on the front panel while the printer powers up. Hold the buttons down until the PRINT READY message displays on the front panel. To return to the WML defined menu, reset the printer again.

Retrieving WML Content from the Printer using the file.type Command:

It is possible to retrieve .wml file content from the printer using the "file.type" SGD command. To do this, open a terminal emulation connection to the printer and issue the command. For example, to retrieve the contents of the INDEX.WML file, use the following command:

```
! U1 setvar "file.type" "E:INDEX.WML"
```



Note • The file.type command is case sensitive – if the file is stored on the printer as INDEX.WML, the command must use that same case. Additionally, please note that .nrd files are treated as confidential – they cannot be retrieved from the printer.

Using .nrd Files from WML Menus

It is possible to have a WML menu send the contents of a ZPL or SGD file to the printer to be processed. In this way, the WML menu can leverage complex command scripts in response to the user pressing a single button on the printer. One possible use for this capability would be to create a series of “profile” files that contain all the settings necessary to reconfigure the printer for different uses.

The command files are known as “.nrd” files and are stored directly on the printers E: memory location. The .nrd files can be created using a standard text editor and sent to the printer via FTP or using the CISDFCRC16 command. Files should have an “.nrd” extension.

Removing WML or .nrd Files from the Printer using the file.delete Command:

It is possible to remove .wml files from the printer using the file.delete SGD command. To do this, open a terminal emulation connection to the printer and issue the command. For example, to remove the INDEX.WML file, use the following command:

```
! U1 do "file.delete" "E:INDEX.WML"
```

WML Examples

The examples shown below “build” from a simple, display-only, WML menu to a more complex interactive example that uses .nrd files containing ZPL commands. In the initial examples, all lines are explained in detail, in the later examples only the new concepts are covered in detail.

Indenting is used in the examples below to improve readability, it is not necessary in actual use.

Example 1

This example shows a basic WML menu structure that uses only fixed text. The content below shows the WML script plus numbered callouts and a table that identify the function of each of the WML tags.

```
1→ <wml>
2→ <display>
3→   <card>
4→     <p>Hello World!!</p>
5→   </card>
6→ </display>
7→ </wml>
```

1	Beginning of the WML file.
2	Beginning of the content to be displayed.
3	The <code><card></code> tag begins the definition of this menu.
4	The <code><p></code> begins a paragraph, here displaying Hello World! The <code></p></code> ends the paragraph
5	The <code></card></code> tag ends the definition of this menu.
6	End of the content to be displayed.
7	End of the WML file.

In use, this WML menu looks similar to this:

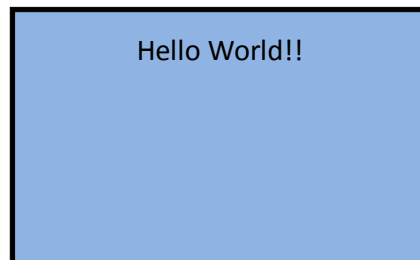

Example 2

This example demonstrates a WML menu structure that uses fixed text, plus two SGD commands to display the current printer settings for the Baud rate and ESSID settings on the printer.

```
1→ <wml>  
2→ <display>  
3→   <card>  
4→     <p>Baud: $(comm.baud)</p>  
5→     <br/>  
6→     <p>AP: $(wlan.essid)</p>  
7→   </card>  
8→ </display>  
9→ </wml>
```

1	Beginning of the WML file.
2	Beginning of the content to be displayed.
3	The <card> tag begins the definition of this menu.
4	The <p> begins a paragraph. 'Baud:' displays the text Baud: \$(comm.baud) retrieves and displays the printers' current baud rate. The </p> ends the paragraph.
5	A line break
6	The <p> begins a paragraph. "AP:" displays the text AP: \$(wlan.essid) retrieves and displays the printers' current ESSID setting. The </p> ends the paragraph.
7	The </card> tag ends the definition of this menu.
8	End of the content to be displayed.
9	End of the WML file

In use, this WML menu looks similar to this:

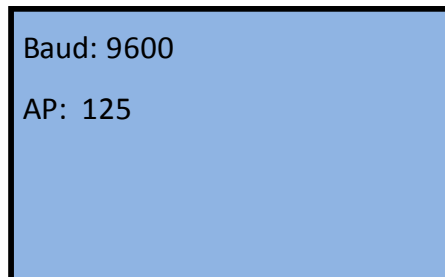

Example 3

This example demonstrates a WML menu structure with two menus. Fixed text and SGD commands are used to display the current printer settings for the Baud rate and ESSID settings on menu one and the Firmware version and ZBI State on menu two. Through use of the ‘timer’ setting, the menu will automatically return to a defined WML card if no buttons are pressed after a set time period. The menu is configured to allow printer alerts (such as HEAD OPEN) to be displayed.

```

1→ <wml>
2→ <display>
3→   <card id="main" title="" ontimer="#main" alerts="on">
4→     <timer value="50"></timer>
5→     <p>Baud: $(comm.baud)</p>
6→     <br/>
7→     <p>AP: $(wlan.essid)</p>
8→     <p> </p><br/>
9→     <p> </p><br/>
10→    <p>   <a href="#system">Firmware</a></p>
11→    </card>
12→    <card id="system" title="" ontimer="#main" alerts="on">
13→      <timer value="50"></timer>
14→      <p>Firmware:</p><br/>
15→      <p>$(appl.name)</p><br/>
16→      <p>ZBI State:</p><br/>
17→      <p>$(zbi.key)</p><br/>
18→      <p>   <a href="#main">Main</a></p>
19→    </card>
20→ </display>
21→ </wml>

```

3	<card id="main" - defines the card's id - "main". title="" - defines the title (not displayed on screen). ontimer="#main" - defines the WML card to display when the timer runs out. alerts="on"> - enables the alerts display feature.
4	<timer value="50"></timer> - sets the timer to 50 (in 10 th of a second increments).
10	<p> Firmware</p> - defines a link to the “system” card.
12	<card id="system" - defines the card's id - "system". title="" - defines the title (not displayed on screen). ontimer="#main" - defines the WML card to display when the timer runs out. alerts="on"> - enables the alerts display feature.
13	<timer value="50"></timer> - sets the timer to 50 (in 10 th of a second increments).
18	<p> Main</p> - defines a link to the “main” card.

In use, these two WML menus look similar to this:

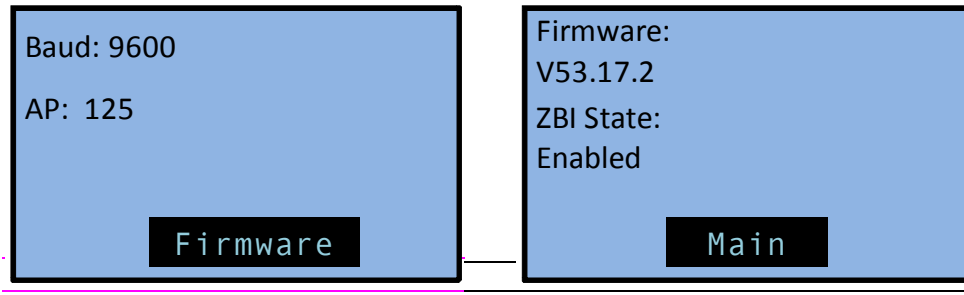

Note • GX series printers can display four lines of text. If you are using a GX series printer, remove one line of text from each “card” to use this example.

Example 4

This example demonstrates a WML menu structure that creates two menu screens and a link to a command file – “config.nrd” – that contains a ZPL command that will cause the unit to print a configuration label.

```

1→ <wml>
2→ <display>
3→   <card id="main" title="" ontimer="#main" alerts="on">
4→     <timer value="50"></timer>
5→     <p>Baud: $(comm.baud)</p>
6→     <br/>
7→     <p>AP: $(wlan.essid)</p>
8→     <p> </p><br/>
9→     <p> </p><br/>
10→    <p>   <a href="#system">Firmware</a></p>
11→    </card>
12→    <card id="system" title="" ontimer="#main" alerts="on">
13→      <timer value="50"></timer>
14→      <p>Firmware:</p><br/>
15→      <p>$(appl.name)</p><br/>
16→      <p>ZBI State:</p><br/>
17→      <p>$(zbi.key)</p><br/>
18→      <p><a href="#main">Main</a>
19→        <a href="#config">Config</a></p>
20→    </card>
21→    <card id="config" title="" ontimer="#main" alerts="on">
22→      <timer value="50"></timer>
23→      <p>Printing </p><br/>
24→      <p> Config Label...</p><br/>
25→      <p></p><br/>
26→      <p>Please wait...</p><br/>
27→      <setvar name="file.run" value="e:config.nrd"/>
28→    </card>
29→  </display>
30→ </wml>

```

18	<pre><p>Main Config</p></pre> <ul style="list-style-type: none"> Defines two links, positioned next to each other - to the "main" and "config" WML cards
26	<pre><setvar name="file.run" value="e:config.nrd"/></pre> <ul style="list-style-type: none"> Defines that the SGD command "file.run" should be used on the "e:config.nrd" file. In this instance, the "e:config.nrd" file contains a single ZPL command - "~wc"

In use, these WML menus look similar to this:

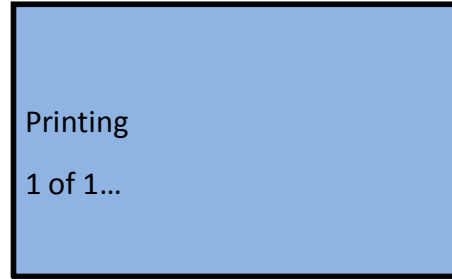
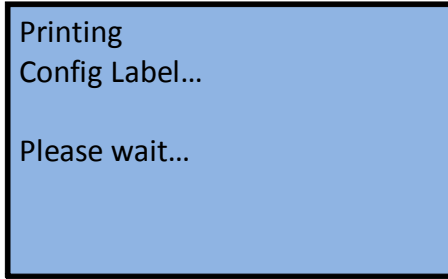
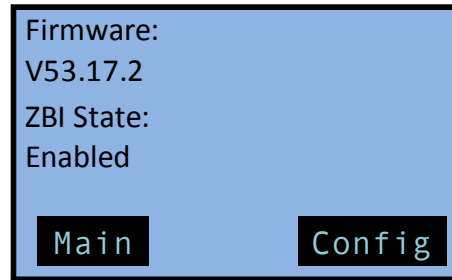
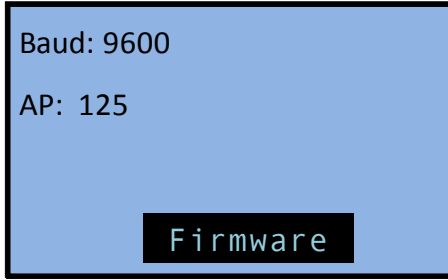

Note • GX series printers can display four lines of text. If you are using a GX series printer, remove one line of text from each “card” to use this example.

Example 5

This example demonstrates a WML menu structure with three cards. The "darkness" card leverages WML and the SGD `print.tone` command to allow the user to both view and configure a setting.

```
1→ <wml>
2→ <display>
3→   <card id="main" title="" ontimer="#main" alerts="on">
4→     <timer value="50"></timer>
5→     <p>Baud: $(comm.baud)</p>
6→     <br/>
7→     <p>AP: $(wlan.essid)</p>
8→     <p> </p><br/>
9→     <p> </p><br/>
10→    <p>   <a href="#system">Firmware</a></p>
11→  </card>
12→  <card id="system" title="" ontimer="#main" alerts="on">
13→    <timer value="50"></timer>
14→    <p>Firmware:</p><br/>
15→    <p>$(appl.name)</p><br/>
16→    <p>ZBI State:</p><br/>
17→    <p>$(zbi.key)</p><br/>
18→    <p><a href="#main">Main</a>           <a href="#darkness">Darkness</a></p>
19→  </card>
20→  <card id="darkness" title="" ontimer="#main" alerts="on">
21→    <timer value="50"></timer>
22→    <p>Current: $(print.tone)</p><br/>
23→    <p>Change: </p><do type="accept" label="Up"><setvar name="print.tone"
24→    value="+1.0"/></do><br/>
25→    <p>Change: </p><do type="accept" label="Down"><setvar
26→    name="print.tone" value="-1.0"/></do><br/>
27→    <p> </p><br/>
28→    <p><a href="#main">Main</a>           <a href="#config">Config</a></p>
29→  <card id="config" title="" ontimer="#main" alerts="on">
30→    <timer value="50"></timer>
31→    <p>Printing </p><br/>
32→    <p> Config Label...</p><br/>
33→    <p></p><br/>
34→    <p>Please wait...</p><br/>
35→    <setvar name="file.run" value="e:config.nrd"/>
36→  </card>
37→ </display>
38→ </wml>
```

23	<pre><p>Change: </p></pre> <ul style="list-style-type: none"> • Defines the fixed text "Change: " • Defines selecting the word "Up" as equal to sending the value "+1.0" for the SGD command "print.tone". In this case, this increases the setting by 1.0.
24	<pre><p>Change: </p></pre> <ul style="list-style-type: none"> • Defines the fixed text "Change: " • Defines selecting the word "Down" as equal to sending the value "-1.0" for the SGD command "print.tone". In this case, this decreases the setting by 1.0.

In use, these WML menus look similar to this:

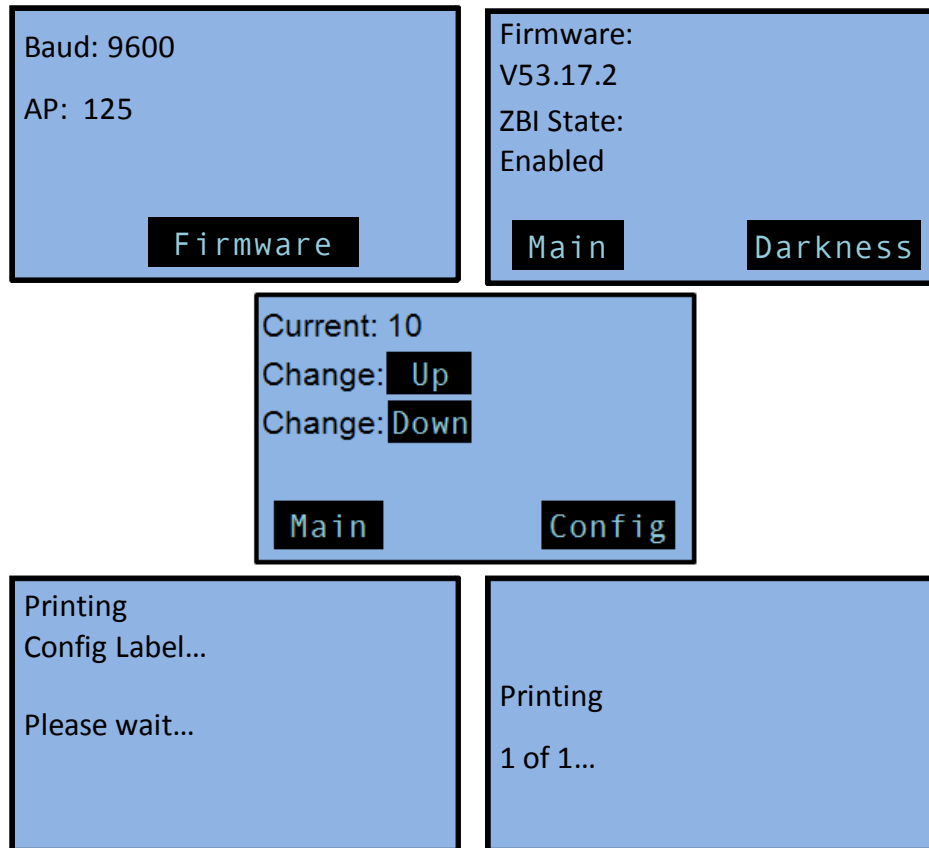

Note • GX series printers can display four lines of text. If you are using a GX series printer, remove one line of text from each “card” to use this example.

Troubleshooting Scenarios

Problem Scenario	Corrective Actions
<p>I loaded a WML menu structure on the printer, but the Factory menu structure is displaying.</p>	<ul style="list-style-type: none"> • "The WML files may have syntax errors. Reconfirm that the correct syntax has been used. When creating WML files it is recommended to start with a simple structure, validate that it's functional and build additional content onto the "known good" example • "Power cycle the printer and watch the start-up sequence - if a "WML ERROR" message displays during the start-up, the index.wml file has a syntax error that needs to be corrected. • "The index.wml file may not have been successfully transferred to the printer. Use a terminal emulation program and the following command to retrieve the index.wml file to the PC for examination: ! U1 setvar "file.type" "E:INDEX.WML" • "The index.wml file may not be present in the E: memory location. Validate that the file is present and correctly named. • "Confirm that straight quotes were used in all instances where the quote character was used (use the " character - not " or ?). SGD commands require the use of the straight quote. • "Confirm that the "WML Menu Cancel" buttons, (Setup and Cancel or Cancel and Setup/Exit or Select) were not held down during start up. These actions will cause the standard menu to display
<p>Some characters in the menu are cut off or some lines are not displaying at all.</p>	<ul style="list-style-type: none"> • Characters that extend past the width of the display are truncated, reposition the field as needed. • Check that you have not exceeded that maximum number of lines the display allows (5 lines on ZM and Xi4 series units, 4 lines on the GX series).
<p>My WML menu structure is displaying, but one of the "cards" is not displaying or is unreachable.</p>	<ul style="list-style-type: none"> • The missing "card" may not have been linked to from any of the visible "cards". Review you WML content to ensure that the correct links exist. • The WML files may have syntax errors, reconfirm that the correct syntax has been used. When creating WML files it is recommended to start with a simple structure, validate that it's functional and build additional content onto a known good example. • If the missing card content is contained in a separate .wml file, confirm that the necessary .wml files have been transferred to the printer.

Problem Scenario	Corrective Actions
<p>My WML menu structure uses SGD commands to display current settings, but the settings are not displaying.</p>	<ul style="list-style-type: none"> • Validate that the correct syntax was used for the SGD command. • Check the manual page for the command being used. Confirm that the command is supported by the printer & firmware. Use a terminal emulation program to send just the command being used to validate it functions outside the WML menu structure. • Confirm that straight quotes were used in all instances where the quote character was used (use the " character – not “ or ”). SGD commands require the use of the straight quote. • Characters that extend past the width of the display are truncated, reposition the field as needed. • Check that you have not exceeded that maximum number of lines the display allows (5 on ZM and Xi4 series units).
<p>My WML menu structure used SGD commands to allow the user to alter printer settings, but the settings are not getting changed as expected.</p>	<ul style="list-style-type: none"> • Validate that the value being used in the <code>value=</code> parameter of the <code><do></code> tag is supported by the SGD command. • Validate that the correct syntax was used for the SGD command. • Check the manual page for the command being used. Confirm that the command is supported by the printer & firmware. Use a terminal emulation program to send just the command being used to validate it functions outside the WML menu structure. • Confirm that straight quotes were used in all instances where the quote character was used (use the " character – not “ or ?). SGD commands require the use of the straight quote.
<p>My WML menu structure uses .nrd files to send commands to the printers ZPL or SGD engine, but the commands don't seem to be getting sent when the user selects the on-screen link for the action.</p>	<ul style="list-style-type: none"> • Confirm that the .nrd files are present in E: memory and named as expected. Resend or rename the files if necessary. • Confirm that the WML menu structure is using the correct file name(s). • Confirm that the commands in the files work as expected, independently of the WML menu or .nrd file. • Validate that ZPL and SGD commands have not been interlaced.
<p>I am using the <code>CISDFCRC16</code> command to transfer files, but the files are either not being transferred to the printer or are showing up with a zero (0) byte size.</p>	<ul style="list-style-type: none"> • Confirm that the Hexadecimal value used for the File Size parameter is correct. This value must be an eight digit file size specified in hexadecimal which indicates the number of bytes in the <code><data></code> section of the command. See the full manual page on the <code>CISDFCRC16</code> command for additional details. • Validate that the CRC and Checksum parameters are correct (using the "0000" value for these parameters is recommended). • Confirm that the WML file name and extension are in upper case characters. • Confirm that the exclamation mark (!) was included before the command name ("<code>! CISDFCRC16</code>").

Using Weblink

What is Weblink and when should it be used?

Weblink is a feature of Zebra Link-OS™ printers. Using a secure connection, the Weblink feature allows the printer to directly connect to an internet based server, for the purpose of either sending information to the server or receiving from the server. Weblink can transport data securely through a firewall.

Weblink can transport any information related to device management, transactional data and information to be processed at a later time. It can be used as part of an overall cost reduction solution that leverages web technologies.

Typically, an application called a ‘servlet’ is created and run on the internet based server, waiting for printers to connect and interact with the servlet. These servlet applications can provide a variety of functions – from sending operating system updates to the printer, to receiving data from the printer and, in turn, using that data to trigger events in other systems.

For example, a solution could be created that would feature the printer consuming data from a Bluetooth® scanner connected to the printer – with that scanned data then being sent from the printer to the internet-based servlet. The servlet would then seek out additional details related to the scanned data, format a document, and then send it to the printer for printing.

Configuring Weblink

When any Weblink setting (with the exception of the logging settings) is adjusted either via SNMP, SGD, or JSON it is required that the printer be reset before the new value takes effect. The `weblink.printer.reset.required` setting will be set to "yes" if there are any settings that have been modified that require a printer reset.

Basic Configuration

To determine how much configuration is necessary the following questions should be considered:

1. Is the remote server the printer is attempting to connect to outside the corporate firewall?
2. Does the firewall require a username and password to access the remote server?
3. Does the printer require a proxy server to access the remote server?
4. Does the firewall permit HTTPS connections initially or does the printer need to connect via HTTP first?

If the answer to any of these questions is 'yes', then more than the basic configuration may be necessary. Depending upon the network environment that the printer is in, accessing the remote server may only require that a few settings be set.

The minimum requirement is that the URL for the remote server be set. For simplicity, assume that only conn1 is being used (this is the typical scenario). See also [Difference Between Conn1 and Conn2 on page 1360](#).

To configure the printer to connect to the remote server:

- a. Set `weblink.ip.conn1.location` to the URL of the remote server.
The URL must conform to the standards described in RFC3986 (<http://www.ietf.org/rfc/rfc3986.txt>). For example, if the remote servlet's full URL is `https://www.examplecorpinc.com/zebra/weblink/`
Configure the location setting as follows:

```
! U1 setvar "weblink.ip.conn1.location"  
"https://www.examplecorpinc.com/zebra/weblink/"
```
- b. Reset the printer.
When the printer has an IP address, it will attempt to connect to the remote server. In the event that the remote server does not indicate that the printer has connected, logging may need to be enabled in order to determine the failure.

When a Proxy Server is Part of the Network Configuration

If a proxy server must be used to access the remote server, the printer's proxy setting must be set to connect to the server. There are typically four properties associated with a proxy server:

- The proxy server scheme: `HTTP` or `HTTPS`
- The proxy server address
- The proxy server port (optional)
- The username and password for the proxy (optional)

To supply the address of the proxy server (assuming a default port and no username/password), configure the proxy setting as follows:

```
! U1 setvar "weblink.ip.conn1.proxy" "https://my.internal.proxy/"
```

In this scenario the proxy address is `my.internal.proxy` and the scheme is `HTTPS`. The default port (1080) will be used. No username or password will be used to authenticate with the proxy.

To specify an alternate port configure the proxy as follows:

```
! U1 setvar "weblink.ip.conn1.proxy"  
"https://my.internal.proxy:3128/"
```

To specify a username and password configure the proxy as follows:

```
! U1 setvar "weblink.ip.conn1.proxy" "https://user:pass@my.internal.proxy/"
```

The proxy username, password, and the rest of the URL must follow the rules specified in RFC3986 (<http://www.ietf.org/rfc/rfc3986.txt>).

When HTTP Authentication is Necessary

Use this configuration when, for example, a firewall requires a username and/or password.

It may be necessary to specify a username and password to various routers and servers along the path to the remote server. Typically when using a browser to access the server the authentication request will be presented in the form of a dialog window that asks for the username and password.

Since the printer's connection to the remote server is headless and non-interactive, the Weblink configuration allows a user to enter in a server name/username/password triplet. The triplet will be used in the event that the printer is presented with an authentication request (for example, this typically is requested via the `HTTP/1.1 401 Unauthorized` request).

To specify authentication credentials, issue the following:

```
! U1 setvar "weblink.ip.conn1.authentication.add" "servername.com username  
password"
```

In this scenario the server requesting authentication is `servername.com`. The username and password to be supplied are 'username' and 'password'. The server name can be either a DNS name or an IP address. The username and password cannot be retrieved from SGD, SNMP, or JSON once added. Only the server name will be returned.

More than one set of authentication triplets can be added. The printer will only use the credentials as they are needed. In other words, the printer will only use the credentials for `servername.com` if it receives a `HTTP/1.1 401 Unauthorized` request from `servername.com`.

To see what authentication triplets are specified issue:

```
! U1 getvar "weblink.ip.conn1.authentication.entries"
```

To remove authentication credentials issue the following:

```
! U1 setvar "weblink.ip.conn1.authentication.remove" "servername.com"
```

Additional Firewall Configuration

Some firewalls do not allow the first connection attempt for a device to be HTTPS or require new connections periodically to keep the initial connections intact. The weblink test branch was provided to address issues that typically arise because the printer is an unattended device.

To configure the printer to attempt an HTTP connection anytime the HTTPS connection drops :

```
! U1 setvar "weblink.ip.conn1.test.location"  
"http://www.zebra.com/apps/linktest"  
! U1 setvar "weblink.ip.conn1.test.test_on" "failure"
```

The `weblink.ip.conn1.test.location` can be any valid HTTP address. The default uses a link provided by Zebra that exists for no other purpose than to help developers test their connections to the internet. Setting `weblink.ip.conn1.test.test_on` to `interval` or `both` will force the printer to attempt a connection to the URL in location every `weblink.ip.conn1.test.retry_interval` seconds (default is 900 seconds/15 minutes).

To configure the printer to try an HTTP connection periodically, independent of the HTTPS success:

```
! U1 setvar "weblink.ip.conn1.test.location"  
"http://www.zebra.com/apps/linktest"  
! U1 setvar "weblink.ip.conn1.test.test_on" "interval"  
! U1 setvar "weblink.ip.conn1.test.retry_interval" "900"
```

Difference Between Conn1 and Conn2

The printer has the ability to connect to two different servers. Connection 1 (`conn1`) and Connection 2 (`conn2`) are identical in every way in terms of their configuration. It is expected that `conn2` will typically be left unmodified unless a user has an alternate server that they wish to use to configure the printer.

A typical scenario in which both connections would be used is if a user wishes to have the printer connect to both a configuration server and a data source.

Enable Logging

If your printer has trouble connecting, you may wish to enable logging. By default logging is not enabled in order to reduce the amount of memory consumed when the Weblink feature is enabled. It is recommended that once the Weblink feature is configured properly and is performing as expected that the logging be disabled or that a very small (less than 100) number of logging entries be permitted.

To enable logging, `weblink.logging.max_entries` needs to be modified. By default it is set to 0, which indicates that no messages are logged. When attempting to troubleshoot connection issues it is recommended that `max_entries` be set to at least 100 entries. Setting `max_entries` to 100 means that the 100 newest logging entries will be present in `weblink.logging.entries` as older entries are discarded once the maximum number of entries is reached.

```
! U1 setvar "weblink.logging.max_entries" "100"
```

The logging settings are atypical to the Weblink settings as they do not require the printer to be reset before taking effect. This does not mean that previous logging message that would have been logged will appear when the `max_entries` setting is changed from 0 to a greater value. It means that any new logging messages will be logged from that point forward.

Issue the following command to clear any log entries currently in the `weblink.logging.entries` buffer.

```
! U1 do "weblink.logging.clear" ""
```

Navigating the Log Output

The log will contain useful information, even in the scenario where the printer successfully connects to the remote server. This section explains how to read the log and highlights some of the key entries that will help to determine if the connection was successful.

A typical log entry looks as follows:

```
[12-04-2012 14:57:10.625] [conn1.1] Attempting connection to  
https://www.examplecorpinc.com/zebra/weblink/
```

The first column is the date and time that the event occurred. The format of the date and time matches the format of `rtc.date` and `rtc.time`. The time, however, also includes the milliseconds to aid in troubleshooting network latency concerns.



Note • For printers that do not have a battery to store the Real Time Clock (RTC) value, the date will be restored to the default value upon a power cycle. The default value depends upon how the `rtc.date` SGD is managed. If it has never been set then it will default to the firmware build date (the value in `appl.date`). Otherwise, the value in `rtc.date` will default to the value that it was last set to. This does not mean the value of the `rtc.date` when it was power cycled. It means that when a user sets `rtc.date` that becomes the new default value. If the printer has a battery then the `rtc.date` is never default and continues to track the date as expected.

The second column indicates the connection name and channel that the entries are associated with. The connection name will match the weblink branch that was configured with the respective URL (for example, `conn1` or `conn2`). The channel number indicates which channel on the respective connection the entries corresponds to.





Note • Channels are additional connections that are requested by the server when the server needs to perform a specific operation that cannot be done on the channel(s) currently open. Typically only the RAW channel is open which operates similar to the RAW TCP port. It is typical to see two channels opened, the main channel and the RAW channel.



The third column is the actual message that contains information about what occurred in the printer at the corresponding time in column one. In the above example the printer was initiating the connection to the URL specified in `weblink.ip.conn1.location`.

Review the section titled [SSL/TLS Certificate Errors on page 1362](#) to understand what it means when certain logging messages/errors appear in the log.

SSL/TLS Certificate Errors

Secure connections to the remote server present the opportunity for several errors when attempting to connect. The errors typically involve the certificates used when connecting via SSL or TLS. This section highlights some of the most common issues involving the certificates.

Error	Cause / Solution
<p>"SSL certificate problem: self signed certificate in certificate chain"</p>	<p>One of the situations that prevent a successful connection is not having the correct Certificate Authority certificates installed on the remote server. Zebra requires that the Zebra Root Certificate Authority and the Zebra Subordinate Certificate Authority be installed on the remote server. This error typically indicates that only one of the Zebra Certificate Authority certificates is installed on the remote server.</p> <p> Important • When using certificate files, the time on the printer must be set correctly for the websocket connection to succeed, as the time is used in the certificate validation.</p>
<p>"SSL certificate problem: unable to get local issuer certificate"</p>	<p>One of the situations that prevent a successful connection is not having the correct Certificate Authority certificates installed on the remote server. Zebra requires that the Zebra Root Certificate Authority and the Zebra Subordinate Certificate Authority be installed on the remote server. This error typically indicates that neither of the Zebra Certificate Authority certificates are installed on the remote server.</p> <p> Important • When using certificate files, the time on the printer must be set correctly for the websocket connection to succeed, as the time is used in the certificate validation.</p>

Error	Cause / Solution
<p>"SSL certificate problem: certificate has expired"</p>	<p>This error indicates that the remote server's certificate has expired. This is typically an indication that the printer's date and/or time are incorrect as the Zebra certificates are typically issued for long durations. Check that <code>rtc.date</code> and <code>rtc.time</code> are set correctly.</p> <p> Note • For printers that do not have a battery to store the Real Time Clock (RTC) value, the date will be restored to the default value upon a power cycle. The default value depends upon how the <code>rtc.date</code> SGD is managed. If it has never been set then it will default to the firmware build date (the value in <code>appl.date</code>). Otherwise, the value in <code>rtc.date</code> will default to the value that it was last set to. This does not mean the value of the <code>rtc.date</code> when it was power cycled. It means that when a user sets <code>rtc.date</code> that becomes the new default value. If the printer has a battery then the <code>rtc.date</code> is never default and continues to track the date as expected.</p> <p> Important • When using certificate files, the time on the printer must be set correctly for the websocket connection to succeed, as the time is used in the certificate validation.</p>
<p>"SSL certificate problem: certificate is not yet valid"</p>	<p>This error indicates that the remote server's certificate was incorrectly issued or that the printer's date and/or time are incorrect. Check that the printer's date and time (<code>rtc.date</code> and <code>rtc.time</code>) are set correctly and that the certificate's start and expiration date are valid.</p> <p> Note • For printers that do not have a battery to store the Real Time Clock (RTC) value, the date will be restored to the default value upon a power cycle. The default value depends upon how the <code>rtc.date</code> SGD is managed. If it has never been set then it will default to the firmware build date (the value in <code>appl.date</code>). Otherwise, the value in <code>rtc.date</code> will default to the value that it was last set to. This does not mean the value of the <code>rtc.date</code> when it was power cycled. It means that when a user sets <code>rtc.date</code> that becomes the new default value. If the printer has a battery then the <code>rtc.date</code> is never default and continues to track the date as expected.</p>

Error	Cause / Solution
<p>"subjectAltName does not match 1.2.3.4"</p> <p>"SSL certificate subject name 'examplecorpinc.com' does not match target host name '1.2.3.4'"</p>	<p>Part of the certificate validation process involves making sure that the remote server is who it claims to be. A certificate can be created to validate against several aliases/DNS names. Typically the certificate will not contain the IP address of the server as IP addresses are subject to change. When specifying the remote server's URL via <code>weblink.ip.conn1.location</code> be sure to specify one of the DNS aliases listed in the certificate. The valid names will be listed either under the Common Name (CN) field and/or the subjectAltName (SAN or Subject Alternate Name) field within the certificate. For example, the certificate may have the CN set to 'examplecorpinc' and the SAN set to 'examplecorpinc.com' or 'alias.for.examplecorpinc.com'. Any of the CN or SAN names can be used, but, as the IP address is not listed in the CN or SAN it cannot. It is not recommended that the IP address be part of the SAN if a DNS name is available to avoid connection issues that may arise due to subnet change or DHCP lease expirations, etc.</p> <p> Important • When using certificate files, the time on the printer must be set correctly for the websocket connection to succeed, as the time is used in the certificate validation.</p>
<p>"Unknown SSL protocol error in connection to ..."</p>	<p>When this message is seen it means that the remote server's SSL/TLS configuration is incorrect. Refer to Troubleshooting on page 1366 to ensure the server and printer are both configured correctly.</p>
<p>I do not see any of these errors, but the printer still does not connect.</p>	<p>Refer to Troubleshooting on page 1366 to ensure the server and printer are both configured correctly.</p>

Other Typical Errors

While SSL/TLS connection errors are the most common, there are issues that can arise that prevent a successful connection. This section highlights the most common issues.

Error	Cause / Solution
<p>"Read failed with an unexpected error"</p>	<p>This message typically indicates that connection to the remote server was lost. The connection can either be lost due to the server powering off or resetting, the firewall or proxy server shutting down the connection, or because the remote server gracefully requests that the connection be discontinued.</p> <p> Note • After 60 seconds of inactivity on the connection the printer will attempt to contact the server via a TCP Keepalive. If the connection is still present the server will respond and the connection will remain open. After 10 successive failed attempts to contact the remote the printer will assume the connection is severed and close the connection. The printer will resume it's attempt to connect to the remote server so that when the server comes back online the printer will re-establish communication.</p>
<p>"Failed to connect (SP = #, CI = #, UW = #, AC = #, PC = #)"</p>	<p>If this error is seen one or more of the '#' values will be set to 0. This is an indication of an incorrect configuration of the remote server. Ensure that the remote server is setup according to the Servlet configuration in the Zebra Link-OS SDK documentation.</p> <p>This typically indicates an incorrect version of the remote Application Server (for example, Apache/Tomcat version may be incorrect). If this issue persists contact Zebra Technical Support.. See Contacts on page 44 and provide the output of the following command (ensure that logging is enabled and that this error appears within the entries).</p> <pre>! U1 getvar "weblink"</pre>

Troubleshooting

Whenever troubleshooting a connection issue, the following questions should be answered to ensure the configuration is correct.

1. Is the printer connected correctly via Wireless or Ethernet?
2. Does the printer have a valid IP address?
3. Can I ping the printer's IP address from a device on the same network as the printer?
4. Is the remote server URL in `weblink.ip.conn1.location` correct and does it point to the remote server that is configured for weblink functionality?
5. Can you connect to the location defined in the `weblink.ip.conn1.location` setting via a browser?
6. Is the remote server I am attempting to connect to outside the corporate firewall?
7. Can the URL specified in `weblink.ip.conn1.test.location` be accessed?
If this is the case, talk with your administrator about altering restrictions for accessing HTTPS connections.
8. Does the firewall require a username and password to access the remote server?
9. Do I require a proxy server to access the remote server?
10. Is the proxy server port the default (1080) or another port (for example, 3128 for the Linux Squid proxy)?



Note • If using the Linux Proxy Server Squid, and you are having trouble connecting, note that it may be configured to:

- a. disallow POST messages
- b. only operate in HTTP/1.0 mode 3
- c. disallow SSL connections.

Refer to your Linux Squid documentation for complete details.

11. Does the firewall permit HTTPS connections initially or do I need to connect via HTTP first?
12. Is the remote server configured to use SSL v3.0 or TLS 1.0?
TLS1.0 is recommended, but SSL v3.0 is also supported. Versions prior to SSL v3.0 and later than TLS v1.0 are not currently supported.
13. Are the Zebra Certificate Authority Certificates correctly installed on the remote server?
14. Was the server's certificate issued by Zebra and is it signed by the Zebra Certificate Authority?
15. Has the server's certificate expired?
16. Is the printer's date and time within the issue and expired period of the server's certificate?

17. Does the value in `weblink.ip.conn1.location` match either the Common Name or one of the names listed in the Subject Alternate Name of the remote server's certificate?
18. Is the proxy server configured correctly and does the respective proxy server allow HTTPS connections via the HTTP CONNECT method?
19. Are there any HTTP authentication attempts when trying to connect that fail?
20. Are there any HTTP/1.1 4xx messages in the log?

If your connection issues persist and the solutions in this document do not help, contact Zebra Tech Support and provide the output of the following command. Ensure that logging is enabled and that the error(s) appear within the entries)

```
! U1 getvar "weblink"
```

HTTP Messages

Message	Cause / Solution
HTTP/1.1 100 Continue	This indicates that the server and printer have begun communicating and is often seen in place of <code>HTTP/1.1 200 OK</code> .
HTTP/1.1 101 Switching Protocols	This indicates that the basic connection to the server worked and the protocol is being switched to a more efficient protocol for data transfer.
HTTP/1.1 200 OK	This indicates that an <code>HTTP GET</code> or <code>HTTP POST</code> was successful.
HTTP/1.1 30x Moved/Redirect/etc	This indicates that the URL specified has moved or that the firewall redirected the printer to another location (typically this is done to authenticate a user in a transparent proxy configuration).
HTTP/1.1 401 Unauthorized	This indicates that the printer either needs to authenticate with the server or failed to authenticate with the remote server (or server/router along the route to the server).
HTTP/1.1 403 Forbidden	This typically means that the authentication was provided and valid, however, the user does not have access to the requested resource.
HTTP/1.1 404 Not Found	This indicates that the remote URL provided points to an invalid location on the server. This does indicate, however, that the server name is valid. Just the path after the domain name is invalid.

HTTP POST Alerts

Link-OS printers can issue alerts to a web server that is listening for HTTP POST requests. The advantage of an HTTP POST alert over the other destinations available (for example, TCP, UDP, SNMP) is that HTTP is firewall friendly.

Configuring Alerts Where the Alert Destination is HTTP POST

Any setting in the `alerts.http` branch that is set will take effect for any `HTTP POST` alerts that occur from that point forward. A printer reset is not required for the settings to take effect.

If the server is configured to accept and process `HTTP POST` messages either via a CGI script or a server-side script such as PHP or ASP then the alert can be forwarded to that server from the printer. The printer will send the alert using the `multipart/form-data` Content-Type. This allows any type of data, including binary data, to be sent via the `POST`.

The `POST` will support two variables within the body of the `POST`:

- `alertMsg` – This is the alert details and the content follows the format of a standard alert when it is issued over one of the other alert destinations (for example, serial, USB, TCP, etc.).
- `uniqueId` – The unique id of the printer. This matches the value in `device.unique_id`.

The `HTTP POST` request will look as follows (sent when the printer was paused)

```
POST /http_post/alert.php HTTP/1.1
Host: 10.3.4.58
Accept: */*
Connection: close
Content-Length: 281
Expect: 100-continue
Content-Type: multipart/form-data; boundary=-----
-----350c75835f46

-----350c75835f46
Content-Disposition: form-data; name="alertMsg"

ALERT%3A%20PRINTER%20PAUSED
-----350c75835f46
Content-Disposition: form-data; name="uniqueId"

XXQLJ120900310
-----350c75835f46--
```



Important • The message is using `HTTP/1.1` and therefore `HTTP/1.1` header fields. This is important because some older proxy servers do not handle these fields gracefully and may block the `POST` message.

It is important to note that the message is using `HTTP/1.1` and therefore `HTTP/1.1` header fields. This is important because some older proxy servers do not handle these fields gracefully and may block the `POST` message.

How to Parse via PHP

The following example shows how to parse the POST message. It does not, however, show how to use this information on other pages, store the results in a database, report this to another device on the domain, etc. The response in this example will be sent back to the printer, but it will be ignored by the printer. If you wish to see the response you can use a packet sniffing tool such as Wireshark.

```
<?php

>alertMsg = urldecode($_POST["alertMsg"]);
if (preg_match("/(\w+(\s+\w+)?):\s+((SGD SET)\s+([\w\d\.\_]+)\s+\s+\s+(\.+)|([\w\s]+))/", $alertMsg, $matches)== 1) {

>alertType = $matches[1];

if ($matches[5] === "SGD SET") {
>alertCondition = $matches[5];
>alertSgdName = htmlspecialchars($matches[6]);
>alertSgdData = htmlspecialchars($matches[7]);
} else {
>alertCondition = $matches[3];
}
}

echo "<H1>Alert Received</H1><br/>\r\n";
echo "<h2>Original Message = $alertMsg</h2><br/>\r\n";
echo "<h2>Alert Type = $alertType</h2><br/>\r\n";
echo "<h2>Alert Condition = $alertCondition</h2><br/>\r\n";
echo "<h2>SGD Name = $alertSgdName</h2><br/>\r\n";
echo"<h2>SGD Value = $alertSgdData</h2><br/>\r\n";
?>
```

Basic Configuration

To determine how much configuration is necessary, consider the following questions:

- Is the remote server that the printer is attempting to connect to outside of the corporate firewall?
- Does the firewall require a username and password to access the remote server?
- Does the printer require a proxy server to access the remote server?

If the answer to any of these questions is 'yes', then more than the basic configuration may be necessary. Depending upon the network environment that the printer is in access the remote server may only require that a few settings be set.

To configure an alert to be sent via HTTP POST to a remote server , issue the following command:

```
! U1 setvar "alerts.add" "PRINTER PAUSED,HTTP-  
POST,Y,Y,http://www.examplecorpinc.com/alerts.php,0,N, "
```

The above command will issue an HTTP POST alert to the remote server (<http://www.examplecorpinc.com/alerts.php>) when the printer is paused or un-paused.

- The first parameter indicates the condition to monitor. A list of available alert conditions can be viewed by issuing:

```
! U1 getvar "alerts.conditions"
```
- The second parameter indicates the alert destination. For the purposes of this section HTTP-POST is the preferred destination. A list of available alert destinations can be viewed by issuing:

```
! U1 getvar "alerts.destinations"
```
- The third and fourth parameters are 'Send on Set' and 'Send on Clear', respectively. They can be either "Y" for monitor the alert or "N" for don't monitor the alert. If both are set to "N" then the alert will not be added or it will be deleted if the alert already existed. To view which alerts already exist issue:

```
! U1 getvar "alerts.configured"
```
- The fifth parameter holds the URL for the server that will be sent the HTTP POST. It holds a maximum of 255 characters for the URL and it must conform to the URI standards described in RFC3986 (<http://www.ietf.org/rfc/rfc3986.txt>).
- The sixth parameter should be set to 0 for HTTP POST alerts.
- The seventh parameter and eighth parameter will not be covered in this section and should be set as indicated in the description above. See the SGD documentation for details on these two parameters.

When a Proxy Server is Part of the Network Configuration

If a proxy server must be used to access the remote server the printer's proxy setting must be set to point to the server. There are typically four properties associated with a proxy server.

- The proxy server scheme: **HTTP** is the only supported scheme
- The proxy server address

- The proxy server port (optional)
- The username and password for the proxy (optional)

To supply the address of the proxy server, assuming a default port and no username/password, configure the proxy setting as follows:

```
! U1 setvar "alerts.http.proxy" "http://my.internal.proxy/"
```

In this scenario, the proxy address is `my.internal.proxy` and the scheme is `HTTP`. The default port (1080) will be used. No username or password will be used to authenticate with the proxy.

To specify an alternate port, configure the proxy as follows

```
! U1 setvar "alerts.http.proxy" "http://my.internal.proxy:3128/"
```

To specify a username and password, configure the proxy as follows:

```
! U1 setvar "alerts.http.proxy" "http://user:pass@my.internal.proxy/"
```

The proxy username, password, and the rest of the URL must follow the rules specified in RFC3986 (<http://www.ietf.org/rfc/rfc3986.txt>).

When HTTP Authentication is Necessary

Use this configuration when, for example, a firewall requires a username and/or password.

It may be necessary to specify a username and password to various routers and servers along the path to the remote server. Typically when using a browser to access the server the authentication request will be presented in the form of a dialog window that asks for the username and password.

Because the printer's connection to the remote server is headless and non-interactive, the alert http configuration allows a user to enter in a server name, username, password triplet. The triplet will be used in the event that the printer is presented with an authentication request (for example, this typically is requested via the HTTP/1.1 401 Unauthorized request).

To specify authentication credentials issue the following:

```
! U1 setvar "alerts.http.authentication.add" "servername.com username password"
```

In this scenario the server requesting authentication is `servername.com`. The username and password to be supplied are 'username' and 'password'. The server name can be either a DNS name or an IP address. The username and password cannot be retrieved from SGD, SNMP, or JSON once added. Only the server name will be returned.

More than one set of authentication triplets can be added. The printer will only use the credentials as they are needed. In other words, the printer will only use the credentials for `servername.com` if it receives a HTTP/1.1 401 Unauthorized request from `servername.com`.

To see what authentication triplets are specified issue:

```
! U1 getvar "alerts.http.authentication.entries"
```

To remove authentication credentials issue the following:

```
! U1 setvar "alerts.http.authentication.remove" "servername.com"
```

Enabling Logging

If your printer has trouble connecting, you may wish to enable logging. By default, logging is not enabled in order to reduce the amount of memory consumed when the HTTP alert feature is enabled. It is recommended that once the alert HTTP feature is configured properly and is performing as expected that the logging be disabled or that a very small (less than 100) number of logging entries be permitted.

To enable logging, `alerts.http.logging.max_entries` needs to be modified. By default it is set to 0, which indicates that no messages are logged. When attempting to troubleshoot connection issues it is recommended that `max_entries` be set to at least 100 entries. Setting `max_entries` to 100 means that the 100 newest logging entries will be present in `alerts.http.logging.entries` as older entries are discarded once the maximum number of entries is reached.

```
! U1 setvar "alerts.http.logging.max_entries" "100"
```

The logging settings do not require the printer to be reset before taking effect. This does not mean that previous logging message that would have been logged will appear when the `max_entries` setting is changed from 0 to a greater value. It means that any new logging messages will be logged from that point forward.

Issue the following command to clear any log entries currently in the `alerts.http.logging.entries` buffer.

```
! U1 do "alerts.http.logging.clear" ""
```

Navigating the Log Output

The log can contain much information, even in the scenario where the printer successfully connects to the remote server. This section explains how to read the log and highlights some of the key entries that will help to determine if the connection was successful.

A typical log entry looks as follows:

```
[12-04-2012 14:57:10.625] [http] Attempting connection to  
http://www.examplecorpinc.com/alerts.php
```

The first column is the date and time that the event occurred. The format of the date and time matches the format of `rtc.date` and `rtc.time`. The time, however, also includes the milliseconds to aid in troubleshooting network latency concerns.

The second column indicates the connection name, which is currently always set to 'http'.

The third column is the actual message that contains information about what occurred in the printer at the corresponding time in column one. In the above example the printer was attempting to POST the alert to the connection to the URL specified in the configured alert.

Review [Understanding Errors in the Alerts HTTP Log on page 1376](#) to understand what it means when certain logging messages/errors appear in the log.

Understanding Errors in the Alerts HTTP Log

Error	Cause / Solution
Couldn't connect to host	<p>This could mean any number of things occurred that prevented the printer from connecting. This message is always present when the connection to the remote failed and is typically accompanied by an HTTP Response Code. See HTTP Messages on page 1378 for the possible HTTP Response Codes and their meaning.</p> <p>If this issue persists contact Zebra Technical Support.. See Contacts on page 44 and provide the output of the following command (ensure that logging is enabled and that this error appears within the entries).</p> <pre>! U1 getvar "alerts"</pre>

Troubleshooting

Whenever troubleshooting a connection issue, the following questions should be answered to ensure the configuration is correct.

1. Is the printer connected correctly via Wireless or Ethernet?
2. Does the printer have a valid IP address?
3. Can I ping the printer's IP address from a device on the same network as the printer?
4. Is the remote server URL listed in the output of the `alerts.configured` SGD or `~HU` command output correct, and is the URL of a server iserver that is configured to accept HTTP POST requests?
5. Can you connect to the URL via a browser?
6. Is the remote server I am attempting to connect to outside the corporate firewall?
7. Does the firewall require a username and password to access the remote server?
8. Does the printer require a proxy server to access the remote server?
9. Is the proxy server port the default (1080) or another portt?
10. Is the proxy server configured to allow HTTP POST messages?
11. Is the proxy server HTTP 1.1 compliant and does it allow HTTP 100 Continue messages?
For example, the Squid Proxy Server versions before v3.2 do not fully support HTTP 1.1 requests and may block any HTTP POST attempts from the printer.



Note • If using the Linux Proxy Server Squid, and you are having trouble connecting, note that it may be configured to:

- a. disallow POST messages
- b. only operate in HTTP/1.0 mode 3
- c. disallow SSL connections.

Refer to your Linux Squid documentation for complete details.

12. Are there any HTTP authentication attempts when trying to connect that fail?

Are there any HTTP/1.1 4xx messages in the log?

If your connection issues persist and the solutions in this document do not help, contact Zebra Technical Support.. See [Contacts on page 44](#) and provide the output of the following command (ensure that logging is enabled and that this error appears within the entries).

```
! U1 getvar "alerts"
```

HTTP Messages

Message	Cause / Solution
HTTP/1.1 100 Continue	This indicates that the server and printer have begun communicating and is often seen in place of HTTP/1.1 200 OK .
HTTP/1.1 200 OK	This indicates that the HTTP POST was successful.
HTTP/1.1 30x Moved/Redirect/etc	This indicates that the URL specified has moved or that the firewall redirected the printer to another location (typically this is done to authenticate a user in a transparent proxy configuration).
HTTP/1.1 401 Unauthorized	This indicates that the printer either needs to authenticate with the server or failed to authenticate with the remote server (or server/router along the route to the server).
HTTP/1.1 403 Forbidden	This typically means that the authentication was provided and valid, however, the user does not have access to the requested resource.
HTTP/1.1 404 Not Found	This indicates that the remote URL provided points to an invalid location on the server. This does indicate, however, that the server name is valid. Just the path after the domain name is invalid.

Glossary

ASCII American Standard Code for Information Interchange. A 7-bit character set that includes Latin characters, as well as control and punctuation characters.

bidirectional text layout The arrangement of characters with mixed directionality on a single line. For example, English and Arabic.

big-endian In the encoding, the most significant byte is stored first.

byte order mark BOM; indicates big-endian (BE) or little-endian (LE).

character The smallest component of a writing system that has understanding, refers to the abstract meaning not the specific shape.

character code Another term for code point.

character set A collection of characters.

character shaping Characters assume different glyphic forms depending on the context. They can be used with a script-based language.

code point An integral reference number assigned to a character.

coded character set An ordered collection of characters that are assigned an integral reference number.

combining semantic cluster Consists of an atomic character, a combining character sequence consisting of a base character plus one or more nonspacing marks, enclosing marks, combining word joiner, such as an Indic virama, or a sequence of Hangul jamos equivalent to a Hangul syllable.

diacritic A mark that is added to a letter or other character to change its value or meaning.

encoding The mapping of a characters code points to a sequence of bytes used to represent the data.

font An electronic collection of glyphs used for the visual representation of characters.

GB18030 A standard required by the People's Republic of China for operating systems of non-handheld computers.

GB 2312 A Chinese character set and encoding.

glyph The visual representation of a character, such as a shape or image. A default glyph character is typically used when the requested glyph is not available in the font.

grapheme cluster Consists of an atomic character, a combining character sequence consisting of a base character plus one or more nonspacing marks or enclosing marks, or a sequence of Hangul jamos equivalent to a Hangul syllable.

ISO 10646 An international standard that defines the Universal Character Set (UCS) and a character encoding. The UCS matches Unicode.

ISO 8859-1 An encoding standard for representing Western European languages using the Latin Alphabet.

language A system of sounds and scripts used to represent and communicate concepts, ideas, meanings, and thoughts.

ligature A glyph representing a combination of two or more characters.

little-endian In the encoding, the least significant byte is stored first.

open type A file format for scalable font files that extends the existing TrueType font file format used by Microsoft Windows and Apple Macintosh operating systems. OpenType tables support advanced layout features.

presentation form A pre-combined character, ligature or variant glyph that has a separate code point; used for compatibility.

script A collection of symbols used to represent textual information in one or more writing systems.

Shift-JIS A shifted encoding of the Japanese character encoding standard, JIS X 0208, heavily deployed in PCs.

True type An outline font format that is scalable without quality loss.

Unicode The universal character set and encoding maintained by the Unicode Consortium.

UTF-8 The Unicode encoding that assigns each character code point to a sequence of one to four bytes.

UTF-16 A Unicode encoding form that represents Unicode code point values in the BMP with 16-bit code units and Unicode code point values in the supplementary planes with pairs of 16-bit code units.

UTF-16BE A Unicode encoding scheme based on UTF-16 that serializes the bytes in each code unit in big-endian order.

UTF-16LE A Unicode encoding scheme based on UTF-16 that serializes the bytes in each code unit in little-endian order.

Index

Symbols

^KC, set client identifier (CID), 434
^MW, 311
^NB, network boot, 435
^NN, set SNMP parameters, 436
^NP, set primary/secondary device, 437
^NT, set SMTP, 438
^NW, set web authentication timeout value, 439
^WA, set antenna parameters, 440
^WE, set wireless encryption values, 441
^WI, change wireless network settings, 443
^WL, set LEAP parameters, 445
^WP, set wireless password, 447
^WR, set transmit rate, 448
^WS, set wireless radio card values, 450
! (EXCLAMATION MARK) ZBI command, 471
~WR, reset wireless radio card and print server, 449

A

abort download graphic, 176
absolute mode for RFID, 413
ACCEPT ZBI command, 518
access password
 set via ^RQ, 407
 set via ^RZ, 427
access point
 associated, 1103
 MAC address, 1105, 1164
ADDBREAK ZBI command, 485
adhoc auto mode, 1101
adhoc channel, 1102
advanced counter reset, 335
AFI byte
 read command (^RA), 394
 write command (^WF), 429

alphanumeric default font
 change, 152
antenna parameter setting via ZPL, 440
antenna port
 select using ZPL, 425, 426
appl.bootblock, 662
appl.date, 663
appl.name, 664
applicator functions (ZBI)
 AUXPORT_GETPIN, 567
 AUXPORT_RELEASEPIN, 568
 AUXPORT_SETPIN, 566
 AUXPORT_STEALPIN, 565
 description, 564
applicator reprint, 330
ARP
 setting using external_wired.ip.arp_interval, 917
 setting using internal_wired.ip.arp_interval, 937
ARP interval or cache time out, 917, 937, 990, 1116
array functions
 description, 594
array functions (ZBI)
 COLUMNSIZE, 599
 DELROW, 597
 FIND, 600
 INSERTROW, 596
 REDIM, 595
 ROWSIZE, 598
authentication
 timeout for printer home page, 439
AUTONUM ZBI command, 473
auxiliary port
 set, 261, 264
AUXPORT_GETPIN ZBI command, 567
AUXPORT_RELEASEPIN ZBI command, 568
AUXPORT_SETPIN ZBI command, 566

AUXPORT_STEALPIN ZBI command, 565

B

backfeed sequence

change, 273, 274, 342

bar code field default, 147

base types & expressions (ZBI)

LET, 494

base types and expressions

variable names, 490

base types and expressions (ZBI), 489

arrays, 491

assignment, 493

boolean expressions, 499

combined boolean expressions, 501

constants, 491

numeric expressions, 495

string concatenation, 497

sub-strings, 497

variable declarations, 491

variable names, 491

battery

set condition, 256

battery status, 217

bitmap font

download, 168

bitmapped fonts, 1210

bluetooth.address, 640, 643, 644, 645, 647, 648,
649, 650, 651, 652, 654, 655, 656, 657, 658,
660, 665, 666, 667, 668, 669, 670, 744, 746,
958, 970, 1057, 1075, 1077, 1139

bluetooth.afh_map, 971

bluetooth.afh_map_curr, 972

bluetooth.afh_mode, 973

bluetooth.authentication, 974

bluetooth.bluetooth_pin, 975

bluetooth.date, 976

bluetooth.discoverable, 977

bluetooth.enable, 978

bluetooth.friendly_name, 979

bluetooth.local_name, 980

bluetooth.radio_auto_baud, 982

bluetooth.radio_version, 983

bluetooth.short_address, 984

bluetooth.version, 985

bootp

enable or disable, 991

box, 209

BREAK ZBI command, 484

C

cache on, 160

calibration

using SGD, 854

using ZPL (^HR), 387

calibration, setting dynamic media, 376

cancel all, 250

cancel format, 270

card.inserted, 987

card.mac_addr, 986, 1153

caret

change, 148

change alphanumeric default font, 152

change backfeed sequence, 273, 274, 342

change caret, 148

change delimiter, 151

change international font, 153

change memory letter designation, 157

change tilde, 163

channel mask

setting via ^WS, 450

chip serialization, 420

CHR\$ ZBI command, 571

circle, 211

Cisco LEAP, 1150

CISDFCRC16

download files, 672

client identifier, 923, 944, 1000, 1123

client identifier (CID), 434

CLIENTSOCKET ZBI command, 517

CLOSE ZBI command, 513

CLRERR ZBI command, 562

CODABLOCK, 89

considerations for ^FD character set, 92

considerations for the ^BY, 91

code 11, 64

code 128

subsets, 95

subsets A and C, 98

subsets a, b, and c, 93

code 39, 68

code 49, 72

automatic mode, 75

field data character set, 75

code 93, 85

full ASCII mode, 87

code validation, 164

COLUMNSIZE ZBI command, 599

comm.baud, 674

comm.halt, 675

comm.parity, 678

comm.pnp_option, 676

comm.stop_bits, 679

comm.type, 677

comma separated values (CSV) ZBI commands

CSVLOAD, 541

CSVSTORE, 543

- description, 540
- TXTLOAD, 544
- TXTSTORE, 545
- command structure, 635, 914, 969
- Command/Function NAME, 462
- comment, 208
- communications diagnostics, 254
 - enable, 254
- concatination, 203
- configuration
 - update, 277
- configuration
 - using ZPL commands, 433, 1193, 1243
- configuration label
 - print, 363
- contacts, 44
- control and flow commands (ZBI)
 - description, 502
 - DO loops, 504
 - END, 509
 - EXIT, 508
 - FOR loops, 505
 - GOTO/GOSUB, 506
 - IF statements, 503
 - SUB, 507
- counter reset
 - by ZPL (~RO), 335
 - SGD for RFID valid label counter, 832
 - SGD for RFID void label counter, 833
- country code, 840
- CSVLOAD ZBI command, 541, 545
- CSVSTORE ZBI command, 543
- CTRL-C ZBI command, 479
- current partially input format
 - cancel, 279
- currently connected printer
 - set transparent, 320
- customer service, 44
- cutter.clean_cutter, 680

D

- darkness
 - set, 337
- data log for RFID, 385
- data matrix, 143
- DATAREADY ZBI command, 514
- date for real time clock
 - set, 355
- DATE ZBI command, 605
- DATE\$ ZBI command, 603
- DEBUG ZBI command, 482
- define EPC data structure (^RB), 395
- define kiosk values, 286
- define language, 283

- define password, 285
- define printer name, 284
- DELBREAK ZBI command, 486
- delete object, 244
- delimiter
 - change, 151
- DELROW ZBI command, 597
- description information
 - display, 242
- detect multiple RFID tags (^RN), 406
- device.command_override, 693
- device.download_connection_timeout, 699
- device.epi_legacy_mode, 700
- device.friendly_name, 702
- device.frontpanel.feedenabled, 703
- device.frontpanel.key_press, 704
- device.frontpanel.line1, 705
- device.frontpanel.line2, 706
- device.frontpanel.xml, 707
- device.host_identification, 708
- device.host_status, 709
- device.jobs_print, 714
- device.languages, 713, 715
- device.orientation, 719
- device.pnp_option, 721
- device.reset, 727
- device.restore_defaults, 728
- device.unique_id, 739
- device.uptime, 741
- device.user_p1, 742
- device.user_p2, 743
- device.xml.enable, 747
- DHCP
 - CID prefix, 921, 942
 - enable, 920, 941
- diagnostics
 - disable, 255
- diagonal line, 212
- directory label
 - print, 364
- disable diagnostics, 255
- discharge mode
 - battery, 281
- display description information, 242
- display results of certain commands
 - rfid.tag.read.result_line1, 858
 - rfid.tag.read.result_line1_alternate, 860
 - rfid.tag.read.result_line2, 859
 - rfid.tag.read.result_line2_alternate, 861
 - rfid.tag.test.result_line1, 865
 - rfid.tag.test.result_line2, 866
- display RFID tag data
 - SGD, 855
- display.text, 751, 752

- do
 - device.restore_defaults, 728
 - file.dir, 765, 766, 771
 - media.cut_now, 791
 - media.present.eject, 797
- do command, 634, 913, 968
- DO loops ZBI command, 504
- double signal mode
 - setting, 414
- download bitmap font, 168
- download encoding, 170
- download files, 672
- download format, 172
- download graphic
 - abort, 176
- download graphics, 173, 180
- download Intellifont, 177
- download true type font, 178
- download unbounded true type font, 179
- dynamic media calibration, setting, 376

E

- E.A.S. bit enable/disable command (^RE), 397
- EAN-13, 108
- EAN-8, 81
- ECHO ZBI command, 475
- editing commands (ZBI)
 - ! (EXCLAMATION MARK), 471
 - AUTONUM ZBI command, 473
 - description, 468
 - ECHO ZBI command, 475
 - LIST ZBI command, 472
 - NEW, 469
 - REM, 470
 - RENUM ZBI command, 474
- Electronic Product Code (EPC)
 - define EPC data structure (^RB), 395
 - write EPC data via ^RQ, 407
 - write EPC data via ^RZ, 427
- ellipse, 213
- enable RFID motion (^RM), 405
- encoding
 - download, 170
 - select, 338
- encoding results, 422
- encryption
 - set LEAP parameters, 445
 - set values via ZPL, 441
- encryption key, 1111
- end format, 377
- END ZBI command, 509
- erase download graphics, 184
- ESSID
 - printer, 1113

- setting via ^WS, 450
- events (ZBI)
 - available events, 547
 - description, 546
 - HANDLEEVENT, 554
 - REGISTEREVENT, 551
 - TRIGGEREVENT, 556
 - UNREGISTEREVENT, 553
 - ZBI Key Names, 549
- EXIT ZBI command, 508
- external wired gateway address
 - change, 924
- external wired subnet mask address
 - enable or disable, 925
- external_wired.check, 915
- external_wired.ip.addr, 916
- external_wired.ip.arp_interval, 917
- external_wired.ip.default_addr.enable, 918
- external_wired.ip.dhcp.cid_all, 919, 940
- external_wired.ip.dhcp.cid_enable, 920
- external_wired.ip.dhcp.cid_prefix, 921
- external_wired.ip.dhcp.cid_suffix, 922
- external_wired.ip.dhcp.cid_type, 923
- external_wired.ip.gateway, 924
- external_wired.ip.netmask, 925
- external_wired.ip.port, 926
- external_wired.ip.timeout value, 929, 961
- external_wired.ip.timeout.value, 929, 961
- external_wired.ip.v6.addr, 930
- external_wired.ip.v6.gateway, 931
- external_wired.ip.v6.prefix_length, 932
- external_wired.mac_addr, 933
- external_wired.mac_raw, 934
- EXTRACT\$ ZBI command, 580

F

- feedback
 - suppress, 373
- field
 - field reverse, 201
 - orientation, 206
 - parameter, 200
 - separator, 202
 - typeset, 203
 - variable, 205
- field block, 184, 185
- field data, 189
- field hexadecimal indicator, 190
- field number, 198
- field orientation, 206
- field origin, 199
- field parameter, 200
- field reverse print, 201
- field separator, 202

- field typeset, 203
 - field variable, 205
 - file system commands (ZBI)
 - DELETE ZBI command, 539
 - descripiton, 533
 - DIR ZBI command, 538
 - LOAD ZBI command, 537
 - STORE ZBI command, 536
 - file.delete, 764
 - file.dir, 765, 766, 771
 - file.run, 768
 - file.type, 767
 - files
 - download, 672
 - FIND ZBI command, 600
 - firmware
 - supported RFID tag types for each version, 415, 867
 - ZPL command compatibility, 380
 - firmware version of RFID reader, 850
 - flash memory
 - initialize, 251
 - font identifier, 166
 - font linking, 192
 - font name
 - to call font, 60
 - fonts
 - font matrices, 1215
 - standard printer fonts, 1210
 - FOR loops
 - ZBI command, 505
 - format
 - cancel, 270
 - download, 172
 - end, 377
 - pause, 270
 - recall, 374
 - set, 372
 - FTP protocol setting, 1015
 - function rules, 463
- G**
- gateway address
 - change, 1018
 - Gen 2
 - printers and firmware that support Gen 2, 415, 868
 - setting password or locking tag, 427
 - write EPC data to tag via ^RQ, 407
 - write EPC data to tag via ^RZ, 427
 - getvar
 - appl.bootblock, 662
 - appl.date, 663
 - appl.name, 664
 - arp_interval, 990
 - bluetooth.address, 640, 643, 644, 645, 647, 648, 649, 650, 651, 652, 654, 655, 656, 657, 658, 660, 665, 666, 667, 668, 669, 670, 744, 746, 958, 970, 1057, 1075, 1077, 1139
 - bluetooth.afh_map, 971
 - bluetooth.afh_map_curr, 972
 - bluetooth.afh_mode, 973
 - bluetooth.authentication, 974
 - bluetooth.bluetooth_pin, 975
 - bluetooth.date, 976
 - bluetooth.discoverable, 977
 - bluetooth.enable, 978
 - bluetooth.friendly_name, 979
 - bluetooth.local_name, 980
 - bluetooth.radio_auto_baud, 982
 - bluetooth.radio_version, 983
 - bluetooth.short_address, 984
 - bluetooth.version, 985
 - card.inserted, 987
 - card.mac_addr, 986, 1153
 - comm.baud, 674
 - comm.halt, 675
 - comm.parity, 678
 - comm.pnp_option, 676
 - comm.stop_bits, 679
 - comm.type, 677
 - cutter.clean_cutter, 680
 - device.download_connection_timeout, 699
 - device.epi_legacy_mode, 700
 - device.friendly_name, 702
 - device.host_identification, 708
 - device.host_status, 709
 - device.jobs_print, 714
 - device.languages, 713, 715
 - device.orientation, 719
 - device.pnp_option, 721
 - device.uptime, 741
 - device.user_p1, 742
 - device.user_p2, 743
 - device.xml.enable, 747
 - display.text, 751, 752
 - external_wired.ip.arp_interval, 917
 - external_wired.check, 915
 - external_wired.ip.addr, 916
 - external_wired.ip.default_addr.enable address printer, 918
 - external_wired.ip.dhcp.cid_all, 919, 940
 - external_wired.ip.dhcp.cid_enable, 920
 - external_wired.ip.dhcp.cid_prefix, 921
 - external_wired.ip.dhcp.cid_suffix, 922
 - external_wired.ip.dhcp.cid_type, 923
 - external_wired.ip.gateway, 924
 - external_wired.ip.netmask, 925

- external_wired.ip.port, 926
- external_wired.ip.timeout.value, 929, 961
- external_wired.ip.v6.addr, 930
- external_wired.ip.v6.gateway, 931
- external_wired.ip.v6.prefix_length, 932
- external_wired.mac_addr, 933
- external_wired.mac_raw, 934
- file.dir, 765, 766, 771
- file.type, 767
- head.latch, 770
- ip.dhcp.lease.last_attempt, 1003
- interface.network.active.gateway, 772, 775, 812
- interface.network.active.ip_addr, 776, 789
- interface.network.active.mac_addr, 777
- interface.network.active.mac_raw, 778
- interface.network.active.netmask, 779
- interface.network.active.protocol, 780
- internal_wired.ip.arp_interval, 937
- internal_wired.auto_switchover, 935
- internal_wired.ip.addr, 936
- internal_wired.ip.default_addr.enable address printer, 938
- internal_wired.ip.dhcp.cache_ip, 939
- internal_wired.ip.dhcp.cid_enable, 941
- internal_wired.ip.dhcp.cid_prefix, 942
- internal_wired.ip.dhcp.cid_suffix, 943
- internal_wired.ip.dhcp.cid_type, 944
- internal_wired.ip.dhcp.lease.last_attempt, 945
- internal_wired.ip.dhcp.lease.length, 946
- internal_wired.ip.dhcp.lease.server, 947
- internal_wired.ip.dhcp.lease.time_left, 948
- internal_wired.ip.dhcp.option12, 949
- internal_wired.ip.dhcp.option12_format, 950
- internal_wired.ip.dhcp.option12_value, 951
- internal_wired.ip.dhcp.requests_per_session, 952
- internal_wired.ip.dns.servers, 953
- internal_wired.ip.gateway, 954
- internal_wired.ip.netmask, 955
- internal_wired.ip.port, 956, 1137
- internal_wired.ip.protocol, 959
- internal_wired.ip.timeout.enable, 928, 960
- internal_wired.mac_addr, 962
- internal_wired.mac_raw, 963
- ip.active_network, 988
- ip.addr, 989
- ip.bootp.enable, 991
- ip.dhcp.cache_ip, 993, 995
- ip.dhcp.cid_all, 996
- ip.dhcp.cid_enable, 997
- ip.dhcp.cid_prefix, 998
- ip.dhcp.cid_suffix, 999
- ip.dhcp.cid_type, 1000
- ip.dhcp.cid_value, 1001
- ip.dhcp.enable, 1002
- ip.dhcp.lease.last_attempt, 1124
- ip.dhcp.lease.server, 1004
- ip.dhcp.lease.time_left, 1005
- ip.dhcp.option12, 1006
- ip.dhcp.option12_format, 1007
- ip.dhcp.option12_value, 1008
- ip.dhcp.request_timeout, 1009
- ip.dhcp.requests_per_session, 1010
- ip.dhcp.session_interval, 1011, 1012
- ip.dns.domain, 1013
- ip.dns.servers, 1014
- ip.ftp.enable, 1015
- ip.ftp.execute_file, 1016
- ip.gateway, 1018
- ip.http.enable, 811, 813, 814, 815, 816, 817, 820, 821, 822, 823, 824, 836, 871, 872, 873, 874, 875, 876, 877, 878, 879, 1019, 1020, 1021, 1023, 1099, 1157, 1182, 1183
- ip.lpd.enable, 1026
- ip.mac_raw, 1027
- ip.mirror.auto, 1029
- ip.mirror.error_retry, 1030
- ip.mirror.feedback.auto, 1031
- ip.mirror.feedback.freq, 1032
- ip.mirror.feedback.odometer, 1033
- ip.mirror.feedback.path, 1034
- ip.mirror.fetch, 1035
- ip.mirror.freq, 1036
- ip.mirror.freq_hours, 1037
- ip.mirror.last_error, 1038
- ip.mirror.last_time, 1039
- ip.mirror.password, 1041
- ip.mirror.reset_delay, 1043
- ip.mirror.server, 1044
- ip.mirror.success, 1045
- ip.mirror.success_time, 1046
- ip.mirror.username, 1047
- ip.mirror.version, 1048
- ip.netmask, 1049
- ip.pop3.enable, 1050
- ip.pop3.password, 1051
- ip.pop3.poll, 1052
- ip.pop3.server_addr, 1053
- ip.pop3.username, 1054
- ip.port, 1055, 1058
- ip.primary_network, 1059
- ip.smtp.domain, 1060
- ip.smtp.enable, 1061
- ip.smtp.server_addr, 1062
- ip.snmp.enable, 1066
- ip.snmp.get_community_name, 1063, 1065
- ip.snmp.set_community_name, 1064
- ip.tcp.enable, 825, 1068

- ip.telnet.enable, 1067
- ip.udp.enable, 1069
- media.cartridge.part_number, 790
- media.media_low.external, 794
- media.media_low.warning, 795
- media.present.cut_amount, 796
- media.present.cut_margin, 801
- media.present.length_addition, 798
- media.present.loop_length, 799
- media.present.loop_length_max, 800
- media.present.present_timeout, 802
- media.present.present_type, 803
- media.printmode, 804
- media.speed, 806
- memory.flash_free, 807
- memory.flaxh_size, 808
- memory.ram_free, 809
- memory.ram_size, 810
- odometer.headclean, 825
- odometer.headnew, 826
- odometer.media_marker_count, 828
- odometer.media_marker_count1, 828
- odometer.media_marker_count2, 829
- odometer.retracts_count, 830
- odometer.total_print_length, 831
- print.tone, 837
- wlan.adhocautomode, 1101
- wlan.adhocchannel, 1102
- wlan.associated, 1103
- wlan.auth_type, 1104
- wlan.bssid, 1104, 1105, 1165
- wlan.channel, 1106
- wlan.channel_mask, 1107
- wlan.current_tx.rate, 1109
- wlan.encryption_index, 1110
- wlan.encryption_key1, 1111
- wlan.encryption_key2, 1111
- wlan.encryption_key3, 1111
- wlan.encryption_key4, 1111
- wlan.encryption_mode, 1112
- wlan.essid, 1113
- wlan.firmware_version, 1114
- wlan.ip.addr, 1115
- wlan.ip.arp_interval, 1116
- wlan.ip.default_addr.enable address printer, 1117
- wlan.ip.dhcp.cache_ip, 1118
- wlan.ip.dhcp.cid_all, 1119
- wlan.ip.dhcp.cid_enable, 1120
- wlan.ip.dhcp.cid_prefix, 1121
- wlan.ip.dhcp.cid_suffix, 1122
- wlan.ip.dhcp.cid_type, 1123
- wlan.ip.dhcp.lease.length, 1125
- wlan.ip.dhcp.lease.server, 1126
- wlan.ip.dhcp.lease.time_left, 1127
- wlan.ip.dhcp.option12, 1128
- wlan.ip.dhcp.option12_format, 1129
- wlan.ip.dhcp.option12_value, 1130
- wlan.ip.dhcp.request_timeout, 1131
- wlan.ip.dhcp.requests_per_session, 1132
- wlan.ip.dhcp.session_interval, 1133
- wlan.ip.dns.servers, 1134
- wlan.ip.gateway, 1135
- wlan.ip.netmask, 1136
- wlan.ip.protocol, 1140
- wlan.ip.timeout.enable, 1141
- wlan.ip.timeout.value, 1142
- wlan.keep_alive.enable, 1143
- wlan.keep_alive.timeout, 1144
- wlan.kerberos.kdc, 1145
- wlan.kerberos.mode, 1146
- wlan.kerberos.password, 1147
- wlan.kerberos.realm, 1148
- wlan.kerberos.username, 1149
- wlan.leap_mode, 1150
- wlan.leap_password, 1151
- wlan.leap_username, 1152
- wlan.mac_raw, 1154
- wlan.operating_mode, 1155
- wlan.password, 1156
- wlan.preamble, 1158
- wlan.private_key_password, 1159
- wlan.roam.interchannel_delay, 1161
- wlan.roam.interval, 1162
- wlan.roam.max_fail, 1164
- wlan.roam.rssid, 1165
- wlan.roam.signal, 1166
- wlan.security, 1167
- wlan.signal_noise, 1174
- wlan.signal_quality, 1175
- wlan.signal_strength, 1176
- wlan.station_name, 1177
- wlan.tx_power, 1178
- wlan.tx_rate, 1179
- wlan.username, 1181
- wlan.wep.auth_type, 1184
- wlan.wep.index, 1185
- wlan.wep.key_format, 1191
- wlan.wep.key1, 1186
- wlan.wep.key2, 1187
- wlan.wep.key3, 1188
- wlan.wep.key4, 1189
- wlan.wpa.psk, 1190
- wlanroam.max_chan_scan_time, 1163
- xxx, 659, 696, 716, 717, 729, 730, 732, 733, 735, 736, 737, 738, 870, 981
- XXXXX.XXXXX, 698, 718, 720, 726, 731, 740, 748, 749, 750, 753, 754, 755, 756, 757, 758,

- 759, 760, 761, 762, 763, 769, 773, 774, 781, 782, 783, 784, 785, 786, 787, 788, 818, 834, 835, 900, 901, 902, 903, 904, 905, 907, 910, 957, 992, 1017, 1056, 1092, 1093, 1094, 1095, 1096, 1097, 1100, 1138, 1180
- getvar command, 634, 912, 968
- GETVAR ZBI command, 609
- GOTO/GOSUB ZBI command, 506
- graphic
 - box, 209
 - circle, 211
 - diagonal line, 212
 - ellipse, 213
 - field, 214
 - recall, 375
 - symbol, 216
- graphic field, 214
- graphics
 - download, 173, 180
 - erase download, 184
 - upload, 241
- graphing sensor calibration, 257

H

- HANDLEEVENT ZBI command, 554
- hardware version of RFID reader, 851
- head test
 - fatal, 268
 - interval, 276
 - non-fatal, 269
- head test fatal, 268
- head test interval, 276
- head test non-fatal, 269
- head.latch, 770
- HEXTOINT ZBI command, 593
- host
 - directory list, 239
 - graphic, 220
 - identification, 222
 - RAM status, 223
 - status return, 232
- host directory list, 239
- host graphic, 220
- host identification, 222
- host linked font list, 236
- host query, 224, 365
- host RAM status, 223
- host status return, 232
- host verification command (^HV), 238
- ~HQ Host Query, 365
- HTTP protocol, 811, 813, 814, 815, 816, 817, 820, 821, 822, 823, 824, 836, 871, 872, 873, 874, 875, 876, 877, 878, 879, 1019, 1020, 1021, 1023, 1099, 1157, 1182, 1183
- IF statements (ZBI), 503
- image
 - load, 246
 - move, 247
 - save, 248
- image load, 246
- image move, 247
- image save, 248
- INBYTE ZBI command, 523
- industrial 2 of 5, 112
- initialize Flash memory, 251
- input and output commands (ZBI)
 - ACCEPT, 518
 - CLIENTSOCKET, 517
 - CLOSE, 513
 - DATAREADY, 514
 - description, 510
 - INBYTE, 523
 - INPUT, 520
 - OPEN, 512
 - OUTBYTE, 522
 - PRINT, 521
 - READ, 524
 - SEARCHTO\$, 526
 - SERVERCLOSE, 516
 - SERVERSOCKET, 515
 - WRITE, 525
- INPUT ZBI command, 520
- INSERTROW ZBI command, 596
- interface.network.active.gateway, 772, 775, 812
- interface.network.active.ip_addr, 776, 789
- interface.network.active.mac_addr, 777
- interface.network.active.mac_raw, 778
- interface.network.active.netmask, 779
- interface.network.active.protocol, 780
- interleaved
 - 2 of 5, 66
- internal wired gateway address
 - change, 954
- internal wired subnet mask address
 - enable or disable, 955
- internal wired timeout enable, 928, 960
- internal wired.ip.timeout enable, 928, 960
- internal_wired.auto_switchover, 935
- internal_wired.ip.addr, 936
- internal_wired.ip.arp_interval, 937
- internal_wired.ip.default_addr.enable, 938
- internal_wired.ip.dhcp.cache_ip, 939
- internal_wired.ip.dhcp.cid_enable, 941
- internal_wired.ip.dhcp.cid_prefix, 942
- internal_wired.ip.dhcp.cid_suffix, 943
- internal_wired.ip.dhcp.cid_type, 944
- internal_wired.ip.dhcp.lease.last_attempt, 945

- internal_wired.ip.dhcp.lease.length, 946
 - internal_wired.ip.dhcp.lease.server, 947
 - internal_wired.ip.dhcp.lease.time_left, 948
 - internal_wired.ip.dhcp.option12, 949
 - internal_wired.ip.dhcp.option12_format, 950
 - internal_wired.ip.dhcp.option12_value, 951
 - internal_wired.ip.dhcp.requests_per_session, 952
 - internal_wired.ip.dns.servers, 953
 - internal_wired.ip.gateway, 954
 - internal_wired.ip.netmask, 955
 - internal_wired.ip.port, 956
 - internal_wired.ip.protocol, 959
 - internal_wired.ip.timeout.enable, 928, 960
 - internal_wired.mac_addr, 962
 - internal_wired.mac_raw, 963
 - internal.wired.mac_addr, 962
 - international font
 - change, 153
 - international mode
 - setting via ^WS, 450
 - Introduction to Zebra Basic Interpreter (ZBI), 464
 - INTTOHEX\$ ZBI command, 592
 - IP address
 - printer, 916, 936, 989, 1115
 - setting via ip.addr, 1059
 - ip.active_network, 988
 - ip.addr, 989
 - ip.arp_interval, 990
 - ip.bootp.enable, 991
 - ip.dhcp.cache_ip, 993, 995
 - ip.dhcp.cid_all, 919, 940, 996
 - ip.dhcp.cid_enable, 997
 - ip.dhcp.cid_prefix, 998
 - ip.dhcp.cid_suffix, 999
 - ip.dhcp.cid_type, 1000
 - ip.dhcp.cid_value, 1001
 - ip.dhcp.enable, 1002
 - ip.dhcp.lease.last_attempt, 1003, 1124
 - ip.dhcp.lease.server, 1004
 - ip.dhcp.lease.time_left, 1005
 - ip.dhcp.option12, 1006
 - ip.dhcp.option12_format, 1007
 - ip.dhcp.option12_value, 1008
 - ip.dhcp.request_timeout, 1009
 - ip.dhcp.requests_per_session, 1010
 - ip.dhcp.session_interval, 1011, 1012
 - ip.dns.domain, 1013
 - ip.dns.servers, 1014
 - ip.ftp.enable, 1015
 - ip.ftp.execute_file, 1016
 - ip.gateway, 924, 1018
 - ip.http.enable, 811, 813, 814, 815, 816, 817, 820, 821, 822, 823, 824, 836, 871, 872, 873, 874, 875, 876, 877, 878, 879, 1019, 1020, 1021, 1023, 1099, 1157, 1182, 1183
 - ip.lpd.enable, 1026
 - ip.mac_raw, 1027
 - ip.mirror.auto, 1029
 - ip.mirror.error_retry, 1030
 - ip.mirror.feedback.auto, 1031
 - ip.mirror.feedback.freq, 1032
 - ip.mirror.feedback.odometer, 1033
 - ip.mirror.feedback.path, 1034
 - ip.mirror.fetch, 1035
 - ip.mirror.freq, 1036
 - ip.mirror.freq_hours, 1037
 - ip.mirror.last_error, 1038
 - ip.mirror.last_time, 1039
 - ip.mirror.password, 1041
 - ip.mirror.reset_delay, 1043
 - ip.mirror.server, 1044
 - ip.mirror.success, 1045
 - ip.mirror.success_time, 1046
 - ip.mirror.username, 1047
 - ip.mirror.version, 1048
 - ip.netmask, 1049
 - ip.pop3.enable, 1050
 - ip.pop3.password, 1051
 - ip.pop3.poll, 1052
 - ip.pop3.server_addr, 1053
 - ip.pop3.username, 1054
 - ip.port, 926, 956, 1055, 1058, 1137
 - ip.primary_network, 1059
 - ip.smtp.domain, 1060
 - ip.smtp.enable, 1061
 - ip.smtp.server_addr, 1062
 - ip.snmp.get_community_name, 1063, 1065
 - ip.snmp.server_addr, 1066
 - ip.snmp.set_community_name, 1063, 1064, 1065
 - ip.tcp.enable, 1068
 - ip.telnet.enable, 1067
 - ip.udp.enable, 1069
 - ISERRORd ZBI command, 558
- ## K
- Kerberos
 - password, 1147
 - realm, 1148
 - username, 1149
 - Kerberos network authentication protocol, 1146
 - key distribution center (KDC), 1145
 - key rotation
 - firmware version required, 457, 1171
 - kill battery, 281
 - kill password
 - set via ^RQ, 407
 - set via ^RZ, 427
 - kiosk values, 286

L

label

- maximum length, 302
- reverse print, 293
- shift, 294
- top, 295

label home, 290, 291

label length, 292

- set, 266

language

- define, 283

LCASE\$ ZBI command, 570

LEAP mode

- set password via wlan.leap_password, 1151
- set user name via wlan.leap_username'setvar
wlan.leap_username, 1152
- setting using ZPL, 445
- setting via wlan.leap_mode, 1150

LEAP password, 1151

LEAP user name, 1152

LEN ZBI command, 584

LET

- ZBI command, 494

Liability, 2

linked font

- host list, 236

LIST ZBI command, 472

lock RFID tag

- Gen 2, 427

lock RFID tag (not Gen 2 tags), 398

lock RFID tag memory or passwords, 403

log file for RFID, 385

LOGMARS, 118

LPD protocol setting, 1026

LTRIM\$ ZBI command, 572

M

^MA Set Maintenance Alerts, 296

MAC address

- access point, 1104, 1105, 1165
- retrieve via external_wired.mac_addr, 933
- retrieve via internal_wired.mac_addr, 962

maintenance alerts, setting, 296

map clear, 298

math functions

- description, 585

math functions (ZBI)

- HEXTOINT, 593
- INTTOHEX\$, 592
- MAX, 587
- MAXNUM, 589
- MIN, 588
- MOD, 590

STR\$, 586

VAL, 591

MAX ZBI command, 587

maximum label length, 302

MAXNUM ZBI command, 589

media

- darkness, 299
- feed, 300
- ordering, 44
- tracking, 305
- type, 308

media calibration, setting dynamic, 376

media darkness, 299

media sensor

- set, 353

media sensor calibration, 253

- set, 253

media tracking, 305

media type, 308

media.cartridge.part_number, 790

media.cut_now, 791

media.darkness_mode, 792

media.media_low.external, 794

media.media_low.warning, 795

media.present.cut_amount, 796

media.present.cut_margin, 801

media.present.eject, 797

media.present.length_addition, 798

media.present.loop_length, 799

media.present.loop_length_max, 800

media.present.present_timeout, 802

media.present.present_type, 803

media.printmode, 804

media.speed, 806

memory bank locking (RFID), 403

memory letter designation

- change, 157

memory.flash_free, 807

memory.flash_size, 808

memory.ram_free, 809

memory.ram_size, 810

^MI Set Maintenance Information Message, 301

MIN ZBI command, 588

mirror image

- printing, 325

MOD ZBI command, 590

mode

- set ZPL mode, 358

mode protection, 306

model number of RFID reader, 852

modify head warning, 311

motion in RFID label, 405

MSI, 120

multiple field origin locations, 195

N

- network
 - connect, 313
 - ID number, 316
- network boot command, 435
- network configuration label
 - print, 446
- network connect, 313
- network ID number, 316
- network operating mode, 1155
- network printers
 - set all transparent, 317
- network settings
 - setting via ZPL, 443
- NEW ZBI command, 469
- number of retries for block (^RR), 409

O

- object delete, 244
- odometer
 - ~WQ, 365
- odometer related commands
 - ^JH, 258
 - ^MA, 296
 - ^MI, 301
 - ~HQ, 224
 - odometer.headclean, 825
 - odometer.headnew, 826
 - odometer.label_dot_length, 827
 - odometer.media_marker_count1, 828
 - odometer.media_marker_count2, 829
 - odometer.total_print_length, 831
- odometer.headclean, 825
- odometer.headnew, 826
- odometer.label_dot_length, 827
- odometer.media_marker_count, 828, 829
- odometer.media_marker_count1, 828
- odometer.media_marker_count2, 829
- odometer.retracts_count, 830
- odometer.total_print_length, 831
- offset for real time clock
 - set, 348
- ON ERROR ZBI command, 563
- OPEN ZBI command, 512
- option 61, 923, 944, 1000, 1123
 - CID prefix, 921, 942
 - enable, 920, 941
 - external_wired.ip.dhcp.cid_enable, 920
 - internal_wired.ip.dhcp.cid_enable, 941
 - ip.dhcp.cid_enable, 997
 - ip.dhcp.cid_prefix, 921, 942, 998, 1121
 - wlan.ip.dhcp.cid_enable, 1120
- optional memory

- reset, 252
- ordering ribbon and media, 44
- OUTBYTE ZBI command, 522

P

- password
 - define, 285
 - set wireless password via ^WP, 447
- password for RFID tag, 427
- password locking (RFID), 403
- pause
 - programmable, 328
- pause format, 270
- PDF417, 77
 - consideration for ^FD, 80
- permalock RFID tag memory or passwords, 403
- permanently lock Gen 2 tag data, 427
- POP3
 - mailbox, 1050
 - mailbox password, 1051
 - poll interval, 1052
 - username, 1054
- POP3 server
 - IP address, 1053
- POS ZBI command, 583
- POSTNET, 149
- power on
 - reset, 272
- preamble length
 - radio, 1158
- pre-shared key value, 1190
- primary network device
 - selection by ^NC, 312
- primary/secondary device
 - setting via ZPL, 437
- print
 - start, 333
 - width, 334
- print mode, 303
 - selection via ZPL, 303
- print orientation, 327
- print quantity, 329
- print rate, 331
- print start, 333
- print width, 334
- PRINT ZBI command, 521
- print.tone, 837
- printer
 - sleep, 378
- printer IP address, 916, 936, 989, 1115
- printer name
 - define, 284
- printer sleep, 378
- Printers, ZBI Keys, & ZBI Versions, 465

- printhead resistance
 - set, 352
- printing mirror image of label, 325
- private key password, 1159
- programmable pause, 328
- programming position
 - set manually using SGD, 844

Q

- QR code
 - normal mode, 129
- quantity
 - print, 329

R

- read power
 - change using SGD, 847
- read RFID data
 - read or write RFID format (^RF), 398
 - SGD to read data, 857
 - SGD to set data to read, 856
- read RFID tag
 - read RFID tag (^RT), 418
- read unique RFID chip serialization, 420
- READ ZBI command, 524
- real time clock
 - set language, 343
 - set mode, 343
- real time clock date format
 - select, 282
- real time clock time format
 - select, 282
- recall format, 374
- recall graphic, 375
- REDIM ZBI command, 595
- region code, 853
- REGISTEREVENT ZBI command, 551
- relative mode for RFID, 413
- REM ZBI command, 470
- RENUM ZBI command, 474
- REPEAT\$ ZBI command, 573
- report RFID encoding results, 422
- reprint
 - after error, 280
 - applicator, 330
- reset
 - power on, 272
- reset advanced counter, 335
- reset optional memory, 252
- reset wireless radio card and print server, 449
- RESTART ZBI command, 480
- return data to host computer (^HV), 238
- return RFID data log to host, 385

- RFID
 - adaptive antenna element selection, 838
 - adaptive antenna selection
 - enable using ZPL, 409
 - antenna sweep, 839
 - change read power using ZPL (^RW), 423
 - detect multiple tags (^RN), 406
 - display tag data
 - SGD, 855
 - enable motion (^RM), 405
 - hop table version, 843
 - number of retries for block (^RR), 409
 - RFID test
 - SGD command, 862
 - verify write operation (^WV), 432
- RFID counters
 - reset valid label counter by SGD, 832
 - reset void counter by SGD, 833
 - resetting by ZPL, 335
- RFID mode
 - selection via ZPL, 303
- RFID password locking, 403
- RFID programming position
 - setting via ZPL, 413
- RFID reader
 - country code, 840
 - firmware version, 850
 - hardware version, 851
 - model number, 852
 - region code, 853
- RFID setup command (^RS), 411
- RFID tag ID command (^RI), 402
- RFID tag types, 415, 867
- RFID test
 - SGD to set data to read, 863
 - SGD to set data to test, 864
- ribbon
 - ordering, 44
- ribbon tension
 - set, 278
- ROWSIZE ZBI command, 598
- RTRIM\$ ZBI command, 574
- RUN ZBI command, 478
- running and debugging commands (ZBI)
 - ADDBREAK ZBI command, 485
 - BREAK ZBI command, 484
 - CTRL-C ZBI command, 479
 - DEBUG ZBI command, 482
 - DELBREAK ZBI command, 486
 - description, 476
 - RESTART ZBI command, 480
 - RUN ZBI command, 478
 - STEP ZBI command, 481
 - TRACE ZBI command, 483

ZPL ZBI command, 488

S

sales, 44

scalable font, 58, 1210

download Intellifont, 177

SEARCHTO\$ ZBI command, 526

select encoding, 338

sensor calibration

graphing, 257

serial communications

set, 336

serialization, 420

serialization data, 345

serialization field

standard ^FD string, 339

SERVERCLOSE ZBI command, 516

SERVERSOCKET ZBI command, 515

set all network printers transparent, 317

set auxiliary port, 264

set battery condition, 256

set darkness, 337

set dots

millimeter, 267

set dots per millimeter, 267

set dynamic media calibration, 376

set label length, 266

set maintenance alerts, 296

set maintenance information message, 301

set RFID tag or kill password (^RZ), 427

set serial communications, 336

set units of measurements, 309

set up RFID information (^RS), 411

set ZPL mode, 358

Set/Get/Do interactions

description, 607

Set/Get/Do interactions (ZBI)

GETVAR, 609

SETVAR, 608

SETERR ZBI command, 561

setvar

bluetooth.afh_map, 971

bluetooth.afh_mode, 973

bluetooth.authentication, 974

bluetooth.bluetooth_pin, 975

bluetooth.discoverable, 977

bluetooth.enable, 978

bluetooth.friendly_name, 979

bluetooth.radio_auto_baud, 982

comm.baud, 674

comm.halt, 675

comm.parity, 678

comm.pnp_option, 676

comm.stop_bits, 679

comm.type, 677

cutter.clean_cutter, 680

device.command_override, 693

device.download_connection_timeout, 699

device.epi_legacy_mode, 700

device.friendly_name, 702

device.languages, 713, 715

device.orientation, 719

device.pnp_option, 721

device.reset, 727

device.uptime, 741

device.user_p1, 742

device.user_p2, 743

device.xml.enable, 747

external_wired.check, 915

external_wired.ip.addr, 916, 918

external_wired.ip.arp_interval, 917

external_wired.ip.dhcp.cid_all, 919, 940

external_wired.ip.dhcp.cid_enable, 920

external_wired.ip.dhcp.cid_prefix, 921

external_wired.ip.dhcp.cid_suffix, 922

external_wired.ip.dhcp.cid_type, 923

external_wired.ip.gateway, 924

external_wired.ip.netmask, 925

external_wired.ip.port, 926

external_wired.ip.timeout value, 929, 961

file.dir, 765, 766, 771

file.run, 768

file.type, 767

head.latch, 770

internal_wired.auto_switchover, 935

internal_wired.ip.addr, 936, 938

internal_wired.ip.arp_interval, 937

internal_wired.ip.dhcp.cid_enable, 941

internal_wired.ip.dhcp.cid_prefix, 942

internal_wired.ip.dhcp.cid_suffix, 943

internal_wired.ip.dhcp.cid_type, 944

internal_wired.ip.dhcp.option12, 949

internal_wired.ip.dhcp.option12_format, 950

internal_wired.ip.dhcp.option12_value, 951

internal_wired.ip.dhcp.requests_per_session,
952

internal_wired.ip.gateway, 954

internal_wired.ip.netmask, 955

internal_wired.ip.port, 956, 1137

internal_wired.ip.protocol, 959

internal_wired.ip.timeout enable, 928, 960

ip.active_network, 988

ip.addr, 989

ip.arp_interval, 990

ip.bootp.enable, 991

ip.dhcp.cid_all, 996

ip.dhcp.cid_enable, 997

ip.dhcp.cid_prefix, 998

ip.dhcp.cid_suffix, 999
 ip.dhcp.cid_type, 1000
 ip.dhcp.cid_value, 1001
 ip.dhcp.enable, 1002
 ip.dhcp.option12, 1006
 ip.dhcp.option12_format, 1007
 ip.dhcp.option12_value, 1008
 ip.dhcp.request_timeout, 1009
 ip.dhcp.requests_per_session, 1010
 ip.dhcp.session_interval, 1011, 1012
 ip.dns.domain, 1013
 ip.ftp.enable, 1015
 ip.ftp.execute_file, 1016
 ip.gateway, 1018
 ip.http.enable, 811, 813, 814, 815, 816, 817, 820, 821, 822, 823, 824, 836, 871, 872, 873, 874, 875, 876, 877, 878, 879, 1019, 1020, 1021, 1023, 1099, 1157, 1182, 1183
 ip.lpd.enable, 1026
 ip.mirror.auto, 1029
 ip.mirror.error_retry, 1030
 ip.mirror.feedback.auto, 1031
 ip.mirror.feedback.freq, 1032
 ip.mirror.feedback.odometer, 1033
 ip.mirror.feedback.path, 1034
 ip.mirror.fetch, 1035
 ip.mirror.freq, 1036
 ip.mirror.freq_hours, 1037
 ip.mirror.password, 1041
 ip.mirror.reset_delay, 1043
 ip.mirror.server, 1044
 ip.mirror.success, 1045
 ip.mirror.success_time, 1046
 ip.mirror.username, 1047
 ip.netmask, 1049
 ip.pop3.enable, 1050
 ip.pop3.password, 1051
 ip.pop3.poll, 1052
 ip.pop3.server_addr, 1053
 ip.pop3.username, 1054
 ip.port, 1055, 1058
 ip.primary_network, 1059
 ip.smtp.domain, 1060
 ip.smtp.enable, 1061
 ip.smtp.server_addr, 1062
 ip.snmp.enable, 1066
 ip.snmp.get_community_name, 1063, 1065
 ip.snmp.set_community_name, 1064
 ip.tcp.enable, 1068
 ip.telnet.enable, 1067
 ip.udp.enable, 1069
 media.cut_now, 791
 media.darkness_mode, 792
 media.media_low.warning, 795
 media.present.cut_amount, 796
 media.present.cut_margin, 801
 media.present.eject, 797
 media.present.length_addition, 798
 media.present.loop_length, 799
 media.present.loop_length_max, 800
 media.present.present_timeout, 802
 media.present.present_type, 803
 media.printmode, 804
 media.speed, 806
 odometer.headclean, 825
 odometer.headnew, 826
 odometer.media_marker_count, 828
 odometer.media_marker_count1, 828
 odometer.media_marker_count2, 829
 odometer.retracts_count, 830
 print.tone, 837
 wlan.adhocautomode, 1101
 wlan.adhocchannel, 1102
 wlan.auth_type, 1104
 wlan.channel_mask, 1107
 wlan.encryption_index, 1110
 wlan.encryption_key1, 1111
 wlan.encryption_key2, 1111
 wlan.encryption_key3, 1111
 wlan.encryption_key4, 1111
 wlan.encryption_mode, 1112
 wlan.essid, 1113
 wlan.ip.addr, 1115, 1117
 wlan.ip.arp_interval, 1116
 wlan.ip.dhcp.cid_all, 1119
 wlan.ip.dhcp.cid_enable, 1120
 wlan.ip.dhcp.cid_prefix, 1121
 wlan.ip.dhcp.cid_suffix, 1122
 wlan.ip.dhcp.cid_type, 1123
 wlan.ip.dhcp.option12, 1128
 wlan.ip.dhcp.option12_format, 1129
 wlan.ip.dhcp.option12_value, 1130
 wlan.ip.dhcp.request_timeout, 1131
 wlan.ip.dhcp.requests_per_session, 1132
 wlan.ip.dhcp.session_interval, 1133
 wlan.ip.gateway, 1135
 wlan.ip.netmask, 1136
 wlan.ip.protocol, 1140
 wlan.ip.timeout enable, 1141
 wlan.ip.timeout value, 1142
 wlan.keep_alive.enable, 1143
 wlan.keep_alive.timeout, 1144
 wlan.kerberos.kdc, 1145
 wlan.kerberos.mode, 1146
 wlan.kerberos.password, 1147
 wlan.kerberos.realm, 1148
 wlan.kerberos.username, 1149
 wlan.leap_mode, 1150

- wlan.leap_password, 1151
 - wlan.operating_mode, 1155
 - wlan.password, 1156
 - wlan.preamble, 1158
 - wlan.private_key_password, 1159
 - wlan.roam.interchannel_delay, 1161
 - wlan.roam.interval, 1162
 - wlan.roam.max_chan_scan_time, 1163
 - wlan.roam.max_fail, 1164
 - wlan.roam.rssid, 1165
 - wlan.roam.signal, 1166
 - wlan.security, 1167
 - wlan.station_name, 1177
 - wlan.tx_power, 1178
 - wlan.tx_rate, 1179
 - wlan.username, 1181
 - wlan.wep.auth_type, 1184
 - wlan.wep.index, 1185
 - wlan.wep.key_format, 1191
 - wlan.wep.key1, 1186
 - wlan.wep.key2, 1187
 - wlan.wep.key3, 1188
 - wlan.wep.key4, 1189
 - wlan.wpa.psk, 1190
 - xxx, 659, 696, 716, 717, 729, 730, 732, 733, 735, 736, 737, 738, 870, 981
 - XXXXX.XXXXX, 698, 718, 720, 726, 731, 740, 748, 749, 750, 753, 754, 755, 756, 757, 758, 759, 760, 761, 762, 763, 769, 773, 774, 781, 782, 783, 784, 785, 786, 787, 788, 818, 834, 835, 900, 901, 902, 903, 904, 905, 907, 910, 957, 992, 1017, 1056, 1092, 1093, 1094, 1095, 1096, 1097, 1100, 1138, 1180
 - setvar command, 633, 912, 967
 - SETVAR ZBI command, 608
 - SGD command structure, 635, 914, 969
 - SGTIN-96 standard
 - chip serialization, 420
 - programming example, 396
 - single signal mode
 - setting, 414
 - SLEEP ZBI command, 560
 - slew
 - home position, 323
 - slew given number
 - dot rows, 322
 - slew to home position, 323
 - SMTP IP address, 1062
 - SMTP parameters
 - setting via ZPL, 438
 - SMTP protocol, 1060, 1061
 - SNMP
 - get community, 1063, 1065
 - set community, 1064
 - SNMP parameters
 - setting via ZPL, 436
 - SNMP protocol, 1066
 - SNMP query, 1063, 1065
 - specify number of retries for block (^RR), 409
 - SPLIT ZBI command, 575
 - SPLITCOUNT ZBI command, 578
 - standard printer fonts, 1210
 - start print, 349
 - start ZBI, 261
 - STEP ZBI command, 481
 - STR\$ ZBI command, 586
 - string functions (ZBI)
 - CHR\$, 571
 - description, 569
 - EXTRACT\$, 580
 - LCASE\$, 570
 - LEN, 584
 - LTRIM\$, 572
 - POS, 583
 - REPEAT\$, 573
 - RTRIM\$, 574
 - SPLIT, 575
 - SPLITCOUNT, 578
 - UCASE\$, 579
 - SUB ZBI command, 507
 - subnet mask
 - change, 925, 955
 - subnet mask address
 - enable or disable, 1049
 - supported
 - printers, 465
 - symbol, 216, 219
 - systems (ZBI)
 - CLRERR, 562
 - description, 557
 - ISERRORd, 558
 - ON ERROR, 563
 - SETERR, 561
 - SLEEP, 560
 - TRIGGEREVENT, 559
- ## T
- tag calibration
 - using SGD, 854
 - using ZPL (^HR), 387
 - tag type
 - specify using SGD, 867
 - specify using ZPL, 412
 - TCP communication, 926, 956, 1055, 1058, 1137
 - TCP socket protocol, 1068
 - tear-off adjust position, 359
 - technical support, 44
 - TELNET protocol, 1067

terminate ZBI, 271
 text blocks, 360
 text properties
 advanced, 321
 tilde
 change, 163
 time and date functions
 description, 602
 time and date functions (ZBI)
 DATE, 605
 DATE\$, 603
 TIME, 606
 TIME\$, 604
 time for real time clock
 set, 355
 TIME ZBI command, 606
 TIME\$ ZBI command, 604
 timeout value, 929, 961
 timeout value for printer home page, 439
 TRACE ZBI command, 483
 transfer object, 361
 transmit rate
 setting via ^WR, 448
 TRIGGEREVENT ZBI command, 556, 559
 troubleshooting
 RFID test
 SGD command, 862
 true type font
 download, 178
 TXTLOAD ZBI command, 544

U

UCASE\$ ZBI command, 579
 UDP communication, 926, 956, 1055, 1058, 1137
 UDP socket protocol, 1069
 unbounded true type font
 download, 179
 unique RFID chip serialization, 420
 units of measurement
 set, 309
 UNREGISTEREVENT ZBI command, 553
 UPC/EAN extensions, 136
 UPC-A, 141
 UPC-E, 83
 update configuration, 277
 upload graphics, 241
 UPS maxicode, 105
 considerations for ^FD, 106
 use font name to call font, 60

V

V61, 1283
 V72, 1270, 1273, 1274, 1275, 1277

VAL ZBI command, 591
 valid RFID label counter
 reset by SGD, 832
 reset by ZPL, 335
 verify RFID write operation (^WV), 432
 void RFID label counter
 reset by SGD, 833
 reset by ZPL, 335

W

web authentication timeout value, 439
 web pages
 set timeout value, 439
 web server setting, 811, 813, 814, 815, 816, 817,
 820, 821, 822, 823, 824, 836, 871, 872, 873,
 874, 875, 876, 877, 878, 879, 1019, 1020,
 1021, 1023, 1099, 1157, 1182, 1183
 WEP key format, 1191
 WEP mode
 setting encryption index via ^WX, 453
 width
 print, 334
 wired equivalent privacy, 1185
 wired print server
 ^NB to set check for, 435
 wireless password
 setting via ^WP, 447
 Wireless Print Server
 ZPL commands, 1193, 1243
 wireless print server
 change network settings, 443
 wireless pulse and interval
 setting via ^WS, 450
 wireless radio card
 reset via ZPL, 449
 setting values via ^WS, 450
 wireless timeout enable, 1141
 wlan gateway address
 change, 1135
 wlan subnet mask address
 enable or disable, 1136
 wlan.adhocautomode, 1101
 wlan.adhocchannel, 1102
 wlan.associated, 1103
 wlan.auth_type, 1104
 wlan.bssid, 1105, 1164
 wlan.channel, 1106
 wlan.channel_mask, 1107
 wlan.current_tx_rate, 1109
 wlan.encryption_index, 1110
 wlan.encryption_key1, 1111
 wlan.encryption_key2, 1111
 wlan.encryption_key3, 1111
 wlan.encryption_key4, 1111

wlan.encryption_mode, 1112
 wlan.essid, 1113
 wlan.firmware_version, 1114
 wlan.ip.addr, 1115
 wlan.ip.arp_interval, 1116
 wlan.ip.default_addr.enable, 1117
 wlan.ip.dhcp.cache_ip, 1118
 wlan.ip.dhcp.cid_all, 1119
 wlan.ip.dhcp.cid_enable, 1120
 wlan.ip.dhcp.cid_prefix, 1121
 wlan.ip.dhcp.cid_suffix, 1122
 wlan.ip.dhcp.cid_type, 1123
 wlan.ip.dhcp.lease.length, 1125
 wlan.ip.dhcp.lease.server, 1126
 wlan.ip.dhcp.lease.time_left, 1127
 wlan.ip.dhcp.option12, 1128
 wlan.ip.dhcp.option12_format, 1129
 wlan.ip.dhcp.option12_value, 1130
 wlan.ip.dhcp.request_timeout, 1131
 wlan.ip.dhcp.requests_per_session, 1132
 wlan.ip.dhcp.session_interval, 1133
 wlan.ip.dns.servers, 1134
 wlan.ip.gateway, 1135
 wlan.ip.netmask, 1136
 wlan.ip.protocol, 1140
 wlan.ip.timeout enable, 1141
 wlan.ip.timeout value, 1142
 wlan.ip.timeout.enable, 1141
 wlan.keep_alive.enable, 1143
 wlan.keep_alive.timeout, 1144
 wlan.kerberos.kdc, 1145
 wlan.kerberos.mode, 1146
 wlan.kerberos.password, 1147
 wlan.kerberos.realm, 1148
 wlan.kerberos.username, 1149
 wlan.leap_mode, 1150
 wlan.leap_password, 1151
 wlan.leap_username, 1152
 wlan.leap.password, 1151
 wlan.leap.username, 1152
 wlan.mac_raw, 1154
 wlan.operating_mode, 1155
 wlan.password, 1156
 wlan.preamble, 1158
 wlan.private_key_password, 1159
 wlan.roam.interchannel_delay, 1161
 wlan.roam.interval, 1162
 wlan.roam.max_chan_scan_time, 1163
 wlan.roam.max_fail, 1164
 wlan.roam.rssid, 1165
 wlan.roam.signal, 1166
 wlan.security, 1167
 wlan.signal_noise, 1174
 wlan.signal_quality, 1175

wlan.signal_strength, 1176
 wlan.station_name, 1177
 wlan.tx_power, 1178
 wlan.tx_rate, 1179
 wlan.username, 1181
 wlan.wep.auth_type, 1184
 wlan.wep.index, 1185
 wlan.wep.key_format, 1191
 wlan.wep.key1, 1186
 wlan.wep.key2, 1187
 wlan.wep.key3, 1188
 wlan.wep.key4, 1189
 wlan.wpa.psk, 1190
 write AFI byte command (^WF), 429
 write data to tag
 via ^RQ, 407
 via ^RZ, 427
 write power
 change using SGD, 848
 write RFID format (^RF), 398
 write RFID tag (^WT), 430
 WRITE ZBI command, 525
 Writing ZBI Programs, 467

X

^XS Set Dynamic Calibration Defaults, 376
 xxxcommandname, 659, 696, 716, 717, 729, 730,
 732, 733, 735, 736, 737, 738, 870, 981
 XXXXX.XXXXX, 698, 718, 720, 726, 731, 740, 748,
 749, 750, 753, 754, 755, 756, 757, 758, 759,
 760, 761, 762, 763, 769, 773, 774, 781, 782,
 783, 784, 785, 786, 787, 788, 818, 834, 835,
 900, 901, 902, 903, 904, 905, 907, 910, 957,
 992, 1017, 1056, 1092, 1093, 1094, 1095,
 1096, 1097, 1100, 1138, 1180

Z

ZBI
 Command/Function Name description, 462
 function rules, 463
 start, 261
 terminate, 271
 ZBI character set, 1263
 ZBI commands
 ! (EXCLAMATION MARK), 471
 ACCEPT, 518
 ADDBREAK, 485
 AUTONUM, 473
 AUXPORT_GETPIN, 567
 AUXPORT_RELEASEPIN, 568
 AUXPORT_SETPIN, 566
 AUXPORT_STEALPIN, 565
 BREAK, 484

CHR\$, 571
 CLIENTSOCKET, 517
 CLOSE, 513
 CLRERR, 562
 COLUMNSIZE, 599
 CSVLOAD, 541
 CSVSTORE, 543
 CTRL-C, 479
 DATAREADY, 514
 DATE, 605
 DATE\$, 603
 DEBUG, 482
 DELBREAK, 486
 DELETE, 539
 DELROW, 597
 DIR, 538
 DO loops, 504
 ECHO, 475
 END, 509
 EXIT, 508
 EXTRACT\$, 580
 FIND, 600
 FOR loops, 505
 GETVAR, 609
 GOTO/GOSUB, 506
 HANDLEEVENT, 554
 HEXTOINT, 593
 IF statements, 503
 INBYTE, 523
 INPUT, 520
 INSERTROW, 596
 INTTOHEX\$, 592
 ISERRORd, 558
 LCASE\$, 570
 LEN, 584
 LET, 494
 LIST, 472
 LOAD, 537
 LTRIM\$, 572
 MAX, 587
 MAXNUM, 589
 MIN, 588
 MOD, 590
 NEW, 469
 ON ERROR, 563
 OPEN, 512
 OUTBYTE, 522
 POS, 583
 PRINT, 521
 READ, 524
 REDIM, 595
 REGISTEREVENT, 551
 REM, 470
 RENUM, 474
 REPEAT\$, 573
 RESTART, 480
 ROWSIZE, 598
 RTRIM\$, 574
 RUN, 478
 SEARCHTO\$, 526
 SERVERCLOSE, 516
 SERVERSOCKET, 515
 SETERR, 561
 SETVAR, 608
 SLEEP, 560
 SPLIT, 575
 SPLITCOUNT, 578
 STEP, 481
 STORE, 536
 STR\$, 586
 SUB, 507
 TIME, 606
 TIME\$, 604
 TRACE, 483
 TRIGGEREVENT, 556, 559
 TXTLOAD, 544
 TXTSTORE, 545
 UCASE\$, 579
 UNREGISTEREVENT, 553
 VAL, 591
 WRITE, 525
 ZBI Key Names, 549
 ZPL, 488
 ZBI keys, 465
 ZBI printers, 465
 ZBI versions, 465
 1.0 through 1.5, 465
 2.0 and higher, 465
 zbi.control.add_breakpoint, 880
 zbi.control.break, 881
 zbi.control.clear_breakpoints, 882
 zbi.control.delete_breakpoint, 883
 zbi.control.line_number, 884
 zbi.control.restart, 885
 zbi.control.run, 886
 zbi.control.step, 887
 zbi.control.terminate, 888
 zbi.control.variable_name, 889
 zbi.control.variable_value, 890
 zbi.key, 891
 zbi.last_error, 892
 zbi.reseller_key, 893
 zbi.revision, 894
 zbi.running_program_name, 895
 zbi.start_info.execute, 896
 zbi.start_info.file_name, 897
 zbi.start_info.memory_alloc, 898
 zbi.state, 899

Zebra Programming Language (ZPL II)

- ^HL or ~HL, Return RFID Data Log to Host, 385
- ^HR, Calibrate RFID Tag Position, 387
- ^RA, Read AFI Byte, 394
- ^RB, Define EPC Data Structure, 395
- ^RE, Enable/Disable E.A.S. Bit, 397
- ^RI, Get RFID Tag ID, 402
- ^RM, Enable RFID Motion, 405
- ^RN, Detect Multiple RFID Tags, 406
- ^RQ, Quick Write EPC Data and Passwords, 407
- ^RR, Specify RFID Retries for a Block, 409
- ^RS, RFID Setup, 411
- ^RT, Read RFID Tag, 418
- ^RU, read unique RFID chip serialization, 420
- ^RZ, Set RFID Tag Password and Lock Tag, 427
- ^WF, Write AFI Byte, 429
- ^WT, Write Tag, 430
- ^WV, Verify RFID Write Operation, 432
- ~RV, Report RFID Encoding Results, 422
- command compatibility with printers and firmware, 380

ZebraNet Alert

- halt, 351
- set, 356

ZPL

- set mode, 358

ZPL commands, 433

- ^B7, 77
- ~HQ, 258, 365
- ^MA, 296
- ^MI, 301
- Wireless Print Server commands, 1193, 1243
- ^XS, 376

ZPL ZBI command, 488



Zebra Technologies Corporation

Zebra Technologies Corporation
475 Half Day Road, Suite 500
Lincolnshire, IL 60069 USA
T: +1 847 634 6700
Toll-free +1 866 230 9494
F: +1 847 913 8766

Zebra Technologies Europe Limited

Dukes Meadow
Millboard Road
Bourne End
Buckinghamshire, SL8 5XF, UK
T: +44 (0)1628 556000
F: +44 (0)1628 556001

Zebra Technologies Asia Pacific, LLC

120 Robinson Road
#06-01 Parakou Building
Singapore 068913
T: +65 6858 0722
F: +65 6885 0838

<http://www.zebra.com>